

REVISONS		DATE	OWN	APVD
NO.	DESCRIPTION			
D4	REVISED PER ECO-11-005140	05APR2011	RK	HMR

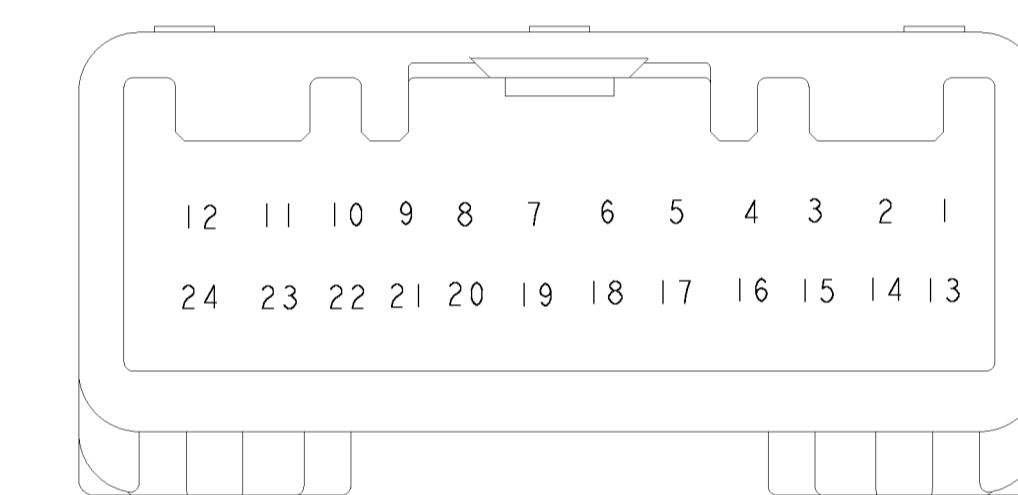
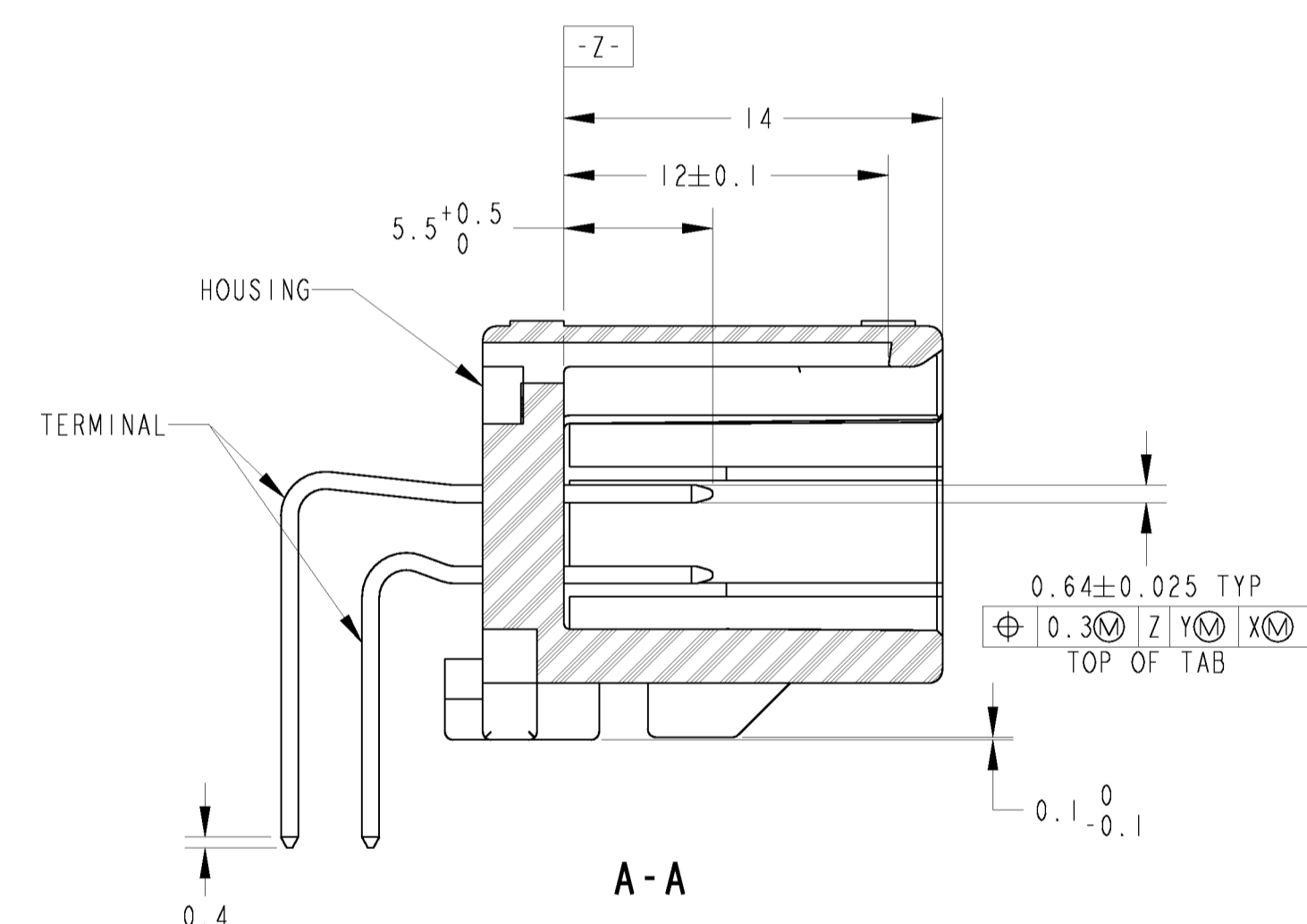
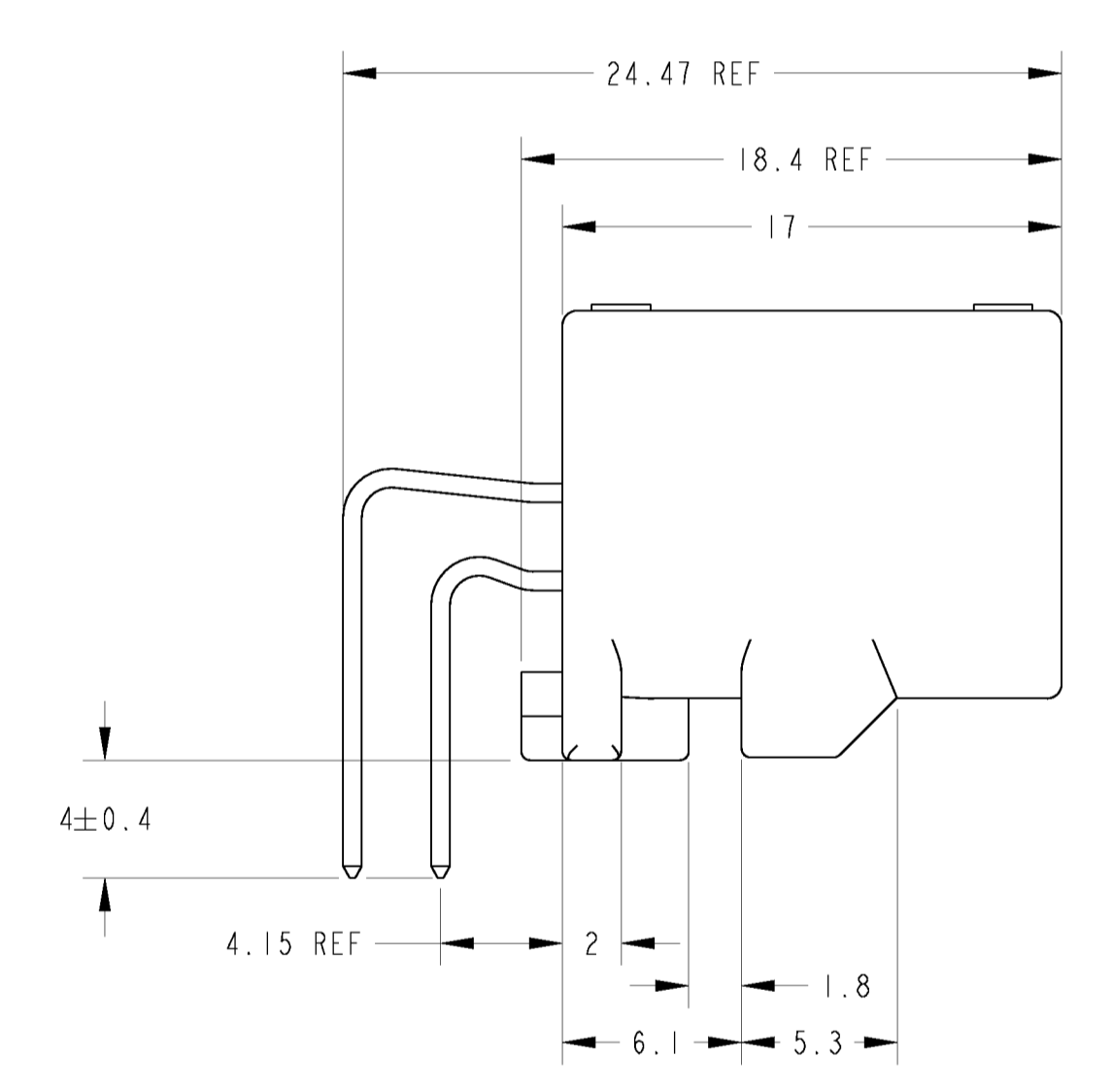
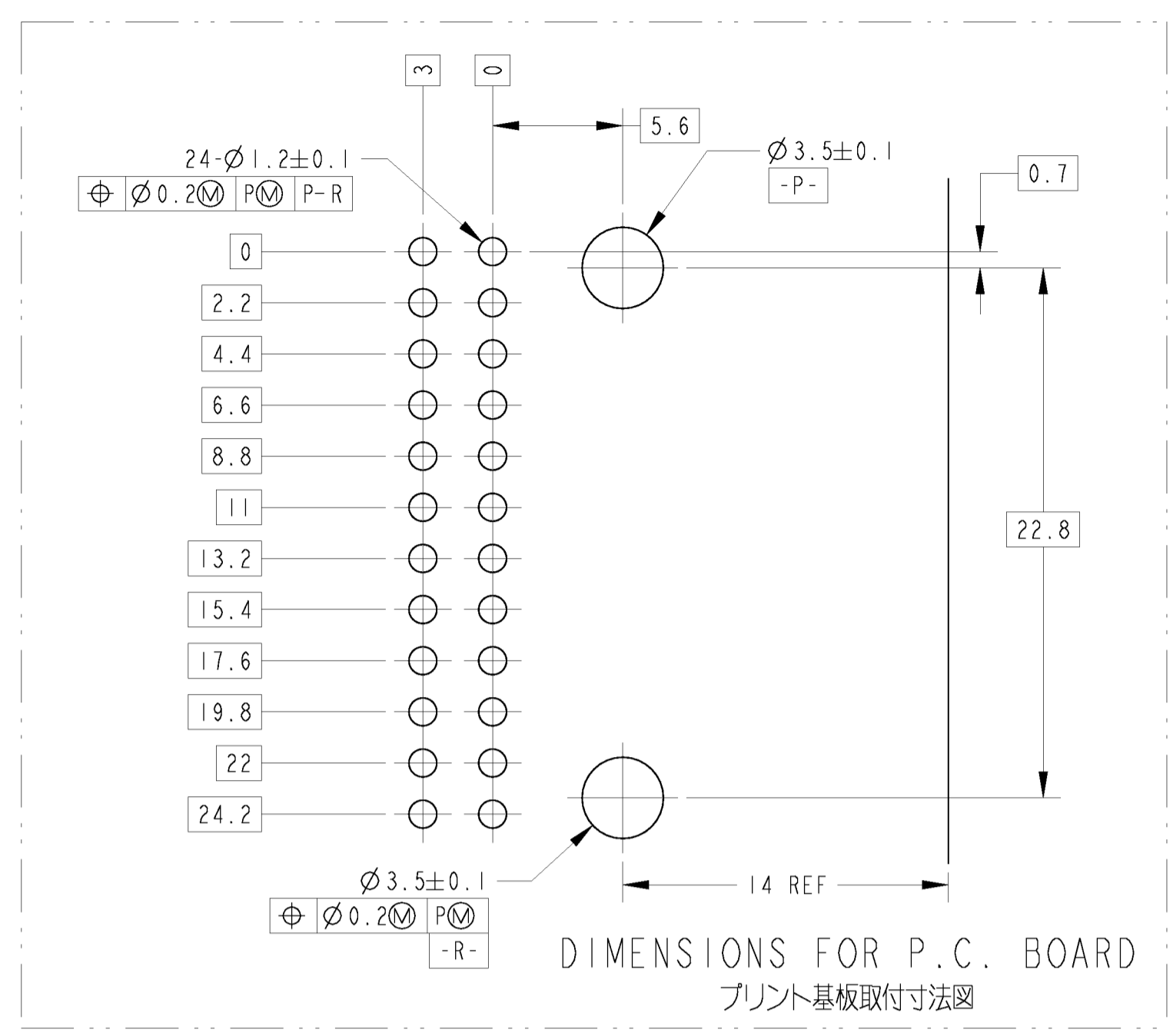
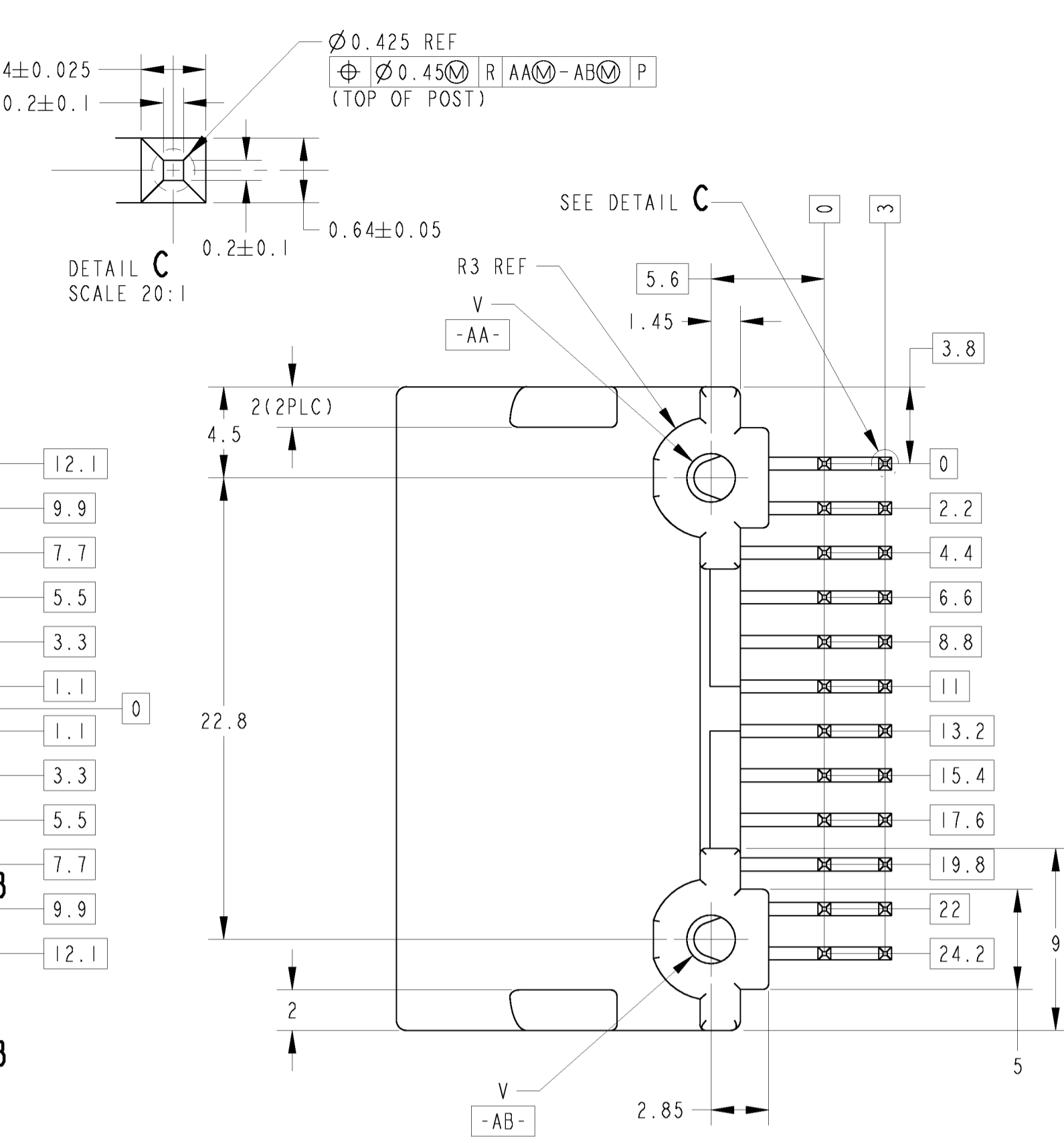
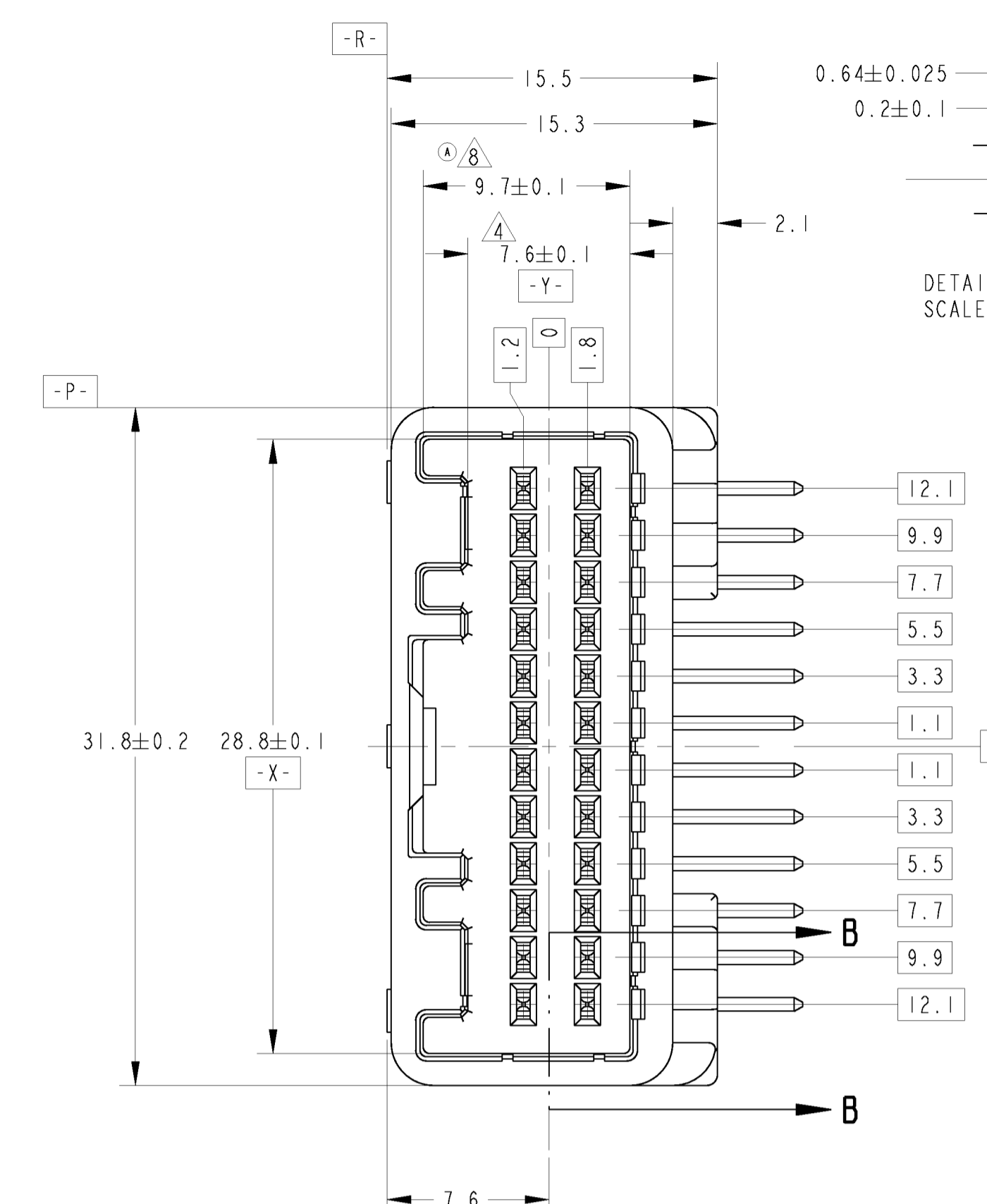
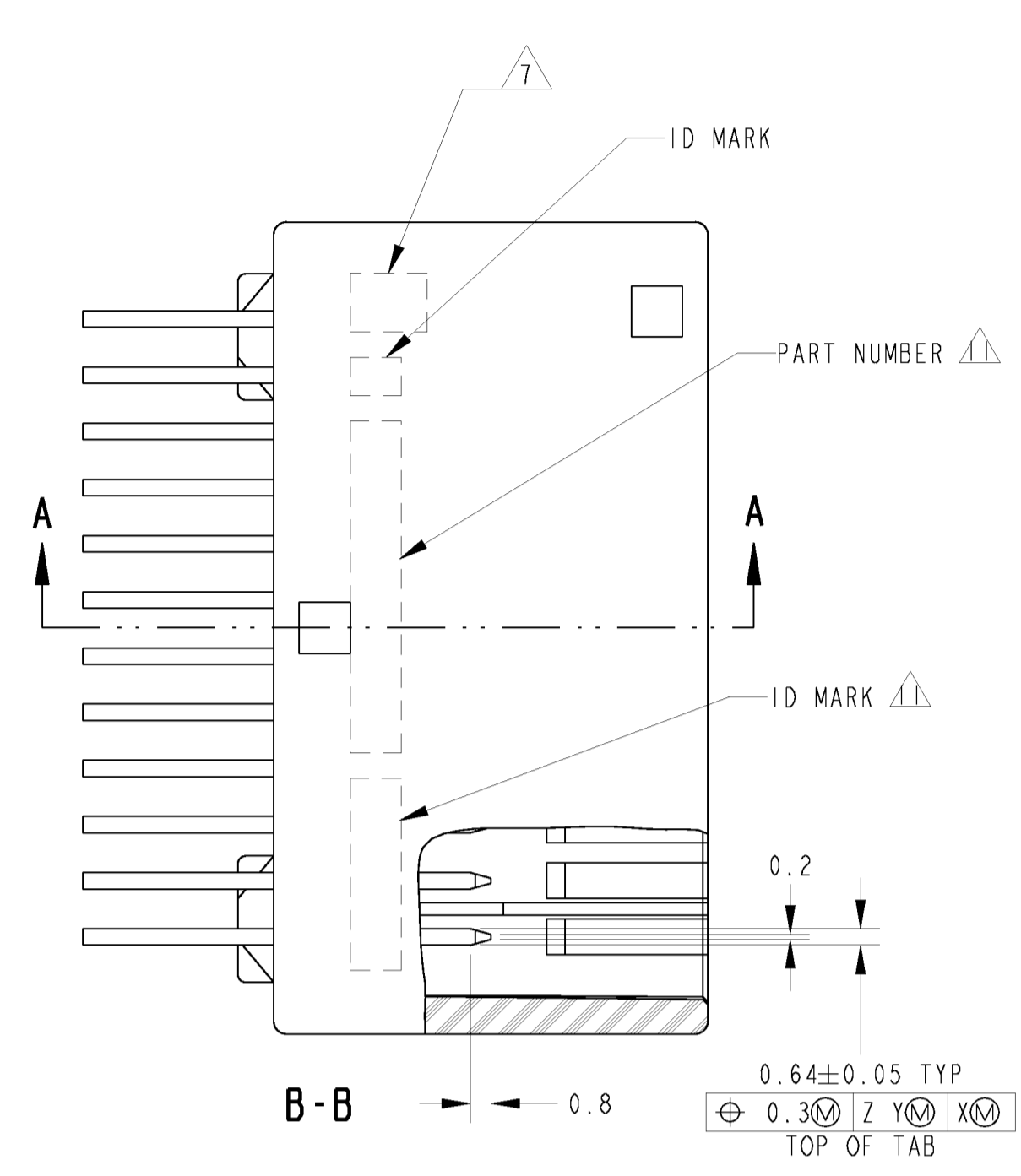

FIG. 1 回路番号
CIRCUIT NUMBER

- PART NUMBER OF HOUSING TO BE MATE : SEE TABLE -1 TO BE MATED SMOOTHLY WITH THE PLUG HOUSING ASSEMBLY
 - RECOMMENDED SCREW : PAN-HEADED TYPE 2 TAPPING SCREW, NOMINAL DIAMETER 3mm, LENGTH; SEE TABLE-3 (JIS B1115, B1122)
 - FASTENING TORQUE FOR SCREW : 0.392N·m MAX
 - MEASURED AT 6 mm FROM [-Z-]
 - INSTRUCTION SHEET NO : 411-5928
 - APPLIED TERMINAL : SEE TABLE -2
 - IDENTIFICATION MARK FOR THE CONTACT FINISH ; SEE TABLE
 - MEASURED AT 2 mm FROM [-Z-]
 - CIRCUIT NUMBER : SEE FIG.1
 - PRELIMINARY NOT RELEASED FOR PRODUCTION.
 - ID MARK, PART NUMBER INDICATED.
- 適合相手ハウジングは TABLE -1 参照
プラグハウジングアセンブリ(PN 1318917)と
変換なく適合すること
 - 推奨取付ねじ : JIS B1115, B1122タッピングねじ
なべノ種 取付径 3 , 長さ:TABLE-3参照
 - ねじ締め付トルク : 0.392N·m最大
 - [-Z-] 面から6mmの位置で測定
 - 取扱い説明書 NO : 411-5928
 - 適用端子は TABLE -2参照
 - コンタクト仕上識別記号 ; 表参照
 - [-Z-] 面から2mmの位置で測定
 - 回路番号 ; FIG.1 参照
 - 試作の数量はとられていない
 - ID MARK, PART NUMBERを表示.

TABLE -1

POS 種類	PLUG HOUSING PART NO
24	1318917

TABLE -2

SIGNAL	TIN	TERMINAL NO 端子番号	APPLICABLE WIRE RANGE (FEMALE) 適用電線(メス)
025	SELECTIVE GOLD	1123343-1	AVSS/AVSSH 0.3~0.5mm ²
		1123343-2	CAVS/CAVUS 0.22~0.5mm ²

TABLE -3

プリント基板板厚 (mm)	THICKNESS OF PCB (mm)	1.2	1.6
固定用ねじ留め長さ (mm)	NOMINAL LENGTH OF SCREW (mm)	5	6

MARKING マーキング	WEIGHT (g) 質量	V	PACKING STYLE 梱包形態	TOTAL NUMBER OF CIRCUIT 回路総数	SOLDERING SIDE 半田付け側	CONTACT SIDE 接触側	GOLD PLATED CIRCUIT NO (金めっき回路番号)	MATERIAL 材料	COLOR 色	PART NUMBER 製品番号
△6	5.6	Ø2.63	PLASTIC BOX 通い箱	PLASTIC TUBE プラスチックチューブ	24	SELECTIVE-TIN (MATTE)	SELECTIVE-TIN × 24 (BRIGHT)	---	---	SPS GF17 NATURAL 1-1318853-7
△0	4.5	Ø2.63	PAPER BOX タンボール箱	PLASTIC TUBE プラスチックチューブ	12	SELECTIVE-TIN (MATTE)	SELECTIVE GOLD × 12	1, 4, 7, 10~13 16, 19, 22~24	---	SPS GF17 BLACK 1-1318853-6
△6	5.6	Ø2.63	PAPER BOX タンボール箱	PLASTIC TUBE プラスチックチューブ	24	SELECTIVE-TIN (MATTE)	SELECTIVE-TIN × 24 (BRIGHT)	---	---	SPS GF17 NATURAL 1-1318853-3
-	6.0	Ø2.4	PAPER BOX タンボール箱	PLASTIC TUBE プラスチックチューブ	24	TIN-LEAD	SELECTIVE GOLD × 24	1~24	---	PBT GF15 NATURAL 1-1318853-2
5	5.1	Ø2.4	PAPER BOX タンボール箱	PLASTIC TUBE プラスチックチューブ	12	SELECTIVE TIN	SELECTIVE GOLD × 12	1, 4, 7, 10~13 16, 19, 22~24	---	PBT GF15 BLACK 1-1318853-1
5	5.1	Ø2.4	PAPER BOX タンボール箱	PLASTIC TUBE プラスチックチューブ	12	SELECTIVE-TIN	SELECTIVE GOLD × 12	1, 4, 7, 10~13 16, 19, 22~24	---	PBT GF15 NATURAL 1-1318853-0
4	5.1	Ø2.4	PLASTIC BOX 通い箱	PLASTIC TUBE プラスチックチューブ	12	SELECTIVE-TIN	SELECTIVE GOLD × 12	1, 4, 7, 10~13 16, 19, 22~24	---	PBT GF15 BLACK 1318853-9
4	5.1	Ø2.4	PLASTIC BOX 通い箱	PLASTIC TUBE プラスチックチューブ	12	SELECTIVE-TIN	SELECTIVE GOLD × 12	1, 4, 7, 10~13 16, 19, 22~24	---	PBT GF15 NATURAL 1318853-8
3	6.0	Ø2.4	PAPER BOX タンボール箱	PLASTIC TUBE プラスチックチューブ	24	TIN-LEAD	SELECTIVE GOLD × 24	1~24	---	PBT GF15 BLACK 1318853-5
3	6.0	Ø2.4	PLASTIC BOX 通い箱	PLASTIC TUBE プラスチックチューブ	24	TIN-LEAD	SELECTIVE GOLD × 24	1~24	---	PBT GF15 BLACK 1318853-4
2	6.0	Ø2.4	PLASTIC BOX 通い箱	PLASTIC TUBE プラスチックチューブ	24	TIN-LEAD	SELECTIVE GOLD × 4	3~6	---	PBT GF15 NATURAL 1318853-3
1	6.0	Ø2.4	PAPER BOX タンボール箱	PLASTIC TUBE プラスチックチューブ	24	PRE-TIN x 20	---	---	---	PBT GF15 NATURAL 1318853-2
1	6.0	Ø2.4	PLASTIC BOX 通い箱	PLASTIC TUBE プラスチックチューブ	24	PRE-TIN x 24	---	---	---	PBT GF15 NATURAL 1318853-1

THIS DRAWING IS A CONTROLLED DOCUMENT.

OWN Y. NOGUCHI OBMAROO
CHK N. SAI TOMAROO
APVD N. SAI TOMAROO

DIMENSIONS: mm
TOLERANCES UNLESS OTHERWISE SPECIFIED:
0-PLC ±0.3
1-PLC ±0.1
2-PLC ±0.05
3-PLC ±0.025
4-PLC ±0.001
ANGLES ±0° ±30°

MATERIAL CONTACT-BRASS HOUSING-SEE TABLE

FINISH SEE TABLE

WEIGHT SEE TABLE

CUSTOMER DRAWING

SIZE 4:1 SHEET 1 OF 2 REV D4

STE TE Connectivity

025 SERIES 24 POSITION(PCB H-TYPE) CAP HOUSING ASSEMBLY

114-5250

108-5668

114-5250

SEE TABLE

00779 1318853

LOC	DIST	REV	DESCRIPTION	DATE	DWN	APVD
J	-		SEE SHEET 1			

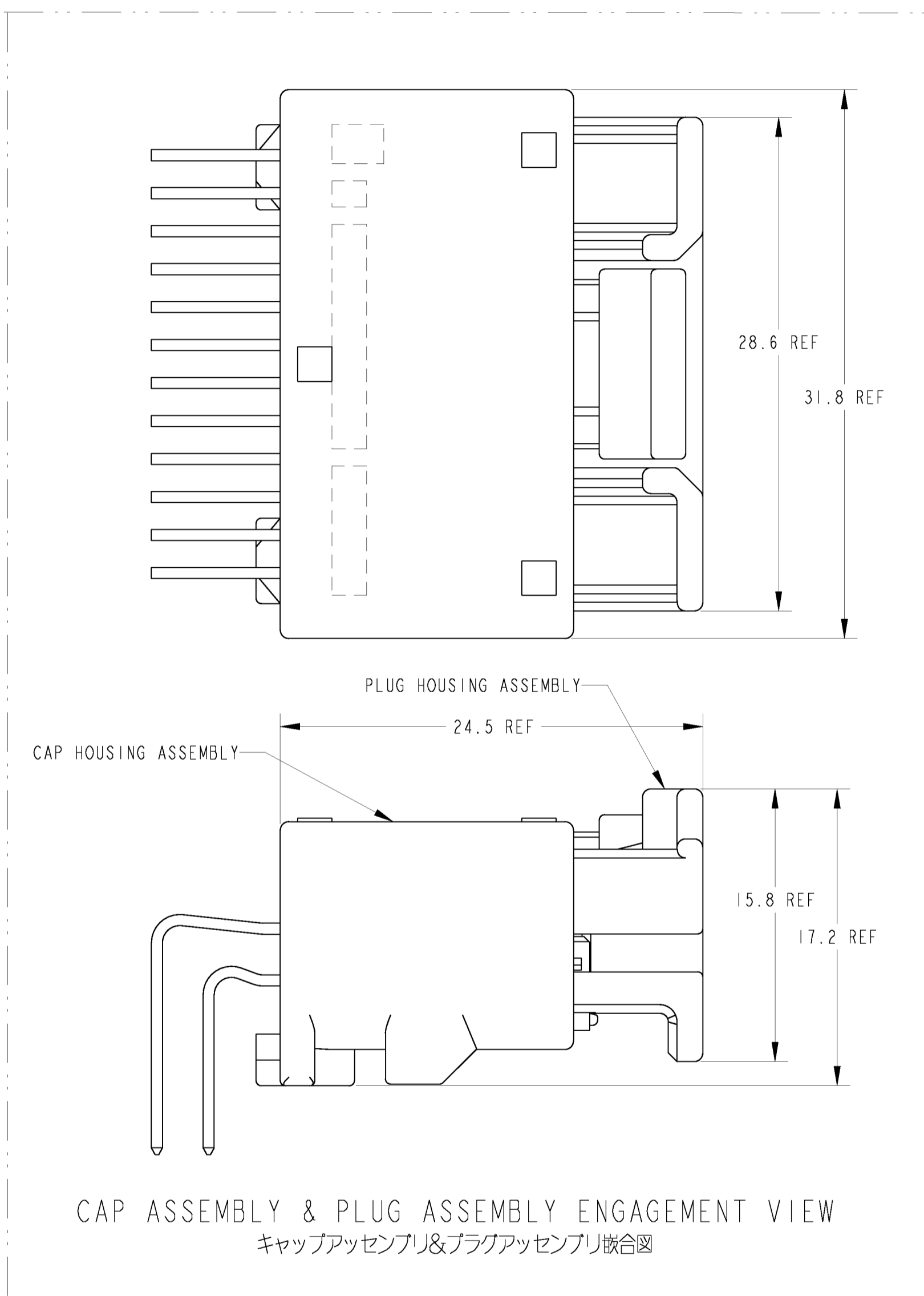

CAP ASSEMBLY & PLUG ASSEMBLY ENGAGEMENT VIEW
 キャップアセンブリ&プラグアセンブリ嵌合図

MARKING	WEIGHT (g)	V	OUTER 外装	INNER 内装	TOTAL NUMBER OF CIRCUIT 回路総数	SOLDERING SIDE 半田付け側	CONTACT SIDE 接点側	GOLD PLATED CIRCUIT NO. (金のついで回路番号)	MATERIAL 材料	COLOR 色	PART NUMBER 部品番号
△ 9	5.6	∅ 2.63	PLASTIC BOX 選い箱	PLASTIC TUBE プラスチックチューブ	24	SELECTIVE-TIN (MATTE)	SELECTIVE GOLD x 24	1~24	SPS GF17	NATURAL	2-1318853-7
△ 11	5.6	∅ 2.63	PLASTIC BOX 選い箱	PLASTIC TUBE プラスチックチューブ	24	SELECTIVE-TIN (MATTE)	SELECTIVE GOLD x 4 SELECTIVE-TIN(BRIGHT) x 20	3~6	SPS GF17	NATURAL	2-1318853-4
△ 10	4.5	∅ 2.63	PAPER BOX タンボール箱	PLASTIC TUBE プラスチックチューブ	12	SELECTIVE-TIN (MATTE)	SELECTIVE GOLD x 12	1, 4, 7, 10~13 16, 19, 22~24	SPS GF17	NATURAL	2-1318853-1
8	5.1	∅ 2.4	PLASTIC BOX 選い箱	PLASTIC TUBE プラスチックチューブ	12	SELECTIVE-TIN (MATTE)	SELECTIVE GOLD x 12	1, 4, 7, 10~13 16, 19, 22~24	PBT GF15	BLACK	2-1318853-0
8	5.1	∅ 2.4	PLASTIC BOX 選い箱	PLASTIC TUBE プラスチックチューブ	12	SELECTIVE-TIN (MATTE)	SELECTIVE GOLD x 12	1, 4, 7, 10~13 16, 19, 22~24	PBT GF15	NATURAL	1-1318853-9
△ 9	5.6	∅ 2.63	PAPER BOX タンボール箱	PLASTIC TUBE プラスチックチューブ	24	SELECTIVE-TIN (MATTE)	SELECTIVE GOLD x 24	1~24	SPS GF17	NATURAL	1-1318853-8
63	6.0	∅ 2.4	PAPER BOX タンボール箱	PLASTIC TUBE プラスチックチューブ	24	SELECTIVE-TIN (MATTE)	SELECTIVE GOLD x 24	1~24	PBT GF15	BLACK	6318853-5
63	6.0	∅ 2.4	PLASTIC BOX 選い箱	PLASTIC TUBE プラスチックチューブ	24	SELECTIVE-TIN (MATTE)	SELECTIVE GOLD x 24	1~24	PBT GF15	BLACK	6318853-4
62	6.0	∅ 2.4	PLASTIC BOX 選い箱	PLASTIC TUBE プラスチックチューブ	24	SELECTIVE-TIN (MATTE)	SELECTIVE GOLD x 4 SELECTIVE-TIN(BRIGHT) x 20	3~6	PBT GF15	NATURAL	6318853-3
MARKING マーキング	WEIGHT (g) 質量	V	PACKING STYLE 梱包形態			CONTACT FINISH コンタクト仕上					

THIS DRAWING IS A CONTROLLED DOCUMENT. DWN Y. NOGUCHI OSMAROO
 CHK N. SAI TOMAROO
 DIMENSIONS: 単位: mm TOLERANCES UNLESS OTHERWISE SPECIFIED: 公差
 0 PLC ±0.1
 1 PLC ±0.05
 2 PLC ±0.025
 3 PLC ±0.025
 4 PLC ±0.001
 ANGLES 114-5250
 MATERIAL CONTACT-BRASS HOUSING-SEE TABLE FINISH SEE TABLE WEIGHT SEE TABLE
 CUSTOMER DRAWING
STE TE Connectivity
 025 SERIES 24 POSITION(PCB H-TYPE) CAP HOUSING ASSEMBLY
 SIZE CAGE CODE DRAWING NO RESTRICTED TO
 A1 00779 C=1318853
 SHEET 2 OF 2 REV D4