



Brand of NTN Group

Technical data

UCF211T20

Bearing units



Grey cast housing, radial insert ball bearing with socket set screws, labyrinth seal, for high-temp. applications

KIT CONTENT

UC211G2T20, F211

VISUAL (S)

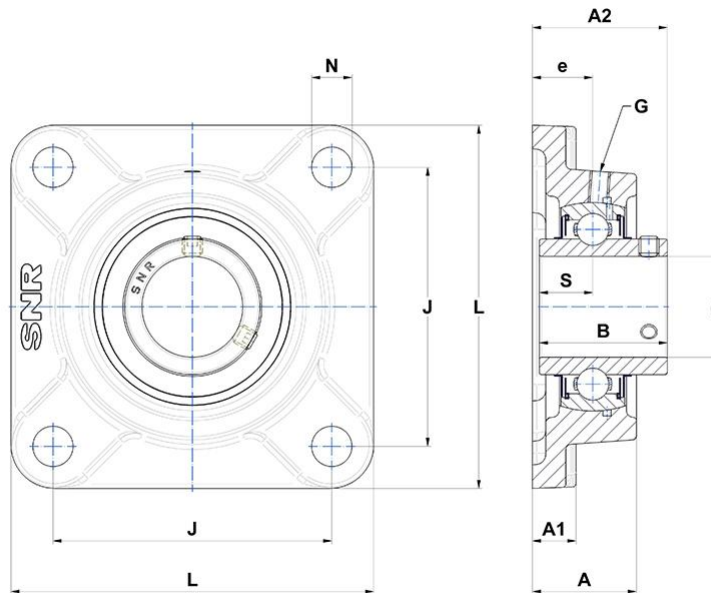

PRODUCT DEFINITION

Brand	SNR
A - Housing height	43 mm
A1 - Housing foot height / flange height	18 mm
A2 - Total height from mounting surface	58,4 mm
B - Width of Inner Ring	55,6 mm



NTN Europe

1 rue des Usines · BP 2017 · 74010 Annecy Cedex · France · Tel. +33 (0)4 50 65 30 00
S.A. au capital de 322 639 919 € · RCS ANNECY B 325 821 072 · Id. Fiscale : FR 48 325 821 072
SIRET 325 821 072 00015 · Code APE 2815 Z · Code NACE 28.15

PRODUCT DEFINITION

d - Shaft diameter	55 mm
e - Distance mounting surface to bearing center	25 mm
G - Grease fitting	M6x1
J - Mounting holes distance	130 mm
L - Housing width / diameter	162 mm
N - Mounting hole dimension	19 mm
S - Distance front side/bearing centre	22,2 mm

PRODUCT PERFORMANCE

C - Dynamic load rating	43550000 mN
C0 - Static load rating	29200000 mN
Operating temperature min.	253,15 °K
Operating temperature max.	473,15 °K

OTHER FEATURES

Mass	3,31 kg
Recommended tightening torque for set screw	22 N-m

