

# Network cable - NBC-MSD/ 2,0-93E/R4MC SCO



1407365

<https://www.phoenixcontact.com/gb/products/1407365>

Please be informed that the data shown in this PDF document is generated from our Online Catalog. Please find the complete data in the user documentation. Our General Terms of Use for Downloads are valid.



Network cable, Ethernet CAT5 (100 Mbps), 4-position, shielded, Plug straight M12 SPEEDCON / IP67, coding: D, on Plug straight RJ45 Clip locking / IP67, cable length: 2 m

## Commercial Data

Item number	1407365
Packing unit	1 pc
Minimum order quantity	1 pc
Sales Key	BF1CJI
Product Key	BF1CJI
Catalog Page	Page 399 (C-2-2019)
GTIN	4046356774932
Weight per Piece (including packing)	133.8 g
Weight per Piece (excluding packing)	133.8 g
Customs tariff number	85444210
Country of origin	PL

## Technical Data

### Notes

General	Further products with variable cable type and variable cable length can be found in the accessories section
---------	---

### Product properties

Product type	Data cable preassembled
Number of positions	4
Application	Standard
Shielded	yes
Coding	D - data

### Interfaces

Bus system	Ethernet
Signal type/category	Ethernet CAT5 (IEC 11801), 100 Mbps

### LED signaling

Status display	No
Status display present	No

### Electrical properties

Nominal voltage $U_N$	48 V AC
	60 V DC
Nominal current $I_N$	1 A
Transmission medium	Copper

### Material specifications

Color Handle area	gray / black
Material of grip body	TPU, hardly inflammable, self-extinguishing
Contact material	CuSn
Contact surface material	Ni/Au
Contact carrier material	TPU GF
Cable gland material	Zinc die-cast, nickel-plated
Housing material	Plastic

### Connector

#### Header 1

Type	Plug straight M12 SPEEDCON / IP67
Number of positions	4
Coding type	D (Data)
Handle color	black
Material	CuZn (Contact) Ni/Au (Contact surface)

# Network cable - NBC-MSD/ 2,0-93E/R4MC SCO



1407365

<https://www.phoenixcontact.com/gb/products/1407365>

	PA (Contact carriers)
	TPU, hardly inflammable, self-extinguishing (Grip)
	Zinc die-cast, nickel-plated (Screw connection)
Insertion/withdrawal cycles	≥ 100
Contact resistance	≤ 5 mΩ
Insulation resistance	≥ 100 MΩ
Tightening torque	0.4 Nm
Degree of protection	IP67
Ambient temperature (operation)	-25 °C ... 90 °C

## Head 2

Type	Plug straight RJ45 Clip locking / IP67
Number of positions	4 (8)
Handle color	gray
Material	CuSn (Contact) Ni/Au (Contact surface) PC (Contact carriers) PA (Housing)
Insertion/withdrawal cycles	≥ 750
Ambient temperature (operation)	-20 °C ... 70 °C

## Cable / line

Cable length	2 m
Cable weight	42 kg/km
UL AWM Style	20963 (80°C/30 V)
Number of positions	4
Shielded	yes
Cable type	Ethernet flexible CAT5, 2-pair [93E]
Signal runtime	5.3 ns/m
Conductor structure signal line	7x 0.16 mm
AWG signal line	26
Conductor cross section	2x 2x 0.14 mm <sup>2</sup>
Wire diameter incl. insulation	0.98 mm
External cable diameter	6.4 mm ±0.2 mm
Outer sheath, material	PUR
External sheath, color	water blue RAL 5021
Conductor material	Bare Cu litz wires
Material wire insulation	Foamed PE
Single wire, color	white/orange-orange, white/green-green
Thickness, outer sheath	1.2 mm
Twisted pairs	2 cores to the pair
Overall twist	Two pairs with two fillers to the core
Optical shield covering	70 %
Insulation resistance	≥ 500 MΩ*km

# Network cable - NBC-MSD/ 2,0-93E/R4MC SCO



1407365

<https://www.phoenixcontact.com/gb/products/1407365>

Coupling resistance	≤ 100.00 mΩ/m (at 10 MHz)
Loop resistance	≤ 290.00 Ω/km
Wave impedance	100 Ω ±5 Ω (at 100 MHz)
Cable capacity	approx. 45 nF/km (at 1 kHz)
Nominal voltage, cable	≤ 100 V (Peak value, not for high-power applications)
Test voltage Core/Core	700 V (50 Hz, 1 min.)
Test voltage Core/Shield	700 V (50 Hz, 1 min.)
Current carrying capacity of cable	2 A (according to DIN VDE 0891-1)
Minimum bending radius, fixed installation	4 x D
Minimum bending radius, flexible installation	8 x D
Tensile strength	≤ 80 N
Near end crosstalk attenuation (NEXT)	65.3 dB (with 1 MHz)
	56.3 dB (at 4 MHz)
	50.3 dB (at 10 MHz)
	47.2 dB (at 16 MHz)
	45.8 dB (at 20 MHz)
	42.9 dB (at 31.25 MHz)
	38.4 dB (at 62.5 MHz)
	35.3 dB (at 100 MHz)
Power-summated near end crosstalk attenuation (PSNEXT)	62.3 dB (with 1 MHz)
	53.3 dB (at 4 MHz)
	47.3 dB (at 10 MHz)
	44.2 dB (at 16 MHz)
	42.8 dB (at 20 MHz)
	39.9 dB (at 31.25 MHz)
	35.4 dB (at 62.5 MHz)
	32.3 dB (at 100 MHz)
Return loss (RL)	23 dB (at 4 MHz)
	24.1 dB (at 8 MHz)
	25 dB (at 10 MHz)
	25 dB (at 16 MHz)
	25 dB (at 20 MHz)
	23.6 dB (at 31.25 MHz)
	21.5 dB (at 62.5 MHz)
	20.1 dB (at 100 MHz)
Shield attenuation	3.2 dB (with 1 MHz)
	6 dB (at 4 MHz)
	9.5 dB (at 10 MHz)
	12.1 dB (at 16 MHz)
	13.6 dB (at 20 MHz)
	17.1 dB (at 31.25 MHz)
	24.8 dB (at 62.5 MHz)
	32 dB (at 100 MHz)
Halogen-free	according to IEC 60754-1

# Network cable - NBC-MSD/ 2,0-93E/R4MC SCO



1407365

<https://www.phoenixcontact.com/gb/products/1407365>

Flame resistance	according to IEC 60332-1-2
	in acc. to UL VW1
Resistance to oil	according to EN 60811-2-1
Ambient temperature (operation)	-40 °C ... 80 °C (cable, fixed installation)
	-20 °C ... 80 °C (Cable, flexible installation)
Ambient temperature (installation)	-20 °C ... 80 °C

## Cable structure

Signal type/category	Ethernet CAT5 (IEC 11801), 100 Mbps
----------------------	-------------------------------------

## Ambient conditions

Degree of protection	IP65 (M12 connector)
	IP67 (M12 connector)
	IP67 (RJ45 connector)
Degree of protection	IP65/IP67

## Standards and regulations

### M12

Standards/specifications	IEC 61076-2-101
--------------------------	-----------------

1407365

<https://www.phoenixcontact.com/gb/products/1407365>

## Drawings

Circuit diagram

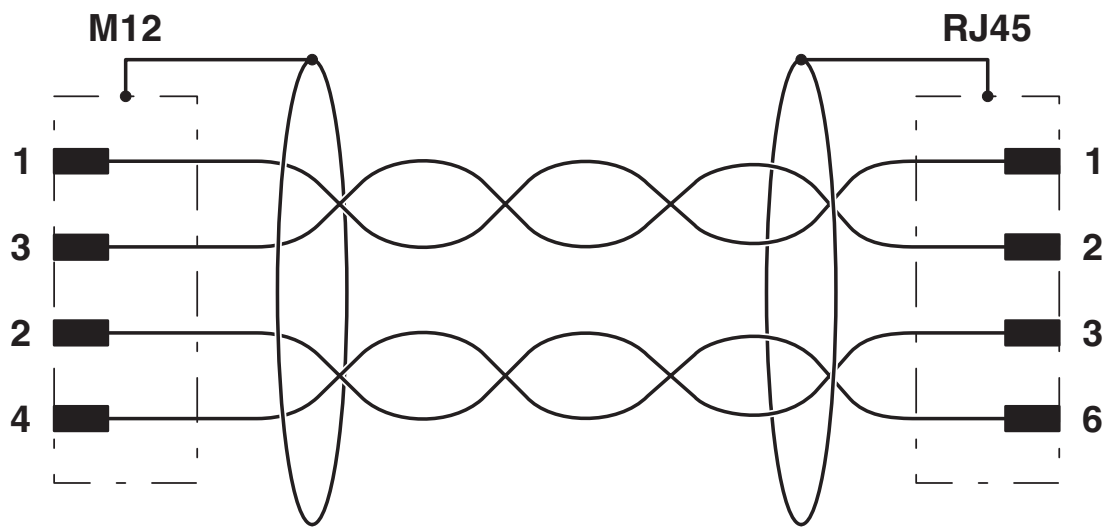

Contact assignment of the M12 and RJ45 plug

Dimensional drawing

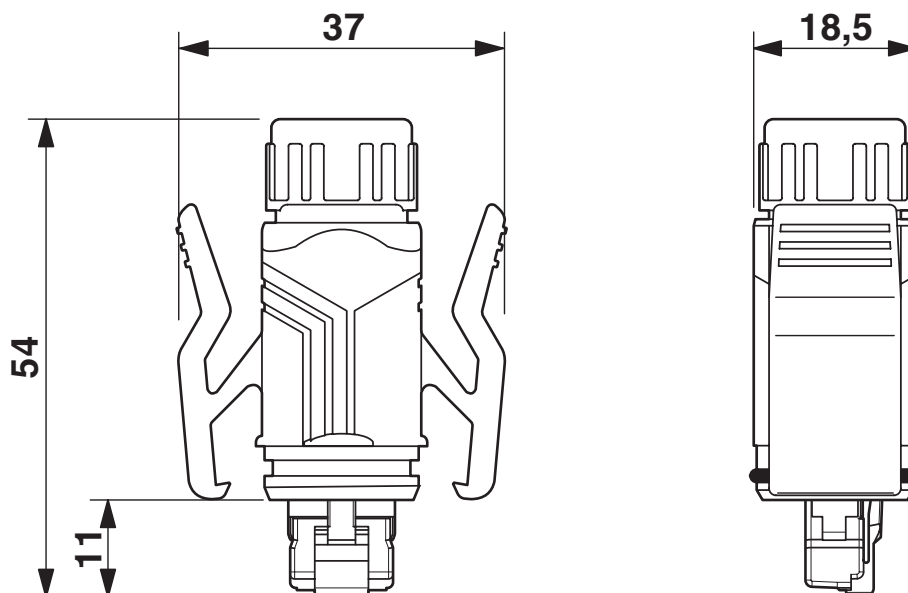

RJ45-connector, IP67

# Network cable - NBC-MSD/ 2,0-93E/R4MC SCO

1407365

<https://www.phoenixcontact.com/gb/products/1407365>



Schematic diagram

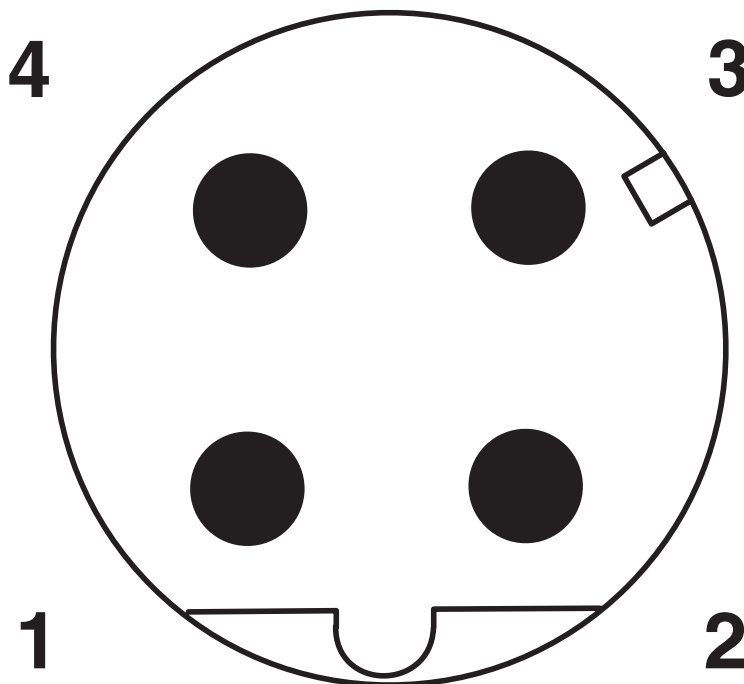

Pin assignment M12 male connector, 4-pos., D-coded, male side

# Network cable - NBC-MSD/ 2,0-93E/R4MC SCO

1407365

<https://www.phoenixcontact.com/gb/products/1407365>



Schematic diagram

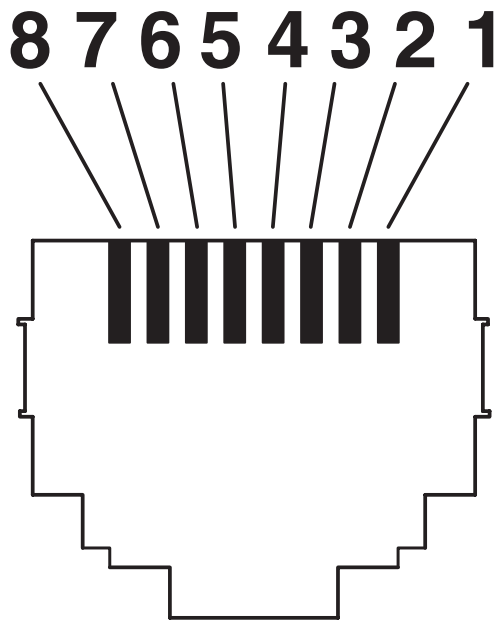

Connector pin assignment plug RJ45



# Network cable - NBC-MSD/ 2,0-93E/R4MC SCO

1407365

<https://www.phoenixcontact.com/gb/products/1407365>

Dimensional drawing

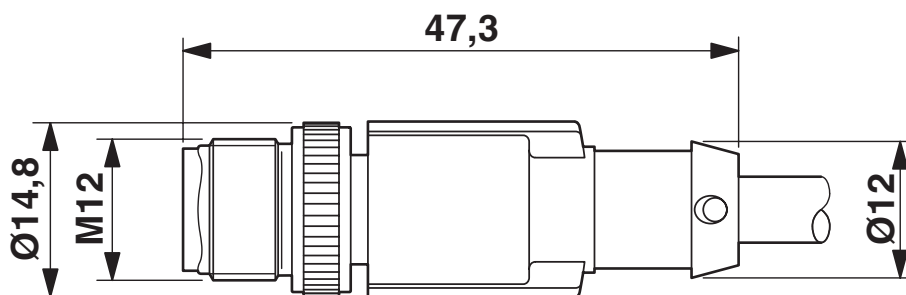

Plug, M12 x 1, straight, shielded

# Network cable - NBC-MSD/ 2,0-93E/R4MC SCO



1407365

<https://www.phoenixcontact.com/gb/products/1407365>

## Approvals



**EAC**

Approval ID: RU D-DE.HB35.B.00387

# Network cable - NBC-MSD/ 2,0-93E/R4MC SCO



1407365

<https://www.phoenixcontact.com/gb/products/1407365>

## Classifications

### ECLASS

ECLASS-9.0	27060308
ECLASS-10.0.1	27060308
ECLASS-11.0	27060307

### ETIM

ETIM 8.0	EC001855
----------	----------

### UNSPSC

UNSPSC 21.0	26121600
-------------	----------

# Network cable - NBC-MSD/ 2,0-93E/R4MC SCO



1407365

<https://www.phoenixcontact.com/gb/products/1407365>

## Environmental Product Compliance

REACH SVHC	Lead 7439-92-1
China RoHS	Environmentally Friendly Use Period = 50 years
	For information on hazardous substances, refer to the manufacturer's declaration available under "Downloads"

# Network cable - NBC-MSD/ 2,0-93E/R4MC SCO

1407365

<https://www.phoenixcontact.com/gb/products/1407365>

## Accessories

### Network cable

Network cable - NBC-MSD-R4MC SCO/.../... - 1408710

<https://www.phoenixcontact.com/gb/products/1408710>



Network cable, Ethernet CAT5 (100 Mbps), 4-position, Variable cable type, shielded, Plug straight M12 SPEEDCON / IP67, coding: D, on Plug straight RJ45 Clip locking / IP67, cable length: Free input (0.2 ... 40.0 m)

---

### Torque screwdriver

Torque screwdriver - TSD 04 SAC - 1208429

<https://www.phoenixcontact.com/gb/products/1208429>



Torque screwdriver, with preset torque of 0.4 Nm and 4 mm hexagonal drive for M12 connectors

# Network cable - NBC-MSD/ 2,0-93E/R4MC SCO



1407365

<https://www.phoenixcontact.com/gb/products/1407365>

## Network cable

Network cable - NBC-MRD-R4MC SCO/.../... - 1408703

<https://www.phoenixcontact.com/gb/products/1408703>

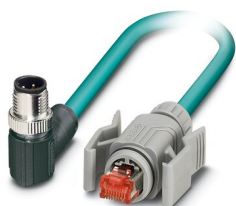

Network cable, Ethernet CAT5 (100 Mbps), 4-position, Variable cable type, shielded, Plug angled M12 SPEEDCON / IP67, coding: D, on Plug straight RJ45 Clip locking / IP67, cable length: Free input (0.2 ... 40.0 m)

---

## Torque screwdriver

Torque screwdriver - TSD-M 1,2NM - 1212224

<https://www.phoenixcontact.com/gb/products/1212224>



Torque screw driver, accuracy as per EN ISO 6789 standard, adjustable from 0.3 - 1.2 Nm

# Network cable - NBC-MSD/ 2,0-93E/R4MC SCO



1407365

<https://www.phoenixcontact.com/gb/products/1407365>

## Network cable

Network cable - NBC-FSD-R4MC SCO/.../... - 1408695

<https://www.phoenixcontact.com/gb/products/1408695>

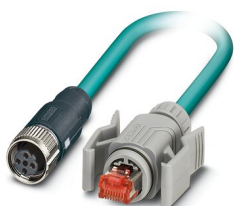

Network cable, Ethernet CAT5 (100 Mbps), 4-position, Variable cable type, shielded, Plug straight RJ45 Clip locking / IP67, on Socket straight M12 SPEEDCON / IP67, coding: D, cable length: Free input (0.2 ... 40.0 m)

---

## Adapter insert

Adapter insert - TSD-M SAC-BIT ADAPTER - 1212600

<https://www.phoenixcontact.com/gb/products/1212600>



Adapter bit for TSD-M...torque tools, E6.3-1/4" drive with 4 mm hexagon to accommodate SAC bits

# Network cable - NBC-MSD/ 2,0-93E/R4MC SCO



1407365

<https://www.phoenixcontact.com/gb/products/1407365>

## Network cable

Network cable - NBC-FRD-R4MC SCO/.../... - 1408688

<https://www.phoenixcontact.com/gb/products/1408688>

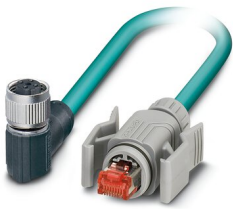

Network cable, Ethernet CAT5 (100 Mbps), 4-position, Variable cable type, shielded, Plug straight RJ45 Clip locking / IP67, on Socket angled M12 SPEEDCON / IP67, coding: D, cable length: Free input (0.2 ... 40.0 m)

---

## Tool

Tool - SAC BIT M12-D15 - 1208432

<https://www.phoenixcontact.com/gb/products/1208432>



Nut for assembling sensor/actuator cables with M12 connector and M12 connectors for assembly, with a knurl diameter of 15 mm, for 4 mm hexagonal drive



# Network cable - NBC-MSD/ 2,0-93E/R4MC SCO



1407365

<https://www.phoenixcontact.com/gb/products/1407365>

## Sealing cap

Sealing cap - PROT-M12 FS-PA-CHAIN - 1430873

<https://www.phoenixcontact.com/gb/products/1430873>

M12 sealing cap made of plastic with fixing band, for sensor cables, for free M12 plugs



---

## Locking clip

Locking clip - SAC-M12-EXCLIP-M - 1558988

<https://www.phoenixcontact.com/gb/products/1558988>

Locking clip for the pin side of sensor/actuator cables with M12 connector and M12 connectors for assembly, for knurl diameter: 15 mm or for Allen key with a wrench size of 14 mm, prevents the disconnection of plug-in connections without tools



---

Phoenix Contact 2022 © - all rights reserved  
<https://www.phoenixcontact.com>

PHOENIX CONTACT Ltd  
Halesfield 13, Telford  
Shropshire, TF7 4PG  
01952 681700  
[info@phoenixcontact.co.uk](mailto:info@phoenixcontact.co.uk)