

# General-purpose Basic Switch

## A

### High-capacity Switch Capable of Handling 20 A Loads with Large Inrush Currents

- Same shape as OMRON Z Basic Switches except in pin plunger position, yet endures inrush currents as large as 75 A.

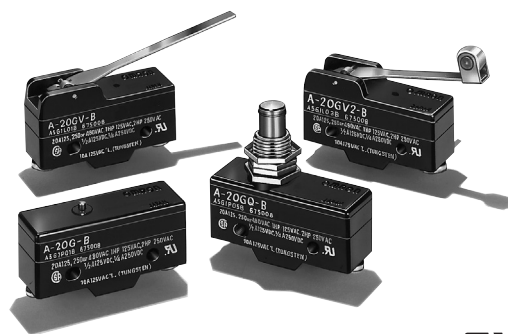

## Model Number Structure

### ■ Model Number Legend

A-20G□-□  
1 2 3 4

#### 1. Ratings

20: 20 A (250 VAC)

#### 2. Contact Gap

G: 0.5 mm

#### 3. Actuator

None: Pin plunger

D: Short spring plunger

Q: Panel mount plunger

Q21: Panel mount cross roller plunger

Q22: Panel mount roller plunger

V: Hinge lever

V2: Hinge roller lever

V21: Short hinge lever

V22: Short hinge roller lever









#### 4. Terminals

None: Solder terminal

B: Screw terminal (with toothed washer)

## Ordering Information

### ■ List of Models

Actuator	Solder terminal	Screw terminal (-B)
Pin plunger 	A-20G	A-20G-B
Short spring plunger 	A-20GD	A-20GD-B
Panel mount plunger 	A-20GQ	A-20GQ-B
Panel mount roller plunger 	A-20GQ22	A-20GQ22-B
Panel mount cross roller plunger 	---	A-20GQ21-B
Short hinge lever 	A-20GV21	A-20GV21-B
Hinge lever 	A-20GV	A-20GV-B
Short hinge roller lever 	A-20GV22	A-20GV22-B
Hinge roller lever 	A-20GV2	A-20GV2-B

**Note:** Refer to *Terminals* in Model Z for solder and screw terminals.

## Specifications

### ■ Approved Standards

Agency	Standard	File No.
UL	UL508	E41515
CSA	CSA C22.2 No. 55	LR21642

### ■ Approved Standard Ratings

**UL508 (File No. E41515)**

**CSA C22.2 No.55 (File No. LR21642)**

Rated voltage	A-20G
125 VAC	1 HP 10 A "L"
250 VAC	2 HP
480 VAC	20 A
125 VDC	0.5 A
250 VDC	0.25 A

## ■ Ratings

Rated voltage	Non-inductive load				Inductive load			
	Resistive load		Lamp load		Inductive load		Motor load	
	NC	NO	NC	NO	NC	NO	NC	NO
125 VAC	20 A		7.5 A		20 A		12.5 A	
250 VAC	20 A		7.5 A		20 A		8.3 A	
500 VAC	15 A		4 A		10 A		2 A	
8 VDC	20 A		3 A	1.5 A	20 A		12.5 A	
14 VDC	20 A		3 A	1.5 A	15 A		12.5 A	
30 VDC	6 A		3 A	1.5 A	5 A		5 A	
125 VDC	0.5 A		0.5 A		0.05 A		0.05 A	
250 VDC	0.25 A		0.25 A		0.03 A		0.03 A	

- Note:**
- The above values are for steady-state current.
  - Inductive load has a power factor of 0.4 min. (AC) and a time constant of 7 ms max. (DC).
  - Lamp load has an inrush current of 10 times the steady-state current.
  - Motor load has an inrush current of 6 times the steady-state current.
  - The ratings values apply under the following test conditions:  
 Ambient temperature: 20±2°C  
 Ambient humidity: 65±5%  
 Operating frequency: 20 operations/min

## ■ Characteristics

Operating speed	0.01 mm to 1 m/s (see note 1)
Operating frequency	Mechanical: 240 operations/min Electrical: 20 operations/min (under rated load)
Insulation resistance	100 MΩ min. (at 500 VDC)
Contact resistance	15 mΩ max. (initial value)
Dielectric strength	1,000 VAC, 50/60 Hz for 1 min between terminals of the same polarity 2,000 VAC, 50/60 Hz for 1 min between the current-carrying metal parts and the ground, and between each terminal and non-current-carrying metal parts
Vibration resistance	Malfunction: 10 to 55 Hz, 1.5-mm double amplitude (see note 2)
Shock resistance	Destruction: 1,000 m/s <sup>2</sup> {approx. 100G} max. Malfunction: 300 m/s <sup>2</sup> {approx. 30G} max. (see note 1, 2)
Durability	Mechanical: 1,000,000 operations min. Electrical: 500,000 operations min.
Degree of protection	IP00
Degree of protection against electric shock	Class I
Proof tracking index (PTI)	175
Switch category	D (IEC335-1)
Ambient temperature	Operating: -25°C to 80°C (with no icing)
Ambient humidity	Operating: 35% to 85%
Weight	Approx. 23 to 58 g

- Note:**
- The value is for the pin plunger. (Contact your OMRON representative for other models.)
  - Malfunction: 1 ms max.

## ■ Contact Form (SPDT)

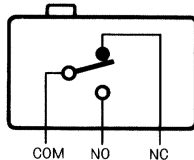

## Contact Specification

Item		A-20
Contacts	Shape	Rivet
	Material	Silver alloy
	Gap (standard value)	0.5 mm
Inrush current	NC	75 A max.
	NO	75 A max.

## Engineering Data

### Mechanical Durability

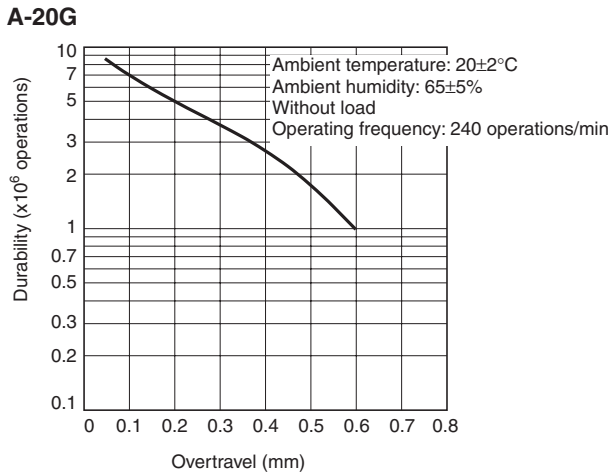

### Electrical Durability

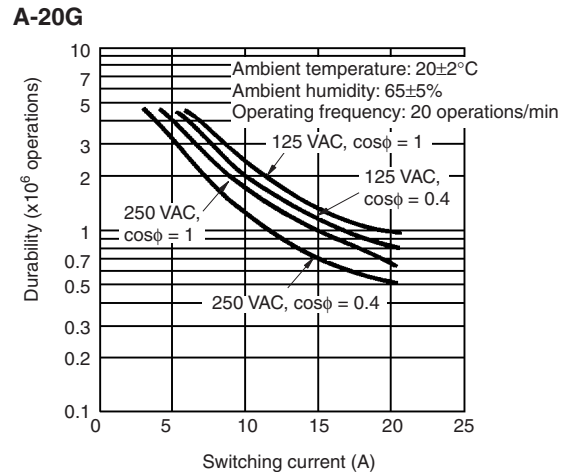

## Dimensions

- Note:** 1. All units are in millimeters unless otherwise indicated.  
 2. Unless otherwise specified, a tolerance of ±0.4 mm applies to all dimensions.

### Dimensions and Operating Characteristics

The models, illustrations, and graphics are for screw-terminal models. (The dimensions for models that are omitted here are the same as for pin-plunger models.)

#### Pin Plunger A-20G-B

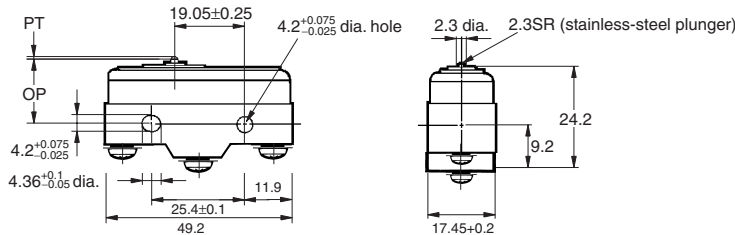

<b>OF</b>	3.92 to 6.13 N {400 to 625 gf}
<b>RF min.</b>	2.79 N {285 gf}
<b>PT max.</b>	1.3 mm
<b>OT min.</b>	0.25 mm
<b>MD max.</b>	0.2 mm
<b>OP</b>	16.3±0.4 mm

#### Short Spring Plunger A-20GD-B

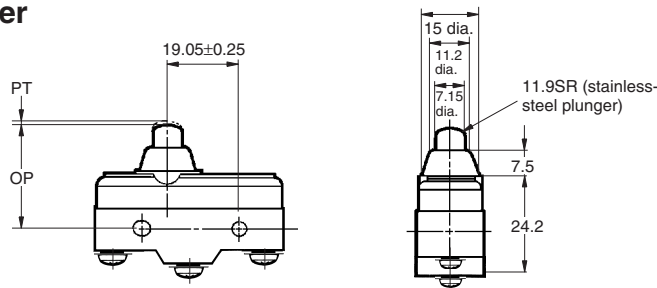
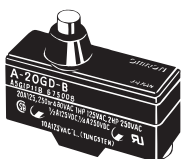

<b>OF</b>	3.92 to 6.13 N {400 to 625 gf}
<b>RF min.</b>	2.79 N {285 gf}
<b>PT max.</b>	1.3 mm
<b>OT min.</b>	3 mm
<b>MD max.</b>	0.2 mm
<b>OP</b>	26.2±0.5 mm

### Panel Mount Plunger

A-20GQ-B

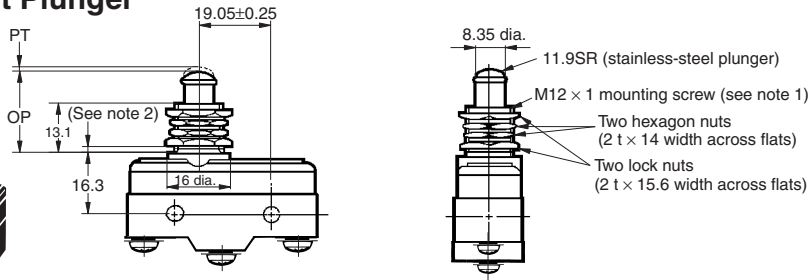
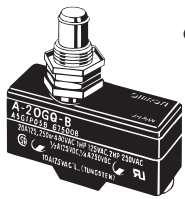

<b>OF</b>	3.92 to 6.13 N {400 to 625 gf}
<b>RF min.</b>	2.79 N (285 gf)
<b>PT max.</b>	1.3 mm
<b>OT min.</b>	5.6 mm
<b>MD max.</b>	0.2 mm
<b>OP</b>	21.8 ± 0.8 mm

- Note:** 1. Do not use both M12 mounting screw and mounting holes at the same time.  
 2. Imperfect screw part with a maximum length of 1.5 mm.

### Panel Mount Roller Plunger

A-20GQ22-B

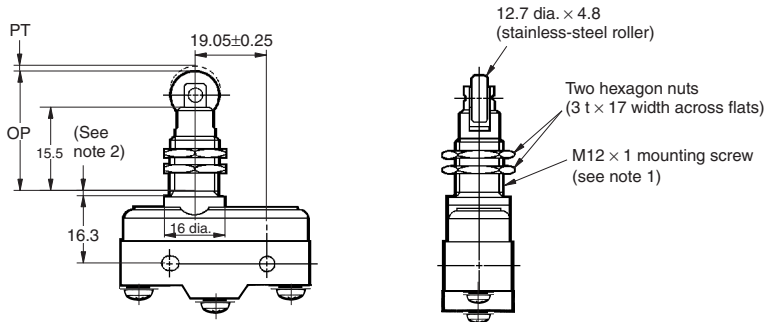
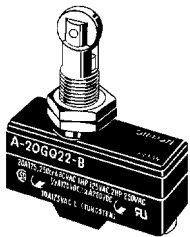

<b>OF</b>	6.18 N {630 gf} max.
<b>RF min.</b>	2.75 N {280 gf}
<b>PT max.</b>	1.3 mm
<b>OT min.</b>	3.58 mm
<b>MD max.</b>	0.35 mm
<b>OP</b>	33.4 ± 1.2 mm

- Note:** 1. Do not use both M12 mounting screw and mounting holes at the same time.  
 2. Imperfect screw part with a maximum length of 1.5 mm.

### Panel Mount Cross Roller Plunger

A-20GQ21-B

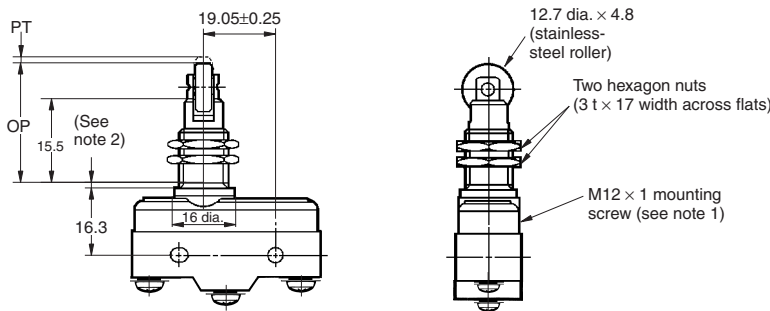
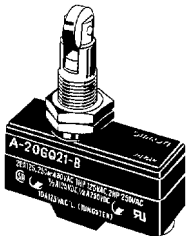

<b>OF</b>	6.18 N {630 gf} max.
<b>RF min.</b>	2.75 N {280 gf}
<b>PT max.</b>	1.3 mm
<b>OT min.</b>	3.58 mm
<b>MD max.</b>	0.35 mm
<b>OP</b>	33.4 ± 1.2 mm

- Note:** 1. Do not use both M12 mounting screw and mounting holes at the same time.  
 2. Imperfect screw part with a maximum length of 1.5 mm.

### Short Hinge Lever

A-20GV21-B

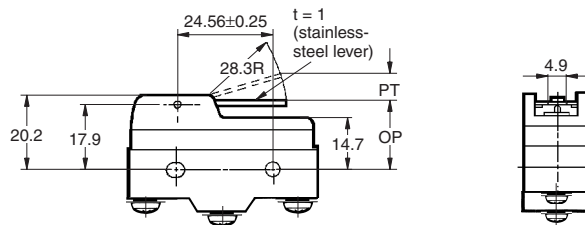
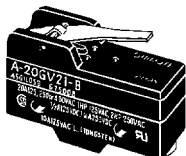

<b>OF</b>	1.57 N {160 gf} max.
<b>RF min.</b>	0.41 N {42 gf}
<b>PT max.</b>	6.5 mm
<b>OT min.</b>	1.2 mm
<b>MD max.</b>	1.2 mm
<b>OP</b>	19 ± 0.8 mm

**Hinge Lever**

**A-20GV-B**

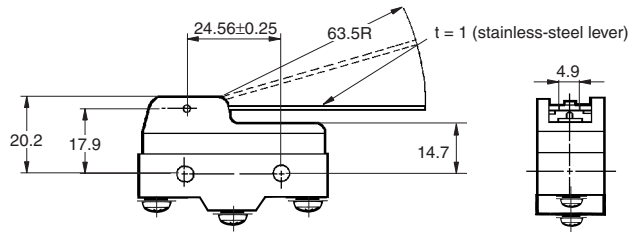
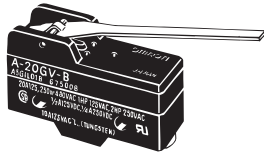

<b>OF</b>	0.69 N {70 gf} max.
<b>RF min.</b>	0.14 N {14 gf}
<b>PT max.</b>	15.9 mm
<b>OT min.</b>	4 mm
<b>MD max.</b>	2.4 mm
<b>OP</b>	19±0.8 mm

**Short Hinge Roller Lever**

**A-20GV22-B**

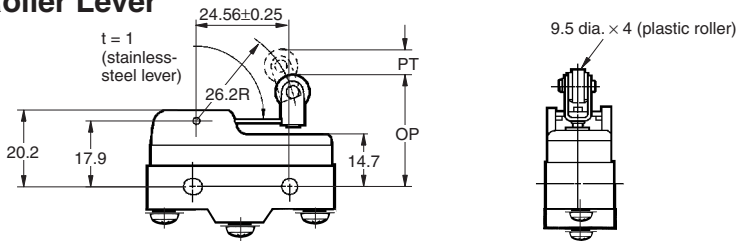
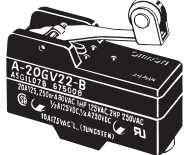

<b>OF</b>	1.57 N {160 gf}
<b>RF min.</b>	0.41 N {42 gf}
<b>PT max.</b>	6.3 mm
<b>OT min.</b>	1.2 mm
<b>MD max.</b>	1.22 mm
<b>OP</b>	29.8±0.8 mm

**Hinge Roller Lever**

**A-20GV2-B**

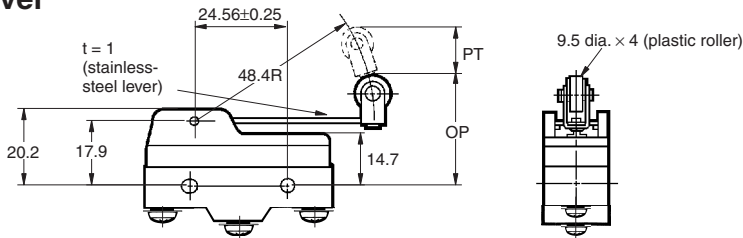
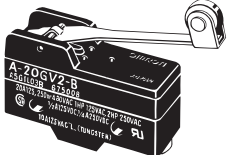

<b>OF</b>	0.88 N {90 gf}
<b>RF min.</b>	0.14 N {14 gf}
<b>PT max.</b>	12 mm
<b>OT min.</b>	2.4 mm
<b>MD max.</b>	2.2 mm
<b>OP</b>	30.2±0.8 mm

**■ Terminals**

**Screw Terminals (-B)**

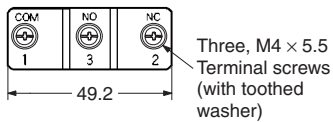
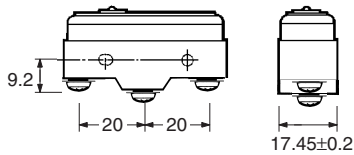

Appropriate terminal screw tightening torque: 0.78 to 1.18 N·m {8 to 12 kgf·cm}.

**Solder Terminal**

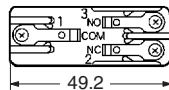
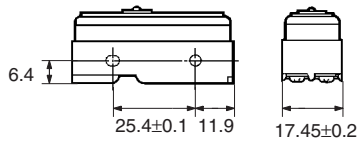

# Precautions

Refer to the *Technical Information for Basic Switches* (Cat. No. C122) for common precautions.

## ■ Correct Use

### Mounting

Use M4 mounting screws with plane washers or spring washers to securely mount the Switch. Tighten the screws to a torque of 1.18 to 1.47 N·m {12 to 15 kgf·cm}.

The Switch can be panel mounted, provided that the hexagonal nut of the actuator is tightened to a torque of 2.94 to 4.9 N·m {30 to 50 kgf·cm}.

### Mounting Holes

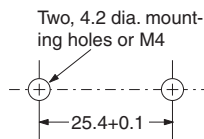

Panel Mount Plunger

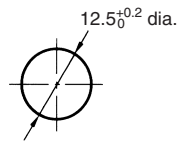

Panel Mount Roller Plunger

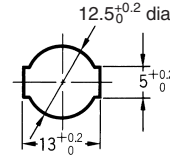

### Panel-mounting (A-20GQ□)

If a Switch is side-mounted with screws, remove the hexagonal nut of the actuator.

If a Switch is side-mounted and secured with screws, make sure that the angle or speed of the actuating object is not excessively large or too high, otherwise the Switch may be damaged.

If a Switch is panel-mounted, pay utmost attention to make sure that the actuating speed or OT distance is not excessively high or large. Not doing so may damage the Switch.

## ■ Accessories (Order Separately)

Refer to *Z/A/X/DZ Common Accessories* for details about Terminal Covers, Separators, and Actuators.

ALL DIMENSIONS SHOWN ARE IN MILLIMETERS.

To convert millimeters into inches, multiply by 0.03937. To convert grams into ounces, multiply by 0.03527.

Cat. No. B002-E1-07

In the interest of product improvement, specifications are subject to change without notice.