

High Efficiency Infrared 850nm LED Emitter

LZ1-00R402

Key Features

- Infrared 850nm LED emitter
- 53% Wall Plug Efficiency
- Ultra-small foot print – 4.4mm x 4.4mm
- Up to 1.2A drive current
- Surface mount ceramic package with integrated glass lens
- Low Thermal Resistance (6.0°C/W)
- Electrically neutral thermal path
- JEDEC Level 1 for Moisture Sensitivity Level
- Lead (Pb) free and RoHS compliant
- Reflow solderable
- Available on tape and reel or with MCPCB

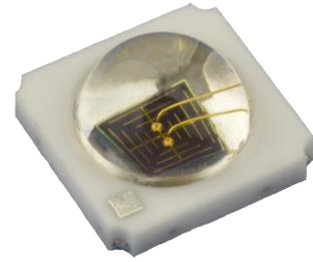

Typical Applications

- Surveillance cameras
- Traffic management
- Gesture recognition
- Machine vision
- Biometric sensing

Description

The LZ1-00R402 Infrared 850nm LED emitter generates 800mW nominal flux at 1.8W power dissipation in an extremely small package. With a 4.4mm x 4.4mm footprint, this package provides exceptional radiant flux density. The patent-pending design has unparalleled thermal and optical performance. The high quality materials used in the package are chosen to optimize optical performance and minimize stresses which results in monumental reliability and flux maintenance. The robust product design thrives in outdoor applications with high ambient temperatures and high humidity.

Notes

This product emits non visible infrared light, which can be hazardous depending on total system configuration (including, but not limited to optics, drive current and temperature). Observe safety precaution given in IEC 62471 when operating this product.

Part number options

Base part number

Part number	Description
LZ1-00R402-xxxx	LZ1 emitter
LZ1-10R402-xxxx	LZ1 emitter on Standard Star MCPCB

Bin kit option codes

R4, Infrared (850nm)			
Kit number suffix	Min flux Bin	Color Bin Range	Description
0000	K	F08 – F08	Flux bin K and above; full distribution wavelength

Radiant Flux Bins

Table 1:

Bin Code	Minimum Radiant Flux (Φ) @ $I_F = 1000\text{mA}$ ^[1] (mW)	Maximum Radiant Flux (Φ) @ $I_F = 1000\text{mA}$ ^[1] (mW)
K	640	800
L	800	1000

Notes for Table 1:

1. Radiant flux performance is measured at 10ms pulse, $T_C = 25^\circ\text{C}$. LED Engin maintains a tolerance of $\pm 10\%$ on flux measurements.

Peak Wavelength Bin

Table 2:

Bin Code	Minimum Peak Wavelength (λ_p) @ $I_F = 1000\text{mA}$ ^[1] (nm)	Maximum Peak Wavelength (λ_p) @ $I_F = 1000\text{mA}$ ^[1] (nm)
F08	835	875

Notes for Table 3:

1. Peak wavelength is measured at 10ms pulse, $T_C = 25^\circ\text{C}$. LED Engin maintains a tolerance of $\pm 2.0\text{nm}$ on peak wavelength measurements.

Forward Voltage Bin

Table 3:

Bin Code	Minimum Forward Voltage (V_F) @ $I_F = 1000\text{mA}$ ^[1] (V)	Maximum Forward Voltage (V_F) @ $I_F = 1000\text{mA}$ ^[1] (V)
0	1.3	2.3

Notes for Table 3:

1. Forward voltage is measured at 10ms pulse, $T_C = 25^\circ\text{C}$. LED Engin maintains a tolerance of $\pm 0.04\text{V}$ for forward voltage measurements.

Absolute Maximum Ratings

Table 4:

Parameter	Symbol	Value	Unit
DC Forward Current at $T_{J(MAX)}=100^{\circ}C$ ^[1]	I_F	1200	mA
DC Forward Current at $T_{J(MAX)}=125^{\circ}C$ ^[1]	I_F	1000	mA
Peak Pulsed Forward Current ^[2]	I_{FP}	2000	mA
Reverse Voltage	V_R	See Note 3	V
Storage Temperature	T_{stg}	-40 ~ +125	$^{\circ}C$
Junction Temperature	T_J	125	$^{\circ}C$
Soldering Temperature ^[4]	T_{sol}	260	$^{\circ}C$

Notes for Table 4:

1. Maximum DC forward current is determined by the overall thermal resistance and ambient temperature. Follow the curves in Figure 11 for current derating.
2. Pulse forward current conditions: Pulse Width \leq 10msec and Duty Cycle \leq 10%.
3. LEDs are not designed to be reverse biased.
4. Solder conditions per JEDEC 020D. See Reflow Soldering Profile Figure 3.
5. LED Engin recommends taking reasonable precautions towards possible ESD damages and handling the LZ1-00R402 in an electrostatic protected area (EPA). An EPA may be adequately protected by ESD controls as outlined in ANSI/ESD S6.1.

Optical Characteristics @ $T_C = 25^{\circ}C$

Table 5:

Parameter	Symbol	Typical	Unit
Radiant Flux (@ $I_F = 1000mA$)	Φ	800	mW
Radiant Flux (@ $I_F = 1200mA$)	Φ	950	mW
Wall Plug Efficiency (@ $I_F = 350mA$)	η	53	%
Wall Plug Efficiency (@ $I_F = 1000mA$)	η	42	%
Peak Wavelength	λ_p	850	nm
Viewing Angle ^[1]	$2\theta_{1/2}$	100	Degrees
Total Included Angle ^[2]	$\theta_{0.9V}$	120	Degrees

Notes for Table 5:

1. Viewing Angle is the off axis angle from emitter centerline where the radiant power is $\frac{1}{2}$ of the peak value.
2. Total Included Angle is the total angle that includes 90% of the total radiant flux.

Electrical Characteristics @ $T_C = 25^{\circ}C$

Table 6:

Parameter	Symbol	Typical	Unit
Forward Voltage (@ $I_F = 1000mA$)	V_F	1.8	V
Forward Voltage (@ $I_F = 1200mA$)	V_F	1.9	V
Temperature Coefficient of Forward Voltage	$\Delta V_F / \Delta T_J$	-2.0	mV/ $^{\circ}C$
Thermal Resistance (Junction to Case)	$R\theta_{J-C}$	6.0	$^{\circ}C/W$

IPC/JEDEC Moisture Sensitivity Level

Table 7 - IPC/JEDEC J-STD-020 MSL Classification:

Level	Floor Life		Soak Requirements			
	Time	Conditions	Standard	Accelerated	Time (hrs)	Conditions
1	1 Year	≤ 30°C/ 60% RH	168 +5/-0	85°C/ 60% RH	n/a	n/a

Notes for Table 7:

- The standard soak time is the sum of the default value of 24 hours for the semiconductor manufacturer's exposure time (MET) between bake and bag and the floor life of maximum time allowed out of the bag at the end user of distributor's facility.

Average Radiant Flux Maintenance Projections

Based on long-term WHTOL testing, LED Engin projects that the LZ Series will deliver, on average, above 70% Radiant Flux Maintenance at 50,000 hours of operation at a forward current of 1000 mA. This projection is based on constant current operation with junction temperature maintained at or below 110°C.

Recommended Solder Mask Layout (mm)

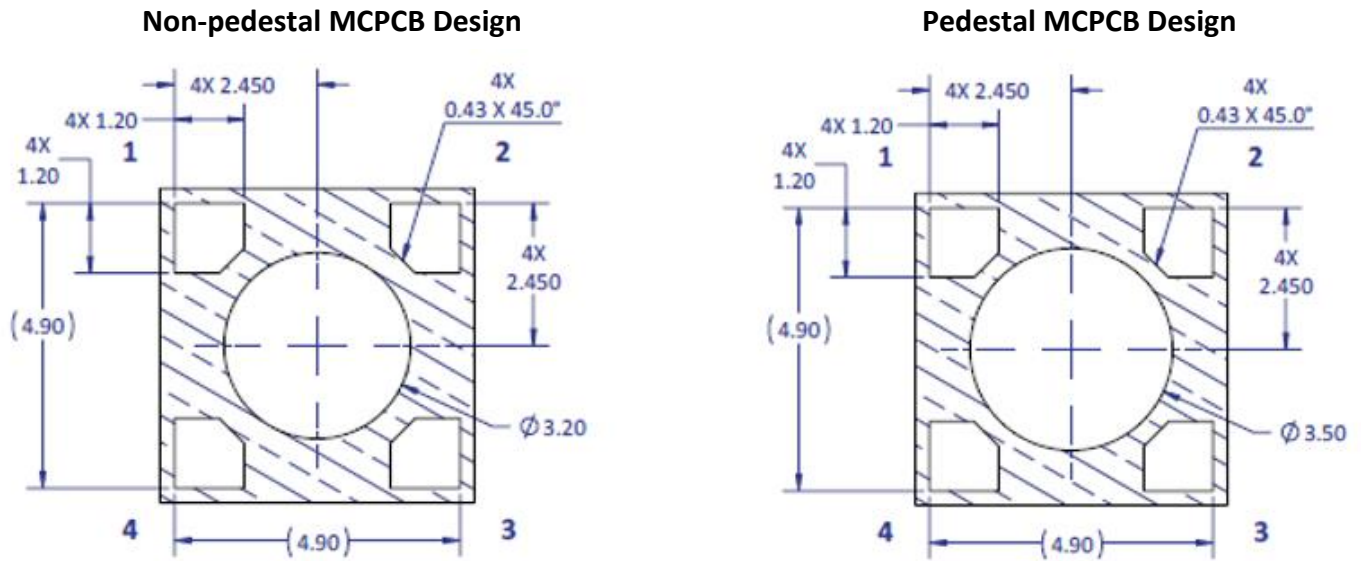

Figure 2b: Recommended solder mask opening for anode, cathode, and thermal pad for non-pedestal and pedestal design

Note for Figure 2b:

1. Unless otherwise noted, the tolerance = ± 0.20 mm.

Recommended 8mil Stencil Apertures Layout (mm)

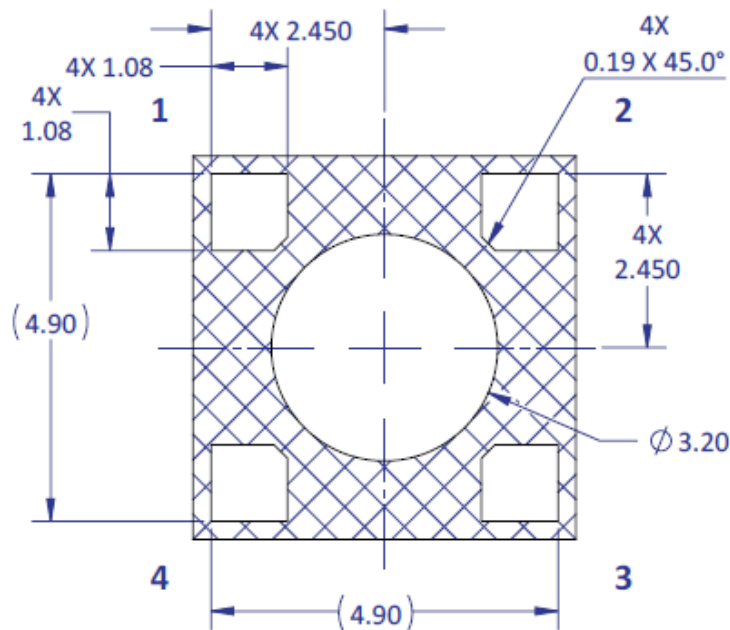

Figure 2c: Recommended solder mask opening for anode, cathode, and thermal pad for non-pedestal and pedestal design

Note for Figure 2c:

1. Unless otherwise noted, the tolerance = ± 0.20 mm.

Reflow Soldering Profile

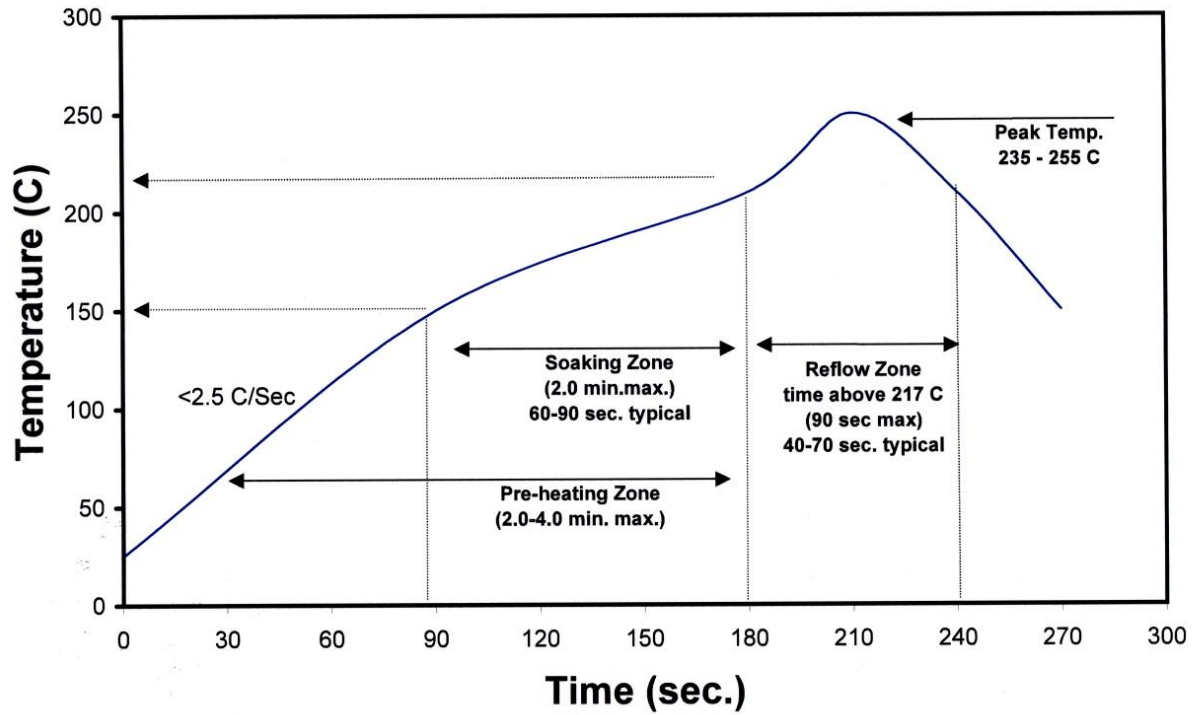

Figure 3: Reflow soldering profile for lead free soldering.

Typical Radiation Pattern

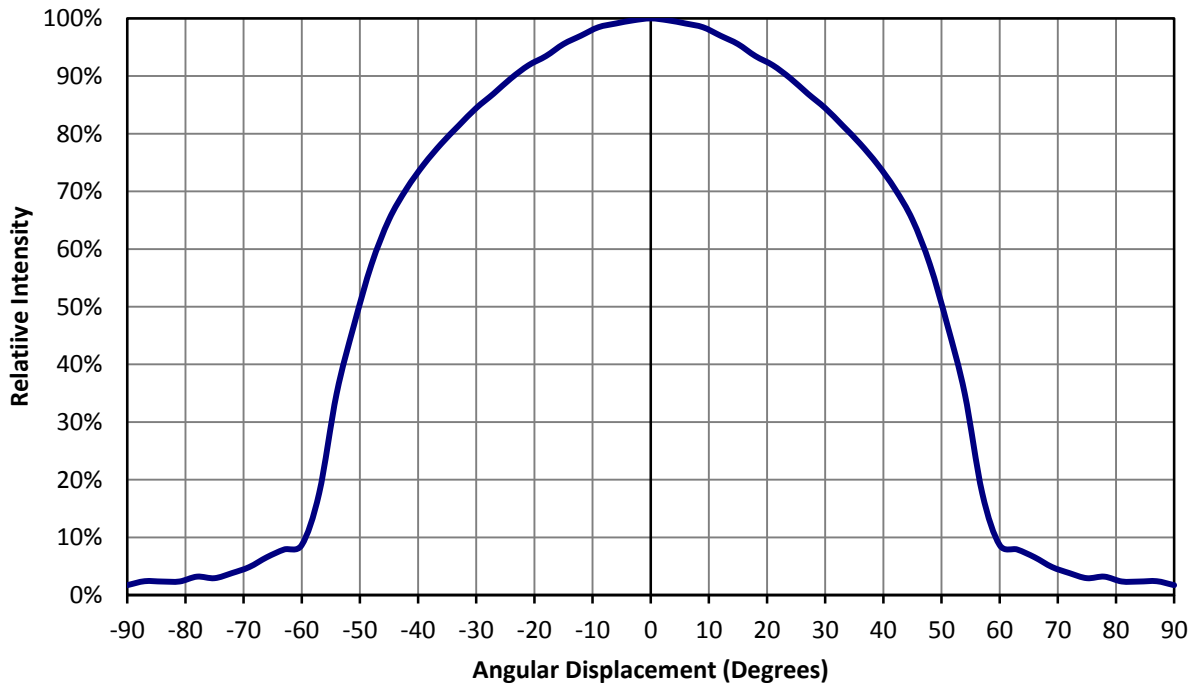

Figure 4: Typical representative spatial radiation pattern.

Typical Relative Spectral Power Distribution

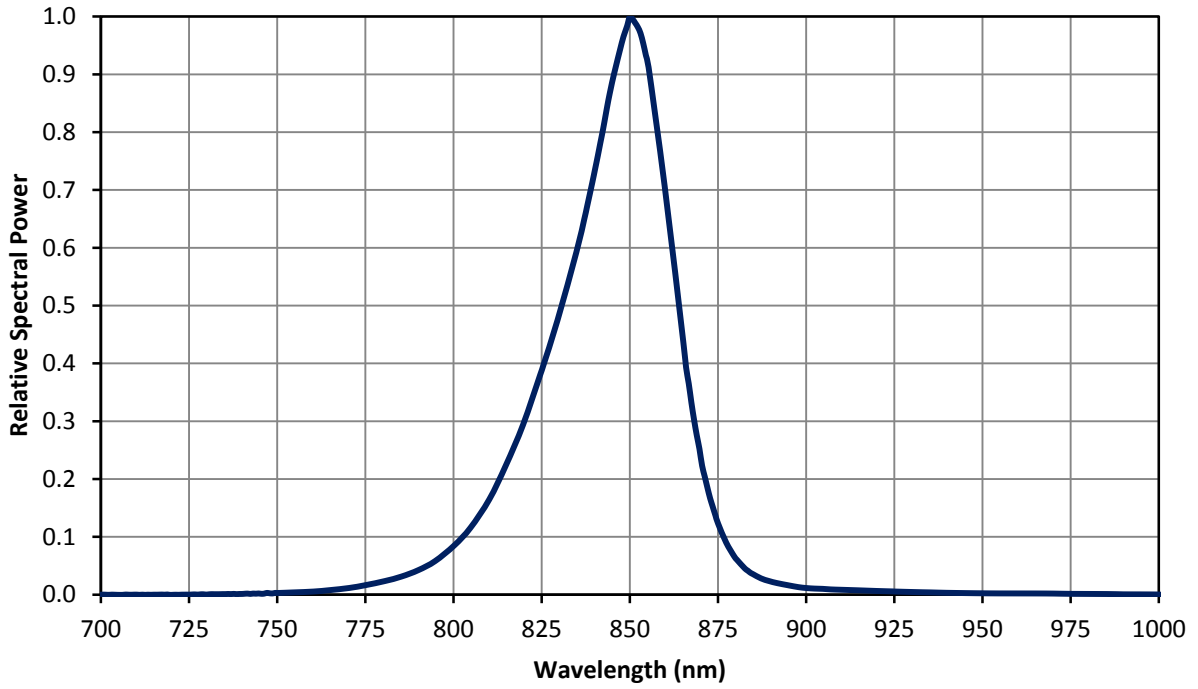

Figure 5: Relative spectral power vs. wavelength @ T_c = 25°C.

Typical Forward Current Characteristics

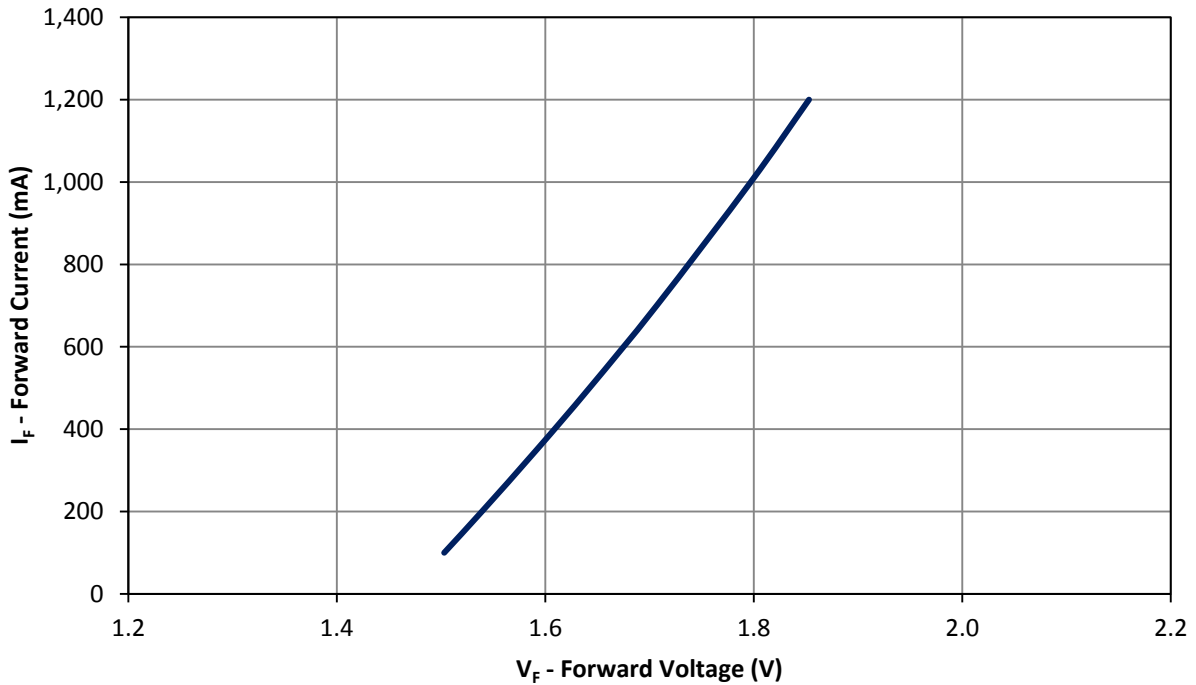

Figure 6: Typical forward current vs. forward voltage @ T_c = 25°C.

Typical Normalized Radiant Flux over Current

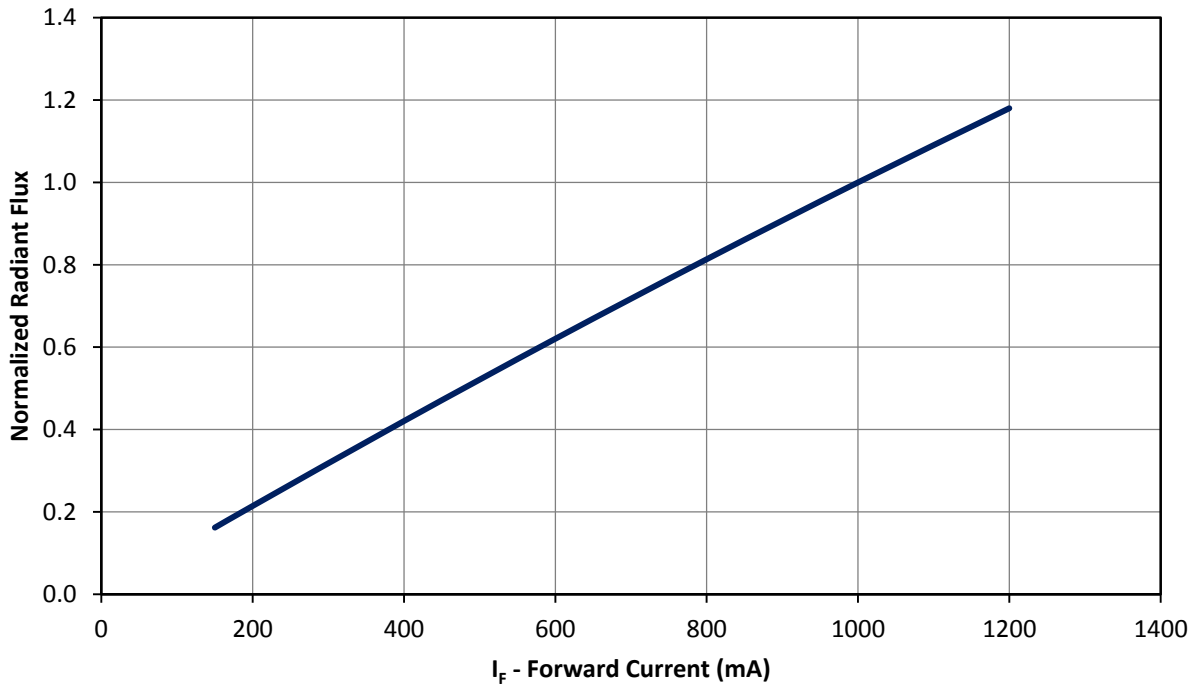

Figure 7: Typical normalized radiant flux vs. forward current @ $T_c = 25^\circ\text{C}$.

Typical Normalized Radiant Flux over Temperature

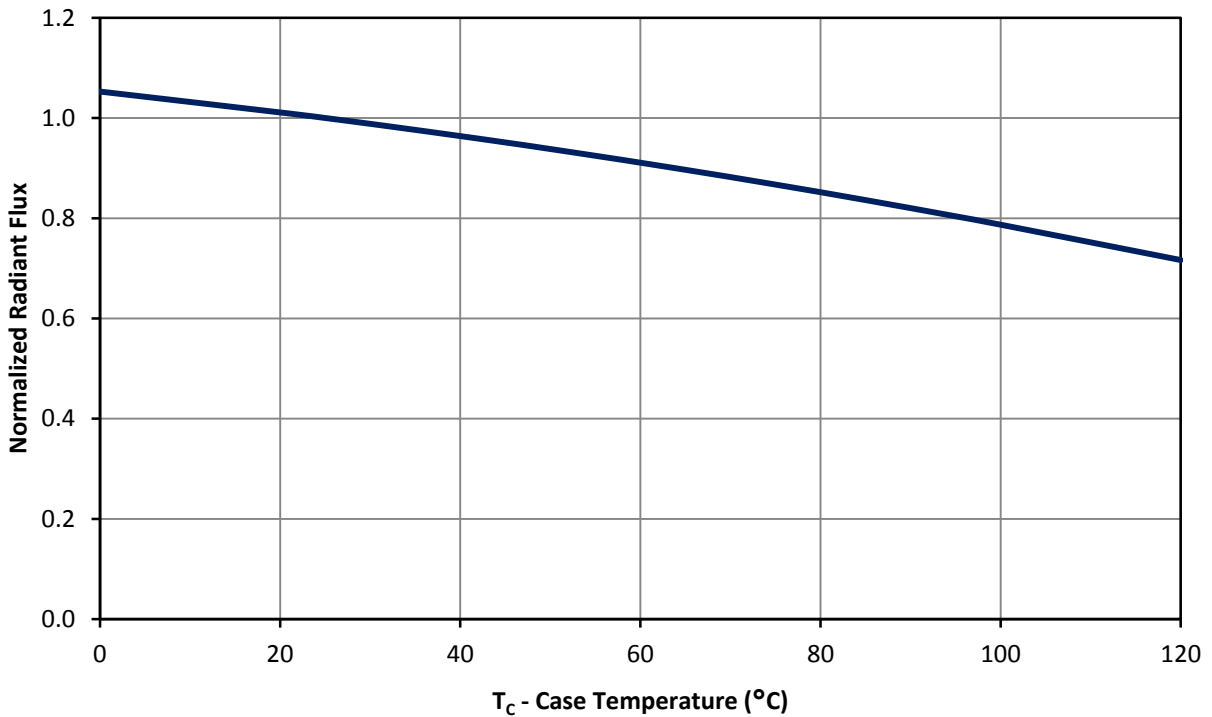

Figure 8: Typical normalized radiant flux vs. case temperature.

Typical Peak Wavelength Shift over Current

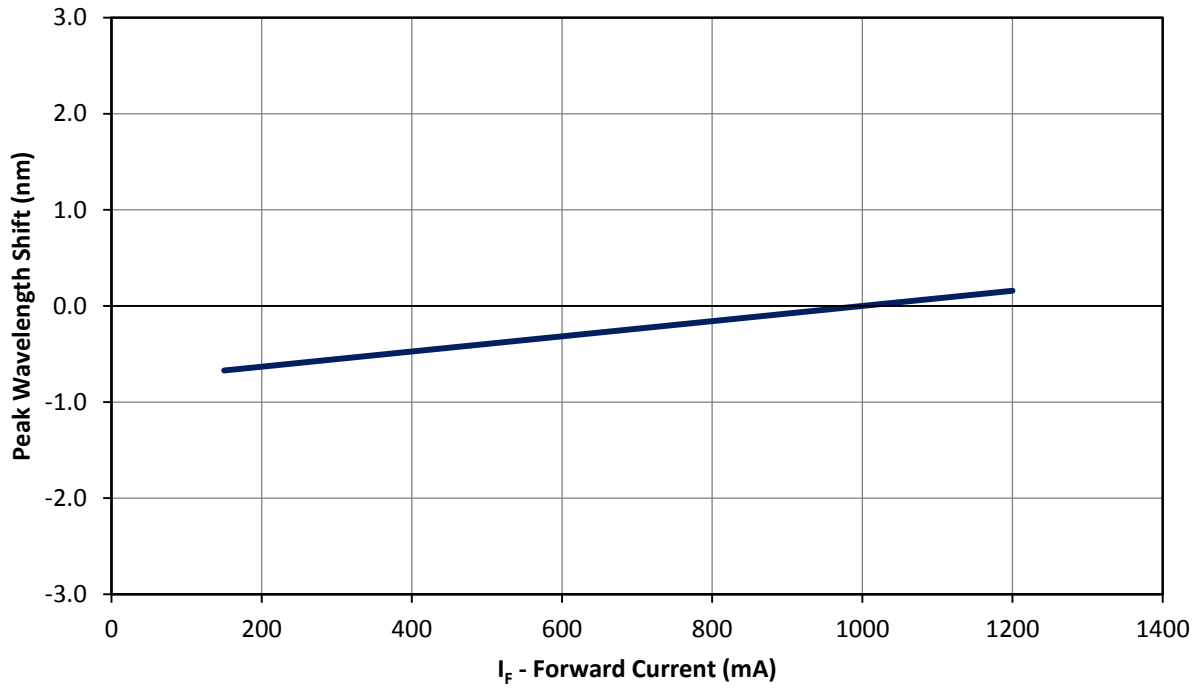

Figure 9: Typical peak wavelength shift vs. forward current @ $T_c = 25^\circ\text{C}$.

Typical Peak Wavelength Shift over Temperature

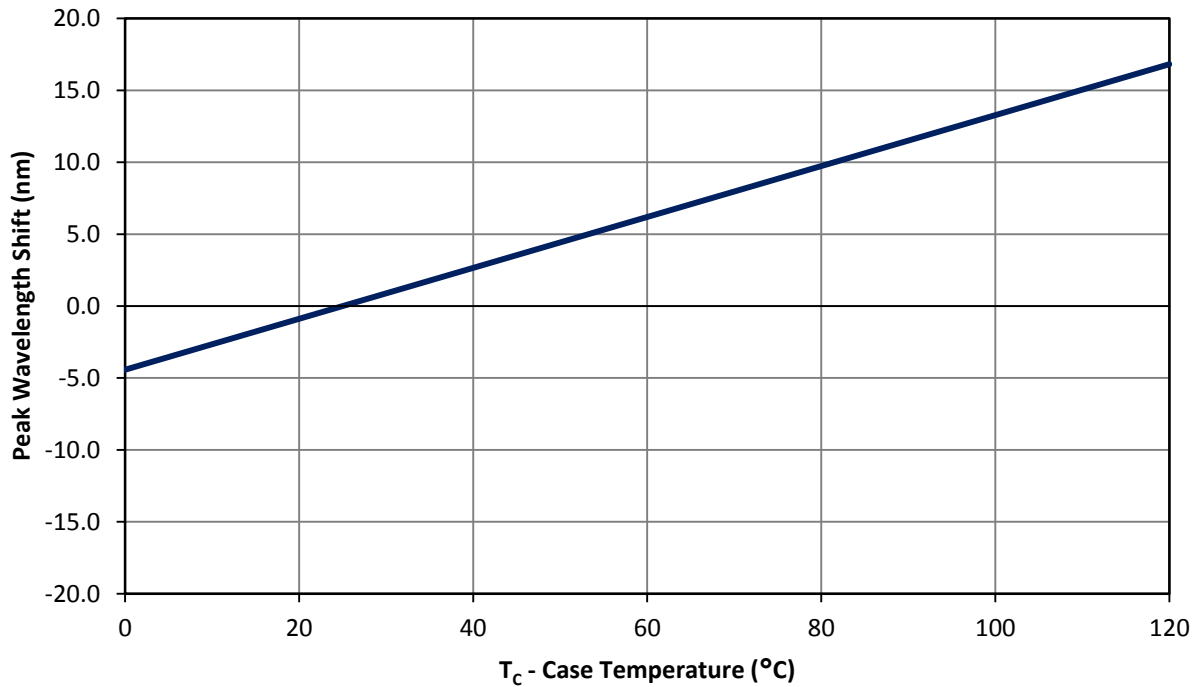

Figure 10: Typical peak wavelength shift vs. case temperature.

Current De-rating

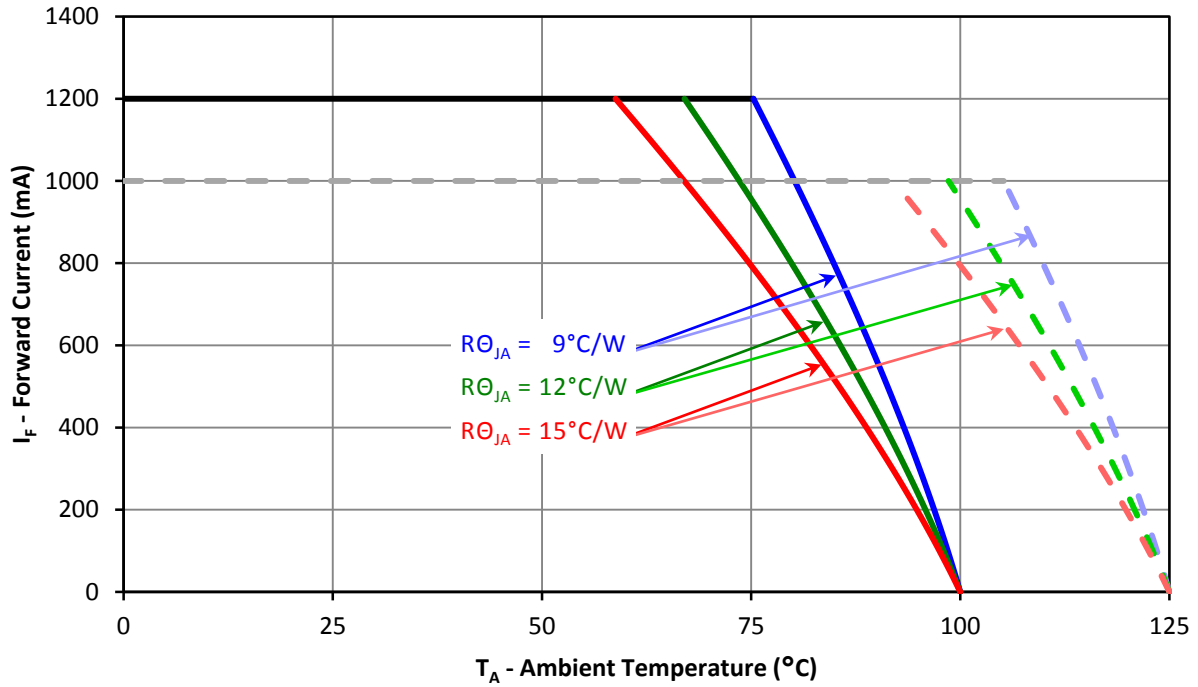

Figure 11: Maximum forward current vs. ambient temperature

Notes for Figure 11:

1. $R\theta_{j,c}$ [Junction to Case Thermal Resistance] for the LZ1-00R402 is typically 6°C/W .
2. $R\theta_{j,a}$ [Junction to Ambient Thermal Resistance] = $R\theta_{j,c}$ + $R\theta_{c,a}$ [Case to Ambient Thermal Resistance].

Emitter Tape and Reel Specifications (mm)



Figure 12: Emitter carrier tape specifications (mm).

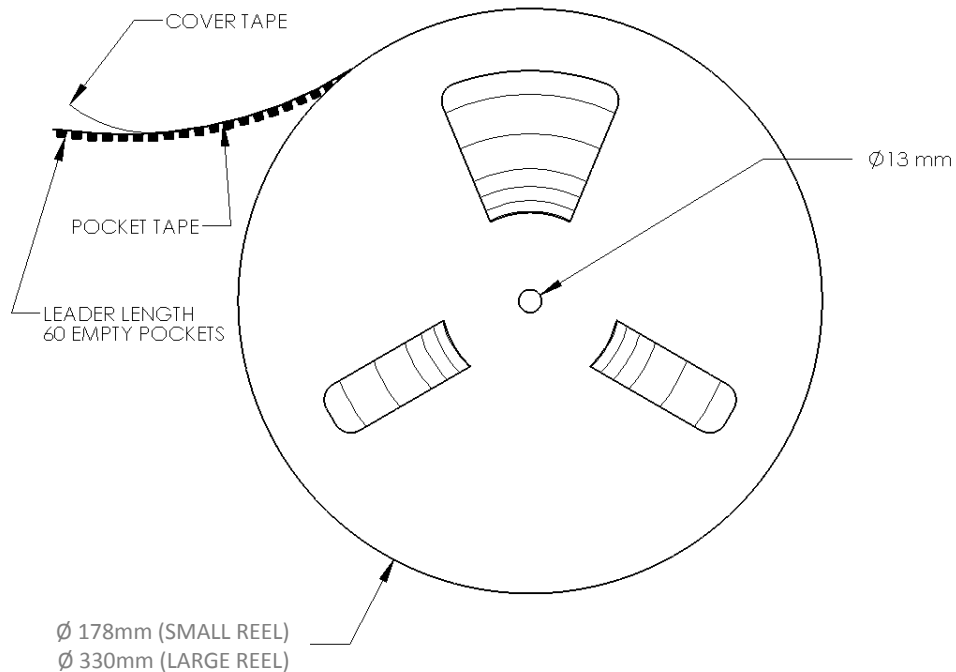

Figure 13: Emitter reel specifications (mm).

Notes:

1. Small reel quantity: up to 500 emitters
2. Large reel quantity: 501-2500 emitters.
3. Single flux bin and single wavelength bin per reel.

LZ1 MCPCB Family

Part number	Type of MCPCB	Diameter (mm)	Emitter + MCPCB Thermal Resistance (°C/W)	Typical V _F (V)	Typical I _F (mA)
LZ1-1xxxxx	1-channel Star	19.9	6.0 + 1.5 = 7.5	1.8	1000

Mechanical Mounting of MCPCB

- MCPCB bending should be avoided as it will cause mechanical stress on the emitter, which could lead to substrate cracking and subsequently LED dies cracking.
- To avoid MCPCB bending:
 - Special attention needs to be paid to the flatness of the heat sink surface and the torque on the screws.
 - Care must be taken when securing the board to the heat sink. This can be done by tightening three M3 screws (or #4-40) in steps and not all the way through at once. Using fewer than three screws will increase the likelihood of board bending.
 - It is recommended to always use plastics washers in combinations with the three screws.
 - If non-taped holes are used with self-tapping screws, it is advised to back out the screws slightly after tightening (with controlled torque) and then re-tighten the screws again.

Thermal interface material

- To properly transfer heat from LED emitter to heat sink, a thermally conductive material is required when mounting the MCPCB on to the heat sink.
- There are several varieties of such material: thermal paste, thermal pads, phase change materials and thermal epoxies. An example of such material is Electrolube EHTC.
- It is critical to verify the material's thermal resistance to be sufficient for the selected emitter and its operating conditions.
- It is recommended to verify thermal design by measuring case temperature (T_c) during design phase.

Wire soldering

- To ease soldering wire to MCPCB process, it is advised to preheat the MCPCB on a hot plate of 125-150°C. Subsequently, apply the solder and additional heat from the solder iron will initiate a good solder reflow. It is recommended to use a solder iron of more than 60W.
- It is advised to use lead-free, no-clean solder. For example: SN-96.5 AG-3.0 CU 0.5 #58/275 from Kester (pn: 24-7068-7601)

LZ1-1xxxxx

1 channel, Standard Star MCPCB (1x1) Dimensions (mm)

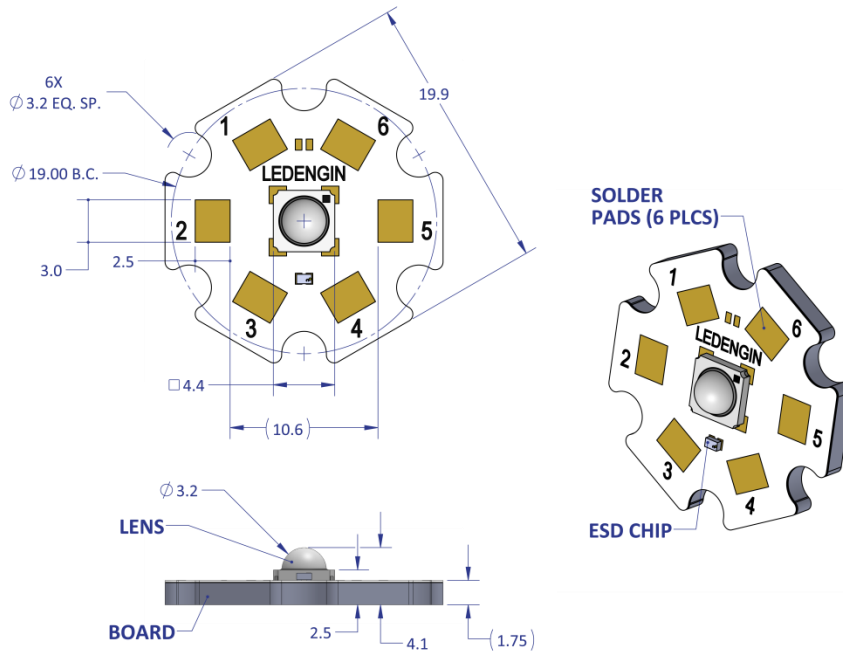

Notes:

- Unless otherwise noted, the tolerance = ± 0.2 mm.
- Slots in MCPCB are for M3 or #4-40 mounting screws.
- LED Engin recommends plastic washers to electrically insulate screws from solder pads and electrical traces.
- LED Engin recommends using thermal interface material when attaching the MCPCB to a heat sink.
- The thermal resistance of the MCPCB is: $R_{\theta_{c-b}} 1.5^{\circ}\text{C/W}$.

Components used

MCPCB:	HT04503	(Bergquist)
ESD/TVS diode:	BZT52C5V1LP-7	(Diodes, Inc., for 1 LED die)
	VBUS05L1-DD1	(Vishay Semiconductors, for 1 LED die)

Pad layout			
Ch.	MCPCB Pad	String/die	Function
1	1,2,3	1/A	Cathode -
	4,5,6		Anode +

Company Information

LED Engin, Inc., based in California's Silicon Valley, specializes in ultra-bright, ultra compact solid state lighting solutions allowing lighting designers & engineers the freedom to create uncompromised yet energy efficient lighting experiences. The LuxiGen™ Platform — an emitter and lens combination or integrated module solution, delivers superior flexibility in light output, ranging from 3W to 90W, a wide spectrum of available colors, including whites, multi-color and UV, and the ability to deliver upwards of 5,000 high quality lumens to a target. The small size combined with powerful output allows for a previously unobtainable freedom of design wherever high-flux density, directional light is required. LED Engin's packaging technologies lead the industry with products that feature lowest thermal resistance, highest flux density and consummate reliability, enabling compact and efficient solid state lighting solutions.

LED Engin is committed to providing products that conserve natural resources and reduce greenhouse emissions.

LED Engin reserves the right to make changes to improve performance without notice.

Please contact sales@ledengin.com or (408) 922-7200 for more information.