

Datasheet

Anti Surge T LBC Fuse, 5A, 5x20mm

RS Stock number [668-6010](#)

GSL

GST-A



Specifications:

Operating Temperature

-55°C to +125°C

Materials

Glass body / Nickel Plated Brass Caps

Lead Wire:

Diameter Ø0.8 mm 14A and less.

Diameter Ø1.0 mm for rating above 15A to 19A.

Diameter Ø1.2 mm for rating above 20A.

Interrupting Ratings

10mA~8A: 10,000 amperes at 125V AC

10mA~1A: 35 amperes at 250V AC

1.5A~3.5A: 100 amperes at 250V AC

3.75A~8A: 200 amperes at 250V AC

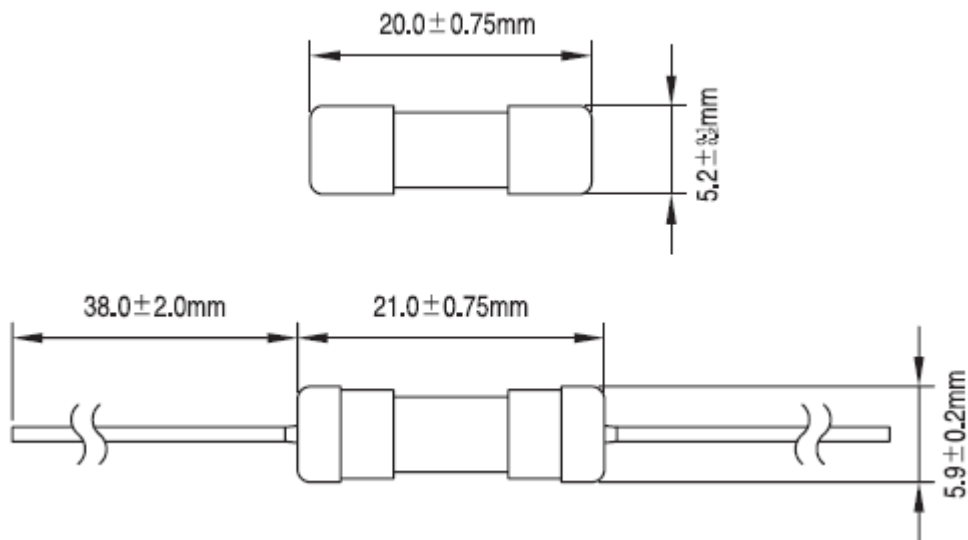
Drawing (mm):

Electrical Characteristic:

Rated Current	1 In	1.35In	2 In	
	MIN	MAX	MIN	MAX
10mA~20A	4 hr	1 hr	3 sec	120 sec