

Key-operated switch BKS, 22 mm, round, plastic with metal front ring, lock number S1, with 2 keys, 3 switch positions I-O-II, latching, actuating angle 2x45°, 10:30h/12h/13:30h, Key removal O



| | |
|--------------------------|-----------------------------|
| Product brand name | SIRIUS ACT |
| Product designation | Key-operated switches |
| Design of the product | Actuating/signaling element |
| Product type designation | 3SU1 |

| Actuator | |
|---|--|
| Manner of function of the actuating element | latching, 2x45° (10:30 h/12 h/13:30 h) |
| Product extension optional Light source | No |
| Color | |
| • of the actuating element | silver |
| Material of the actuating element | metal |
| Shape of the actuating element | Key |
| Outer diameter of the actuating element | 29.5 mm |
| Number of switching positions | 3 |
| Switch position for key distraction | O |
| Actuating angle | |
| • clockwise | 45° |
| • anticlockwise | 45° |
| Lock make | BCS |
| Key number | S1 |





| Front ring | |
|------------------------------|-------------|
| Product component front ring | Yes |
| Design of the front ring | Standard |
| Material of the front ring | Metal, matt |
| Color of the front ring | sand gray |

| General technical data | |
|---|--|
| Protection class IP | IP66, IP67, IP69(IP69K) |
| <ul style="list-style-type: none"> of the terminal | IP20 |
| Degree of protection NEMA rating | NEMA 1, 2, 3, 3R, 4, 4X, 12, 13 |
| Shock resistance | |
| <ul style="list-style-type: none"> acc. to IEC 60068-2-27 for railway applications acc. to DIN EN 61373 | Sinusoidal half-wave 50 g / 11 ms Category 1, Class B |
| Operating frequency maximum | 1 800 1/h |
| Mechanical service life (switching cycles) | |
| <ul style="list-style-type: none"> typical | 1 000 000 |
| Reference code acc. to DIN EN 81346-2 | S |
| Reference code acc. to DIN EN 61346-2 | S |

| Ambient conditions | |
|--|---|
| Ambient temperature | |
| <ul style="list-style-type: none"> during operation during storage | -25 ... +70 °C -40 ... +80 °C |
| Environmental category during operation acc. to IEC 60721 | 3M6, 3S2, 3B2, 3C3, 3K6 (with relative air humidity of 10 ... 95 %) |

| Installation/ mounting/ dimensions | |
|---|---------|
| Height | 29.5 mm |
| Width | 29.5 mm |
| Shape of the installation opening | round |
| Mounting diameter | 22.3 mm |
| Positive tolerance of installation diameter | 0.4 mm |
| Mounting height | 56.3 mm |
| Installation width | 29.5 mm |
| Installation depth | 25.4 mm |

Certificates/approvals

| | | | | | |
|--|---|---|---|-------------------------------|--|
| General Product Approval | | | Declaration of Conformity | | Test Certificates |
|  CSA |  UL |  |  EG-Konf. | Miscellaneous | Special Test Certificate |

| | | | | | |
|--|--|--|--|---|---|
| Test Certificates | Marine / Shipping | | | | |
| Type Test Certificates/Test Report |  ABS |  LRS |  PRS |  RINA |  RMRS |

| | |
|---|------------------------------|
| Marine / Shipping | other |
|  | Confirmation |

Further information

Information- and Downloadcenter (Catalogs, Brochures,...)

<http://www.siemens.com/industrial-controls/catalogs>

Industry Mall (Online ordering system)

<https://mall.industry.siemens.com/mall/en/en/Catalog/product?mlfb=3SU1030-5PL01-0AA0>

Cax online generator

<http://support.automation.siemens.com/WW/CAXorder/default.aspx?lang=en&mlfb=3SU1030-5PL01-0AA0>

Service&Support (Manuals, Certificates, Characteristics, FAQs,...)

<https://support.industry.siemens.com/cs/ww/en/ps/3SU1030-5PL01-0AA0>

Image database (product images, 2D dimension drawings, 3D models, device circuit diagrams, EPLAN macros, ...)

http://www.automation.siemens.com/bilddb/cax_de.aspx?mlfb=3SU1030-5PL01-0AA0&lang=en

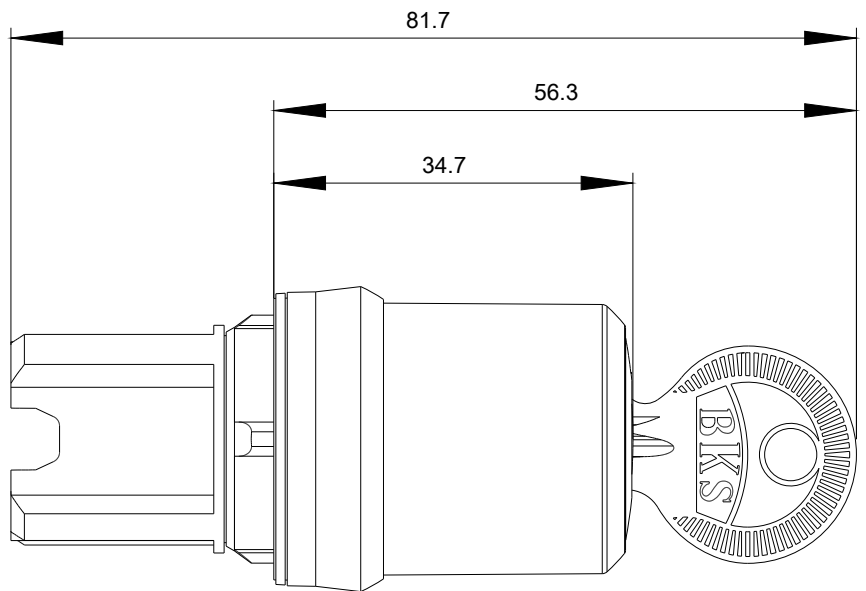
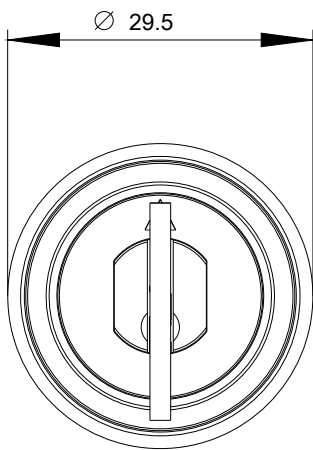

last modified:

09/12/2019