



MICROCHIP

CL88030
230 V_{AC} Offline LED Driver
Evaluation Board
User's Guide

Note the following details of the code protection feature on Microchip devices:

- Microchip products meet the specification contained in their particular Microchip Data Sheet.
- Microchip believes that its family of products is one of the most secure families of its kind on the market today, when used in the intended manner and under normal conditions.
- There are dishonest and possibly illegal methods used to breach the code protection feature. All of these methods, to our knowledge, require using the Microchip products in a manner outside the operating specifications contained in Microchip's Data Sheets. Most likely, the person doing so is engaged in theft of intellectual property.
- Microchip is willing to work with the customer who is concerned about the integrity of their code.
- Neither Microchip nor any other semiconductor manufacturer can guarantee the security of their code. Code protection does not mean that we are guaranteeing the product as "unbreakable."

Code protection is constantly evolving. We at Microchip are committed to continuously improving the code protection features of our products. Attempts to break Microchip's code protection feature may be a violation of the Digital Millennium Copyright Act. If such acts allow unauthorized access to your software or other copyrighted work, you may have a right to sue for relief under that Act.

Information contained in this publication regarding device applications and the like is provided only for your convenience and may be superseded by updates. It is your responsibility to ensure that your application meets with your specifications. MICROCHIP MAKES NO REPRESENTATIONS OR WARRANTIES OF ANY KIND WHETHER EXPRESS OR IMPLIED, WRITTEN OR ORAL, STATUTORY OR OTHERWISE, RELATED TO THE INFORMATION, INCLUDING BUT NOT LIMITED TO ITS CONDITION, QUALITY, PERFORMANCE, MERCHANTABILITY OR FITNESS FOR PURPOSE. Microchip disclaims all liability arising from this information and its use. Use of Microchip devices in life support and/or safety applications is entirely at the buyer's risk, and the buyer agrees to defend, indemnify and hold harmless Microchip from any and all damages, claims, suits, or expenses resulting from such use. No licenses are conveyed, implicitly or otherwise, under any Microchip intellectual property rights unless otherwise stated.

Microchip received ISO/TS-16949:2009 certification for its worldwide headquarters, design and wafer fabrication facilities in Chandler and Tempe, Arizona; Gresham, Oregon and design centers in California and India. The Company's quality system processes and procedures are for its PIC® MCUs and dsPIC® DSCs, KEELOQ® code hopping devices, Serial EEPROMs, microperipherals, nonvolatile memory and analog products. In addition, Microchip's quality system for the design and manufacture of development systems is ISO 9001:2000 certified.

**QUALITY MANAGEMENT SYSTEM
CERTIFIED BY DNV
= ISO/TS 16949 =**

Trademarks

The Microchip name and logo, the Microchip logo, AnyRate, AVR, AVR logo, AVR Freaks, BitCloud, chipKIT, chipKIT logo, CryptoMemory, CryptoRF, dsPIC, FlashFlex, flexPWR, Helder, JukeBlox, KeeLoq, Klear, LANCheck, LINK MD, maXStylus, maXTouch, MediaLB, megaAVR, MOST, MOST logo, MPLAB, OptoLyzer, PIC, picoPower, PICSTART, PIC32 logo, Prochip Designer, QTouch, SAM-BA, SpyNIC, SST, SST Logo, SuperFlash, tinyAVR, UNI/O, and XMEGA are registered trademarks of Microchip Technology Incorporated in the U.S.A. and other countries.

ClockWorks, The Embedded Control Solutions Company, EtherSynch, Hyper Speed Control, HyperLight Load, IntellIMOS, mTouch, Precision Edge, and Quiet-Wire are registered trademarks of Microchip Technology Incorporated in the U.S.A.

Adjacent Key Suppression, AKS, Analog-for-the-Digital Age, Any Capacitor, AnyIn, AnyOut, BodyCom, CodeGuard, CryptoAuthentication, CryptoAutomotive, CryptoCompanion, CryptoController, dsPICDEM, dsPICDEM.net, Dynamic Average Matching, DAM, ECAN, EtherGREEN, In-Circuit Serial Programming, ICSP, INICnet, Inter-Chip Connectivity, JitterBlocker, KlearNet, KlearNet logo, memBrain, Mindi, MiWi, motorBench, MPASM, MPF, MPLAB Certified logo, MPLIB, MPLINK, MultiTRAK, NetDetach, Omniscient Code Generation, PICDEM, PICDEM.net, PICkit, PICtail, PowerSmart, PureSilicon, QMatrix, REAL ICE, Ripple Blocker, SAM-ICE, Serial Quad I/O, SMART-I.S., SQI, SuperSwitcher, SuperSwitcher II, Total Endurance, TSHARC, USBCheck, VariSense, ViewSpan, WiperLock, Wireless DNA, and ZENA are trademarks of Microchip Technology Incorporated in the U.S.A. and other countries.

SQTP is a service mark of Microchip Technology Incorporated in the U.S.A.

Silicon Storage Technology is a registered trademark of Microchip Technology Inc. in other countries.

GestIC is a registered trademark of Microchip Technology Germany II GmbH & Co. KG, a subsidiary of Microchip Technology Inc., in other countries.

All other trademarks mentioned herein are property of their respective companies.

© 2018, Microchip Technology Incorporated, All Rights Reserved.
ISBN: 978-1-5224-3372-9

Table of Contents

Preface	5
Introduction.....	5
Document Layout	5
Conventions Used in this Guide	6
Recommended Reading.....	7
The Microchip Website	7
Customer Support	7
Document Revision History	7
 Chapter 1. Product Overview	
1.1 Introduction	9
1.2 CL88030 Overview	9
1.3 CL88030 Key Features	9
1.4 What is the CL88030 230 V _{AC} Offline LED Driver Evaluation Board (ADM00860)?	11
1.5 What the CL88030 230 V _{AC} Offline LED Driver Evaluation Board Kit Contains	13
 Chapter 2. Installation and Operation	
2.1 Introduction	15
2.2 Getting Started	16
2.3 Setup Procedure	17
2.4 How Does the CL88030 230 V _{AC} Offline LED Driver Evaluation Board Set Work?	18
2.5 Board Testing	19
 Appendix A. Schematic and Layouts	
A.1 Introduction	21
A.2 Board Schematic – ADM00860	22
A.3 Board Schematic – ADM00861	23
A.4 ADM00860 – Top Silk	23
A.5 ADM00860 – Top Copper and Silk	24
A.6 ADM00860 – Top Copper	24
A.7 ADM00860 – Bottom Copper and Silk	25
A.8 ADM00861 – Top Silk	25
A.9 AMD00861 – Top Copper and Silk	26
A.10 ADM00861 – Top Copper	26
A.11 ADM00861 – Bottom Copper and Silk	27
 Appendix B. Bill of Materials (BOM)	29

Appendix C. Plots and Waveforms

C.1 CL88030 230 V _{AC} Offline LED Driver Evaluation Board Typical Waveforms	31
C.2 CL88030 230 V _{AC} Offline LED Driver Evaluation Board Typical Measurements	37
Worldwide Sales and Service	41

Preface

NOTICE TO CUSTOMERS

All documentation becomes dated, and this manual is no exception. Microchip tools and documentation are constantly evolving to meet customer needs, so some actual dialogs and/or tool descriptions may differ from those in this document. Please refer to our website (www.microchip.com) to obtain the latest documentation available.

Documents are identified with a “DS” number. This number is located on the bottom of each page, in front of the page number. The numbering convention for the DS number is “DSXXXXXXXXA”, where “XXXXXXXX” is the document number and “A” is the revision level of the document.

For the most up-to-date information on development tools, see the MPLAB[®] IDE online help. Select the Help menu, and then Topics to open a list of available online help files.

INTRODUCTION

This chapter contains general information that will be useful to know before using the CL88030 230 V_{AC} Offline LED Driver Evaluation Board. Items discussed in this chapter include:

- [Document Layout](#)
- [Conventions Used in this Guide](#)
- [Recommended Reading](#)
- [The Microchip Website](#)
- [Customer Support](#)
- [Document Revision History](#)

DOCUMENT LAYOUT

This document describes how to use the CL88030 230 V_{AC} Offline LED Driver Evaluation Board as a development tool. The manual layout is as follows:

- **Chapter 1. “Product Overview”** – Important information about the CL88030 230 V_{AC} Offline LED Driver Evaluation Board.
- **Chapter 2. “Installation and Operation”** – Includes instructions on how to get started with the CL88030 230 V_{AC} Offline LED Driver Evaluation Board and a detailed description of each function.
- **Appendix A. “Schematic and Layouts”** – Shows the schematic and layout diagrams for the CL88030 230 V_{AC} Offline LED Driver Evaluation Board.
- **Appendix B. “Bill of Materials (BOM)”** – Lists the parts used to build the CL88030 230 V_{AC} Offline LED Driver Evaluation Board.
- **Appendix C. “Plots and Waveforms”** – Describes the plots and waveforms for the CL88030 230 V_{AC} Offline LED Driver Evaluation Board.

CONVENTIONS USED IN THIS GUIDE

This manual uses the following documentation conventions:

DOCUMENTATION CONVENTIONS

Description	Represents	Examples
Arial font:		
Italic characters	Referenced books	<i>MPLAB[®] IDE User's Guide</i>
	Emphasized text	...is the <i>only</i> compiler...
Initial caps	A window	the Output window
	A dialog	the Settings dialog
	A menu selection	select Enable Programmer
Quotes	A field name in a window or dialog	"Save project before build"
Underlined, italic text with right angle bracket	A menu path	<u><i>File>Save</i></u>
Bold characters	A dialog button	Click OK
	A tab	Click the Power tab
N'Rnnnn	A number in verilog format, where N is the total number of digits, R is the radix and n is a digit.	4'b0010, 2'hF1
Text in angle brackets < >	A key on the keyboard	Press <Enter>, <F1>
Courier New font:		
Plain Courier New	Sample source code	#define START
	Filenames	autoexec.bat
	File paths	c:\mcc18\h
	Keywords	_asm, _endasm, static
	Command-line options	-Opa+, -Opa-
	Bit values	0, 1
	Constants	0xFF, 'A'
Italic Courier New	A variable argument	<i>file.o</i> , where <i>file</i> can be any valid filename
Square brackets []	Optional arguments	mcc18 [options] <i>file</i> [options]
Curly brackets and pipe character: { }	Choice of mutually exclusive arguments; an OR selection	errorlevel {0 1}
Ellipses...	Replaces repeated text	var_name [, var_name...]
	Represents code supplied by user	void main (void) { ... }

RECOMMENDED READING

This user's guide describes how to use the CL88030 230 V_{AC} Offline LED Driver Evaluation Board. Another useful document is listed below. The following Microchip document is available and recommended as supplemental reference resource:

- **CL88030 Data Sheet - Sequential Linear LED Driver with Four or Six Taps (DS20006049)**

THE MICROCHIP WEBSITE

Microchip provides on-line support via our website at www.microchip.com. This website is used as a means to make files and information easily available to customers. Accessible by using your favorite internet browser, the website contains the following information:

- **Product Support** – Data sheets, errata, application notes, sample programs, design resources, user's guides, hardware support documents, latest software releases, and archived software
- **General Technical Support** – Frequently Asked Questions (FAQs), technical support requests, online discussion groups, Microchip consultant program member listing
- **Business of Microchip** – Product selector and ordering guides, latest Microchip press releases, listing of seminars and events, listings of Microchip sales offices, distributors and factory representatives

CUSTOMER SUPPORT

Users of Microchip products can receive assistance through several channels:

- Distributor or Representative
- Local Sales Office
- Field Application Engineer (FAE)
- Technical Support

Customers should contact their distributor, representative or Field Application Engineer (FAE) for support. Local sales offices are also available to help customers. A listing of sales offices and locations is included in the back of this document.

Technical support is available through the website at:
<http://www.microchip.com/support>.

DOCUMENT REVISION HISTORY

Revision A (August 2018)

- Initial release of this document.

CL88030 230 V_{AC} Offline LED Driver Evaluation Board User's Guide

NOTES:

Chapter 1. Product Overview

1.1 INTRODUCTION

This chapter provides an overview of the CL88030 230 V_{AC} Offline LED Driver Evaluation Board and covers the following topics:

- [CL88030 Overview](#)
- [CL88030 Key Features](#)
- [What is the CL88030 230 V_{AC} Offline LED Driver Evaluation Board \(ADM00860\)?](#)
- [What the CL88030 230 V_{AC} Offline LED Driver Evaluation Board Kit Contains](#)

1.2 CL88030 OVERVIEW

The CL88030 driver Integrated Circuit (IC) is a sequential linear LED driver, 4-tap version, targeted to provide a flexible solution to drive LEDs from AC line voltages up to 277 V_{AC} and at high-output powers.

A sequential linear LED driver is an LED driver, operating from an AC voltage source and comprised of multiple linear current regulators driving various tap points along a long string of LEDs connected to the rectified AC. High efficiency is achieved by shutting off upstream regulators when downstream regulators achieve regulation.

The CL88030 is in a DFN-10 package. The power dissipation for this device is much lower than the CL8800 or CL88020 one, due to the external FETs. The bottom tab is not necessary for thermal reasons, but it is necessary to provide 11 electrical connections for the CL88030.

1.3 CL88030 KEY FEATURES

- Scalable:
 - AC line voltage limited only by external FETs
 - Output power limited only by external FETs
- No Inductors:
 - Reduces BOM cost and circuit complexity
- Efficient Operation:
 - Typical electrical efficiencies of 80% to 90% across the AC input voltage range
- No High Frequencies:
 - Inherently low-conducted EMI, no need for input filters
- Inherently Dimmer Compatible:
 - Works with most leading-edge and trailing-edge phase-cut dimmers
 - Requires no special circuitry to detect and to handle dimmers
 - May require an RC network across the AC line to provide adequate TRIAC latching current
- Two Versions - 4-tap (CL88030) and 6-tap (CL88031):
 - Higher taps increase efficiency and lower Total Harmonic Distortion (THD)
 - Fewer taps reduce costs

- Reduced Output Ripple (optional):
 - An external capacitor with four diodes provides lower output ripple
 - Strobing occurs at low line
 - Provides continuous power to the driver
- Active Line Regulation:
 - Active circuitry provides better regulated output power over variations in AC line voltage
 - -12%/+0% line regulation typical
 - Prevents driver from overheating at high AC line voltages
 - Prevents excessive currents at low line
 - Required for reasonable line regulation and efficient operation, given only four or six taps
 - If unused, the ALR pin is left open in the application
- Overtemperature Protection (OTP), Optional:
 - An inexpensive external NTC thermistor provides remote temperature sensing. The thermistor may be near the LEDs to provide nearly direct monitoring of LED temperature.
 - OTP is linear (no on/off cycling)
 - A widely available, 470 k Ω NTC provides an 85°C maximum temperature
 - Temperature adjustable via selection of NTC thermistor resistance
 - If unused, the OTP pin is tied to BIAS
- Two Current-setting Resistors:
 - Different hold-up and direct AC currents lower the THD and output ripple
 - Tap current ratios internally set
 - Reduces component count
 - Fewer pins
 - Simplifies application design
 - Single-point current control for reduced EMI

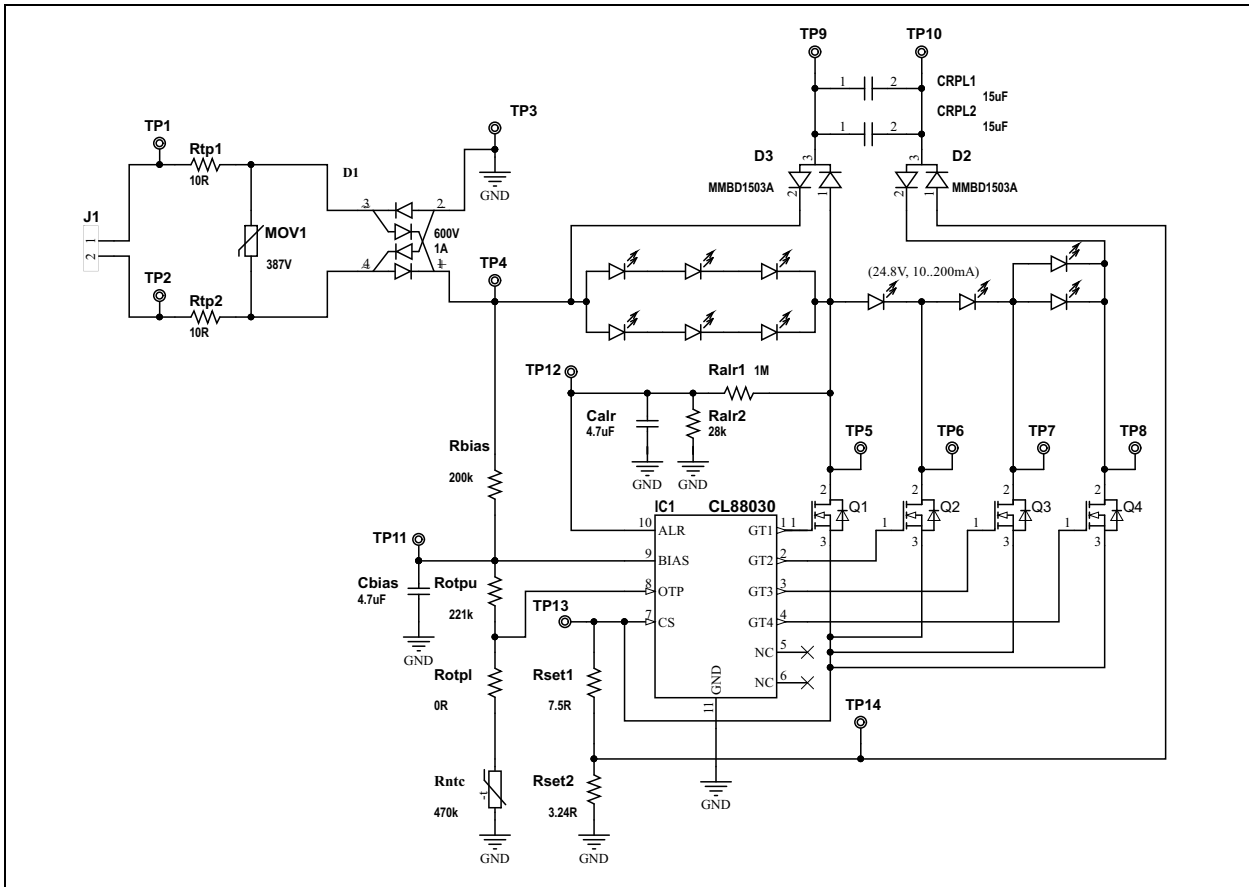

FIGURE 1-1: Typical CL88030 230 V_{AC} Offline LED Driver Evaluation Board Circuit.

1.4 WHAT IS THE CL88030 230 V_{AC} OFFLINE LED DRIVER EVALUATION BOARD (ADM00860)?

The CL88030 230 V_{AC} Offline LED Driver Evaluation Board (ADM00860) and a designated LED Load Board (ADM00861) represent a complete solution for a LED lighting application, powered directly from the 230 V_{AC} line and based on Microchip Technology's CL88030 sequential linear LED driver. The application achieves efficient operation without magnetics or conventional switching techniques and is a flexible solution that allows users to design and test their own LED Load. The available LED Load is made with 12 LEDs. Since no high frequencies are present, it exhibits inherently low conducted and radiated EMI without the need of input filters or shielding. Because the current through the LEDs follows the AC input voltage, Power Factor Correction (PFC) circuitry is not needed. With the addition of an RC network, the CL88030 is compatible with both leading-edge and trailing-edge dimmers.

Note: The LED Load (ADM00861) is provided on a double-layer 60 mm diameter FR4 (0.6 mm thick) PCB, ready to be mounted on a pin-fin heat sink. The kit includes a black anodized pin-fin heat sink and a double-sided adhesive thermal tape necessary to mount the LED Load on it. The LED Load is also developed to be used with another LED Driver board from the CL88 series (ADM00866, CL8800 LED Driver Board), so it is equipped with a selectable (by means of a jumper) NTC or PTC thermistor, making Overtemperature Protection (OTP) possible. For the current application, the selection activates the NTC thermistor by mounting the jumper between positions 2 and 3 of the J4 header.

CL88030 230 V_{AC} Offline LED Driver Evaluation Board User's Guide

The LED Driver PCB (ADM00860) is made on a 1.6 mm standard double-layer FR4. The kit includes a 10-wire flat cable to connect the LED Driver Board to the LED Load. All circuitry and hardware are provided, along with transient protection and OTP. Plug into a 230 V_{AC} outlet (50 Hz or 60 Hz) to get started.

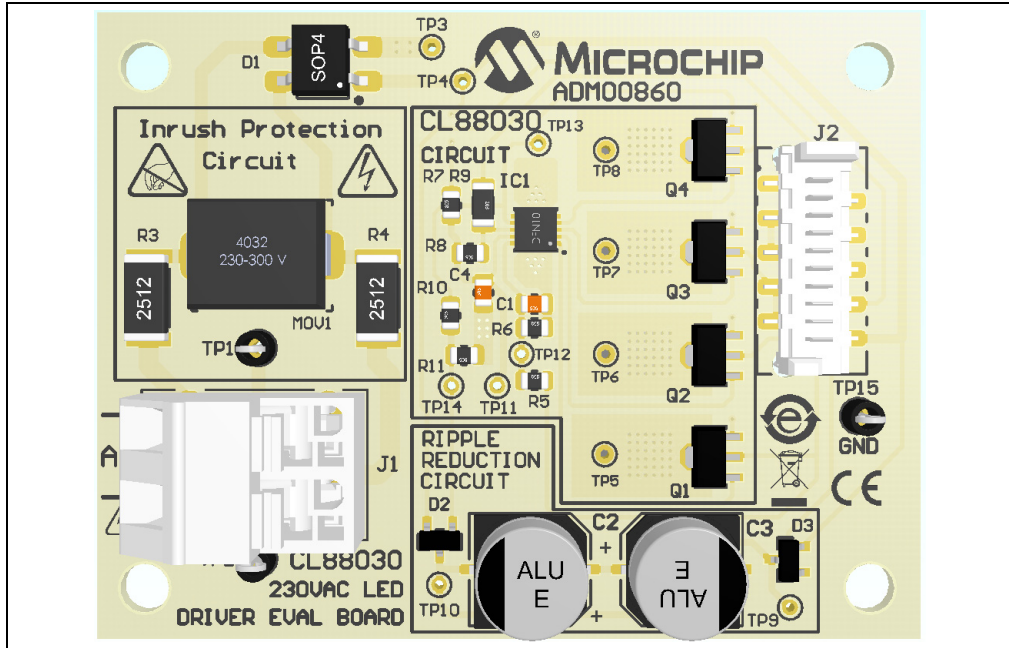

FIGURE 1-2: CL88030 230 V_{AC} Offline LED Driver Evaluation Board (ADM00860) – Top View.

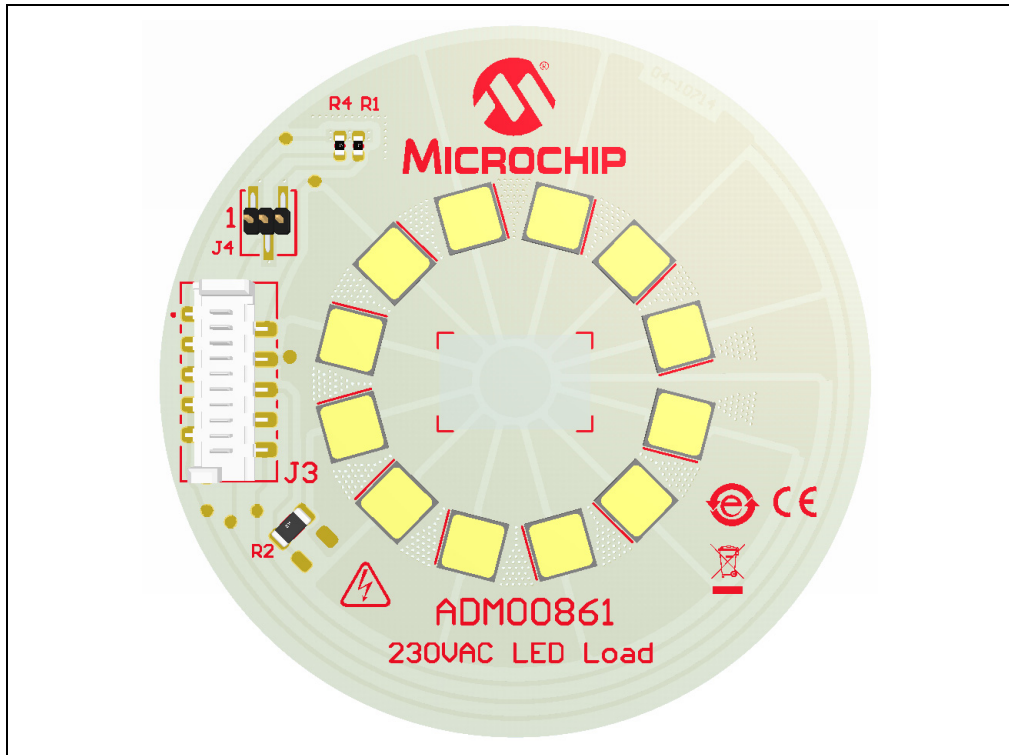

FIGURE 1-3: CL88030 LED Load Board (ADM00861) – Top View.

1.5 WHAT THE CL88030 230 V_{AC} OFFLINE LED DRIVER EVALUATION BOARD KIT CONTAINS

The CL88030 230 V_{AC} Offline LED Driver Evaluation Board kit includes:

- CL88030 230 V_{AC} Offline LED Driver Evaluation Board (ADM00860)
- 10-wire interconnection flat cable
- 4 nylon stand-offs with corresponding screws
- Important Information Sheet

Note: The CL88030 LED Load Board (ADM00861) is available for purchase from www.microchipdirect.com. The CL88030 LED Load Board kit includes:

- CL88030 LED Load Board (ADM00861)
- LED Load pin-fin heat sink
- Thermal double-sided adhesive tape
- Important Information Sheet

CL88030 230 V_{AC} Offline LED Driver Evaluation Board User's Guide

NOTES:

Chapter 2. Installation and Operation

2.1 INTRODUCTION

The CL88030 230 V_{AC} Offline LED Driver evaluation board is designed to drive a long string of inexpensive, low-current LEDs directly from the AC mains. A basic driver circuit consists of the CL88030, six resistors, four FETs and a bridge rectifier. Two to four additional components are optional for various levels of transient protection, also with a low-price NTC to assure remote OTP. No capacitors, EMI filters or power factor correction circuits are needed.

The operation principle is identical to the CL88020 one, the difference being the output FETs that are outside the IC and so, the power capability of the application is higher and the input/output capability is also higher. A string of series/parallel LEDs is tapped at four locations. Four linear current regulators sink current at each tap through a single control point and are sequentially turned on and off. High efficiency is achieved by shutting off upstream regulators when downstream regulators achieve regulation. This makes controlling overall input current easier than trying to control multiple current paths, thereby tracking the input sine wave voltage. Voltage across each regulator is minimized when conducting, providing high efficiency. It implements a self-commutation technique using only the tap currents. This technique inherently provides smooth transitions from one regulator to the next, without relying on tap voltages or the rectified AC to coordinate the transitions. The current waveform can be tailored to optimize for input voltage range, active line/load regulation, output power/current, efficiency, power factor, THD, dimmer compatibility and LED utilization. With the addition of a Resistor-Capacitor (RC) network, the driver is compatible with a wider range of phase-cut dimmers. The data sheet includes a description of the driver's operation mode, with design guidelines and examples. Additional topics include optimization/tradeoffs in performance (output power, efficiency, LED utilization, driver dissipation, output ripple, component selection, input current THD, PF and line regulation). Transient protection, OTP and ripple reduction circuit are also covered. Explanations are provided for tap sequencing, active line regulation and OTP.

2.1.1 Board Features

The CL88030 230 V_{AC} Offline LED Driver evaluation board (ADM00860) has the following features:

- Input Voltage: 230 V_{rms} +/-15%, 50/60 Hz
- Typical Output Capability: up to 130 mA
- Efficiency: over 83%
- Maximum Output Power: 14W (it depends on the cooling provided)

The CL88030 LED Load board (ADM00861) has the following features:

- 12 Osram Duris[®] S8 family LEDs (GW P9LR31.EM) Grouped in Four Taps
- A 10-wire Flat Cable Input Connector
- One NTC for OTP

2.2 GETTING STARTED

The CL88030 230 V_{AC} Offline LED Driver evaluation board is fully tested to evaluate and demonstrate the CL88030 LED Driver.

WARNING

The ADM00860 source board and ADM00861 LED Load board do NOT provide electrical isolation between the AC line and the lamp circuitry. Dangerous voltages are present when connected to the AC line. Exercise caution!

Consider the following recommendations before starting the setup process:

- Place the CL88030 LED Driver evaluation board and the LED Load assembly on a non-conductive surface when connected to the AC line.
- Do not come into contact with any of the two demonstration unit boards while they are connected to the AC line.
- Disconnect the demonstration units from the AC line before performing any work on any of them.
- Do not connect instruments having earth-referenced inputs, such as most oscilloscopes (use isolation transformers).
- It is suggested that utility power for testing is provided from an AC source with a floating output, and that differential voltage probes are used.

Failure to adhere to these guidelines may result in damage to the demo unit, the test instruments, and/or can put in danger the person conducting the tests.

2.2.1 Prerequisites

Since the power of the application is about 15 watts, for a continuous operation of the LED Load (more than 30s), attach the provided heat sink using the double-sided adhesive thermal tape by following these steps:

1. Before you start, make sure that the surface of the heat sink and of the PCB are dry and clean (use cotton made smooth material to clean if needed).
2. Detach the protection foil on the thermal tape from one side.
3. Attach the open portion of the thermal tape to the base of the heat sink.
4. Detach the second protection foil from the thermal tape.
5. Attach the PCB (ADM00861) to the heat sink.
6. Slowly press the top of the PCB to be sure that the thermal contact will be made all over the board.

2.3 SETUP PROCEDURE

Powering the CL88030 230 V_{AC} Offline LED Driver evaluation board is easy. The only connections to be made are from the LED Driver board to the LED Load assembled on a pin-fin heat sink, using the provided 10-wire flat cable, and from the LED Driver Board to the AC line via the power cord.

Follow these steps:

1. Read the getting started recommendations and precautions.
2. Set the jumper J4 on the LED Load board between positions 2 and 3 to activate the NTC for the OTP (this is specific when using the LED Load with ADM00860).
3. Connect the CL88030 LED Driver evaluation board and the CL88030 LED Load board by means of the provided 10-wire flat cable, between J2 and J3 connectors. It is recommended to exercise caution, as the connectors on the flat cable are protected from incorrect connection.
4. Connect the power cord on J1 on the LED Driver board. The input connector J1 is placed on the left side of the LED Driver board, which is marked with the inscription: AC.
5. Use a colored plexiglass above the LED Load board for eyes protection against extreme light.
6. Plug the power cord into a 230 V_{AC} outlet and apply 230 V_{AC} ±15%, 50 Hz. While it is possible for the values to be below this range, it is recommended not to exceed 277 V_{AC}. In this case, the transient protection feature is automatically activated. Line frequency is not critical (50 Hz or 60 Hz).

A variable AC power supply is needed for testing and evaluation in the laboratory. The power supply requires an output capability of at least 20W and a voltage range from 0 V_{AC} to 300 V_{AC}. This can also be obtained from an auto-transformer supplied from the mains or an electronic AC/AC power supply (for example, the Chroma ATE Inc. 61500 series).

Note: Auto-transformers do not provide isolation from the utility mains.

Figure 2-1 illustrates the connection between ADM00860 and ADM00861.

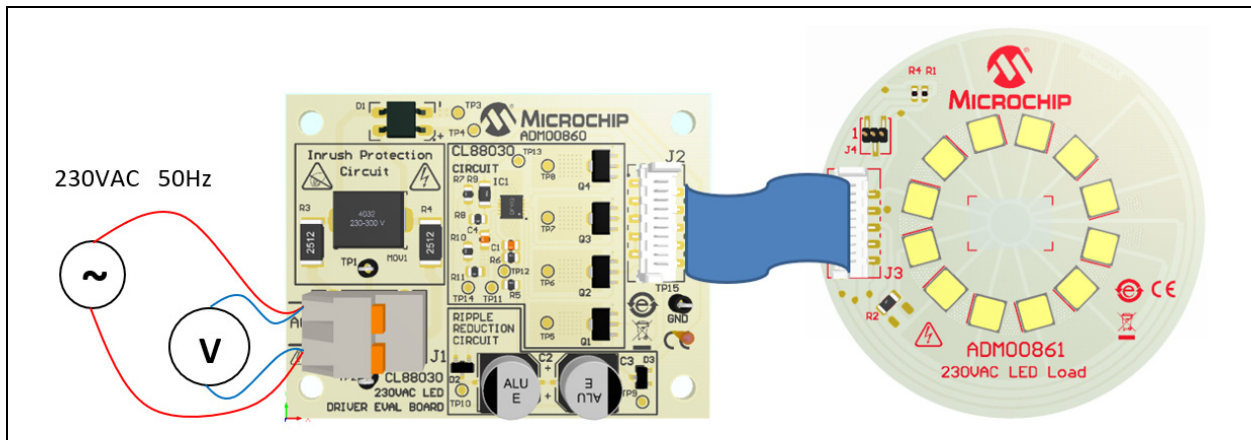

FIGURE 2-1: Connection Diagram.

2.4 HOW DOES THE CL88030 230 V_{AC} OFFLINE LED DRIVER EVALUATION BOARD SET WORK?

The CL88030 230 V_{AC} Offline LED Driver evaluation board set is designed to control the current through the four LED taps while maintaining a high-input power factor (PF) and low THD. The ADM00860 includes a CL88030 IC, which is a sequential linear LED driver controlling four taps. Tap sequencing assures the regulators are turned on and off at the proper times. Tap sequencing also controls the smooth transition from one regulator to the next, without generating EMI-causing glitches in input current. Two concepts are involved:

- The first is a single-point control. All tap currents pass through a single control point. This makes controlling overall input current easier than trying to control multiple current paths.
- The second concept is called self-commutation. Using only the tap currents themselves, this technique inherently provides smooth transitions from one regulator to the next without relying on tap voltages or the rectified AC to coordinate the transitions. This avoids having to monitor high voltages and is more precise.

These two concepts work together to properly sequence the current regulators and to provide glitch-free operation and thus avoiding conducted EMI.

The CL88030 230 V_{AC} Offline LED Driver evaluation board contains all the circuitry necessary to perform, as well as OTP, Active Line Regulation (ALR) and Ripple Reduction Circuit (RRC).

The OTP operates linearly, gradually reducing the output power as temperature increases. To accomplish this it uses an inexpensive, external NTC thermistor to remotely sense LED temperature. The thermistor is located on the LED Load board, in close proximity to the LEDs, providing near-direct LED temperature monitoring. The OTP temperature is adjustable via selection of the NTC resistance.

The ALR circuit maintains fairly constant output power over variations in AC line voltage. It is not a closed loop system that directly monitors and corrects output power. Instead, it monitors the average voltage applied to the LED string and uses it to adjust the reference voltage provided to the tap current regulators.

The RRC providing low output ripple is achieved using a capacitor and four diodes. The capacitor may consist of one or more paralleled ceramic capacitors or electrolytic. The CL88030 with RRC operates in four phases: recharge, hold-up, direct, and under certain conditions, idle. All active current paths include Segment 1 (TAP1), assuring uninterrupted light output on it during all phases of operation, excluding the idle. This reduces overall ripple, which means about 0.15 flicker index.

For more information, see the CL88020 data sheet.

2.5 BOARD TESTING

To start testing the evaluation board, follow these steps:

1. Connect the input AC source and the output LED Load, as shown in [Figure 2-1](#).
2. Use an eye protection filter to check that all the four taps light up on the LED Load Board.
3. Power the board at 230 V_{AC}, 50 Hz-60 Hz.
4. Verify each tap current through the LEDs. It should be within a range of 65 mA and 134 mA. It can be measured by separating each wire from the inter-connection 10-wire flat cable between the CL88030 LED Driver board and the CL88030 LED Load board.
5. If a variable AC source is available, set the input voltage to any value between 180 V_{AC} and 245 V_{AC}. The LED Load delivers nearly constant lumen power. The application delivers between 10W and 14W electric output power.
6. Power-down the AC source.

CL88030 230 V_{AC} Offline LED Driver Evaluation Board User's Guide

NOTES:

Appendix A. Schematic and Layouts

A.1 INTRODUCTION

This appendix contains the following schematics and layouts for the CL88030 230 V_{AC} Offline LED Driver Evaluation Board (ADM00860) and for the CL88030 230 V_{AC} LED Load Board (ADM00861):

- [Board Schematic – ADM00860](#)
- [Board Schematic – ADM00861](#)
- ADM00860:
 - [ADM00860 – Top Silk](#)
 - [ADM00860 – Top Copper and Silk](#)
 - [ADM00860 – Top Copper](#)
 - [ADM00860 – Bottom Copper and Silk](#)
- ADM00861:
 - [ADM00861 – Top Silk](#)
 - [ADM00861 – Top Copper and Silk](#)
 - [ADM00861 – Top Copper](#)
 - [ADM00861 – Bottom Copper and Silk](#)

A.2 BOARD SCHEMATIC – ADM00860

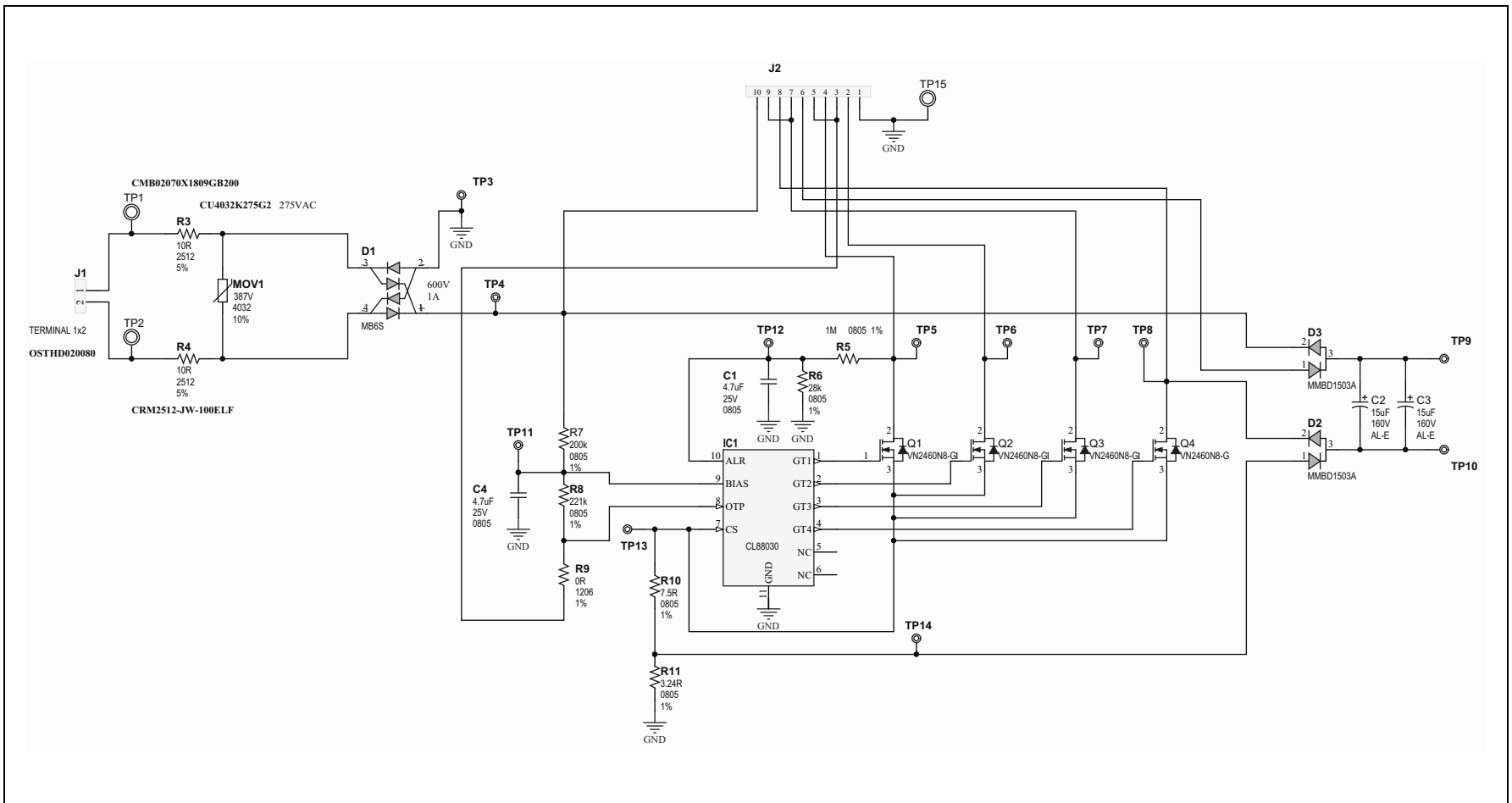

A.3 BOARD SCHEMATIC – ADM00861

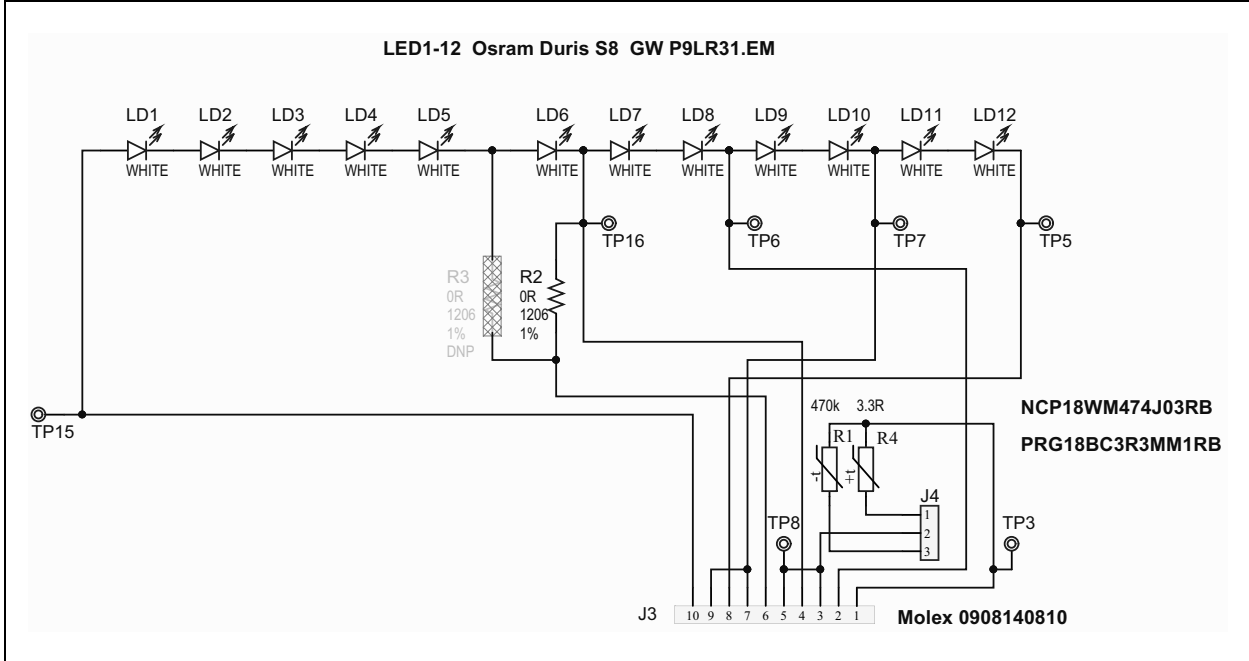

A.4 ADM00860 – TOP SILK

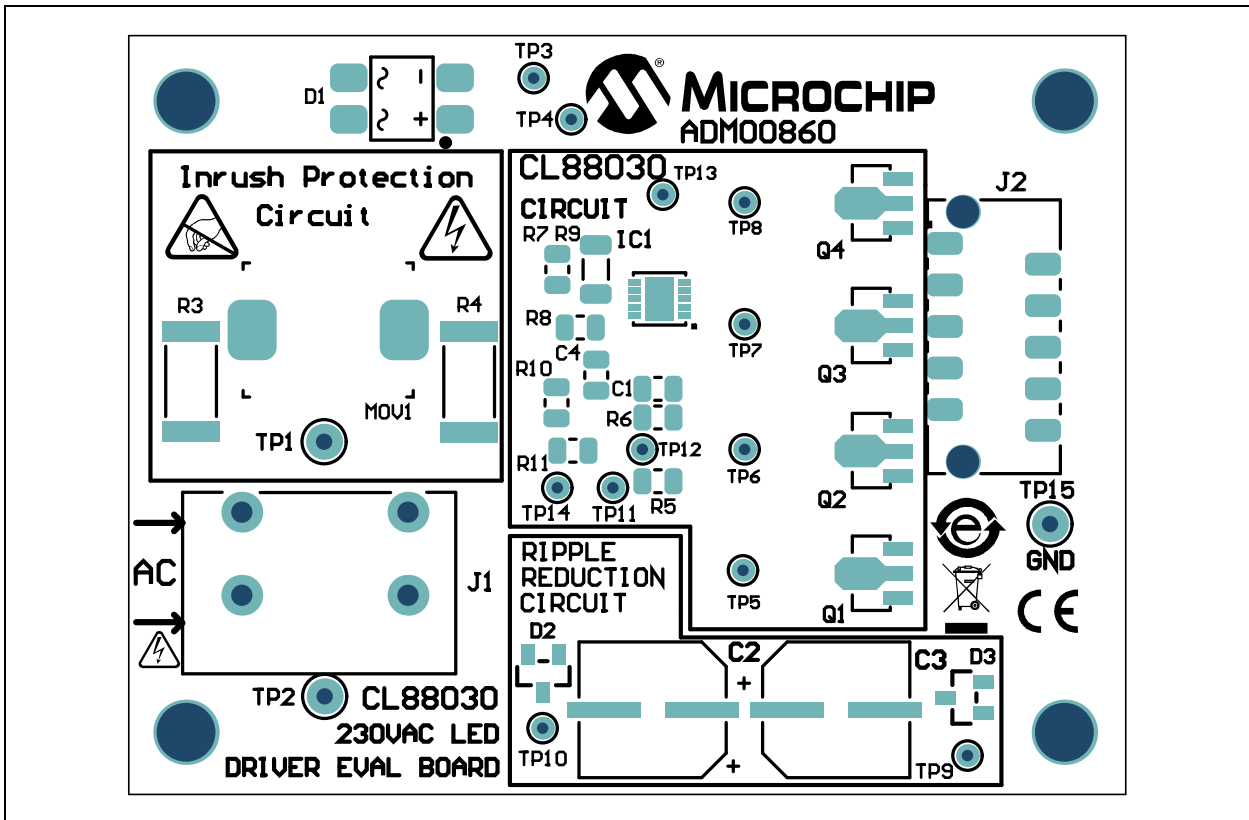

A.5 ADM00860 – TOP COPPER AND SILK

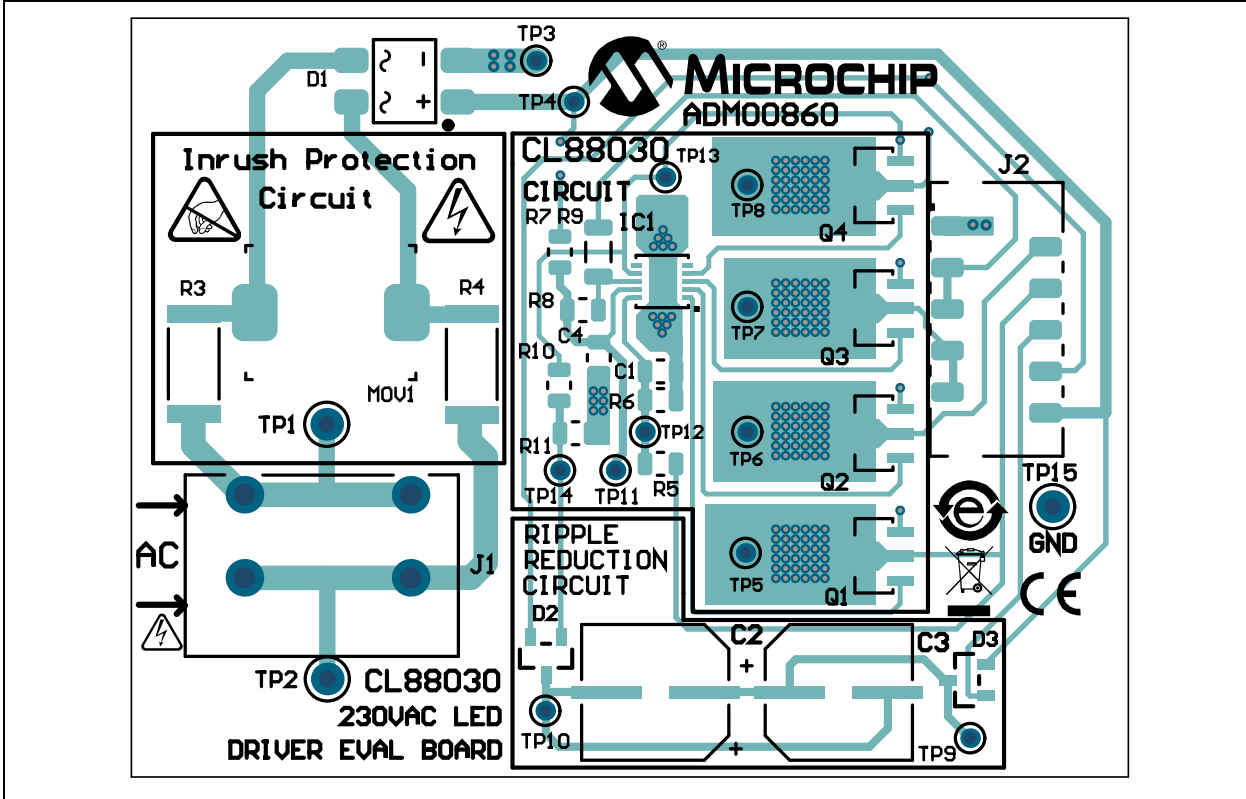

A.6 ADM00860 – TOP COPPER

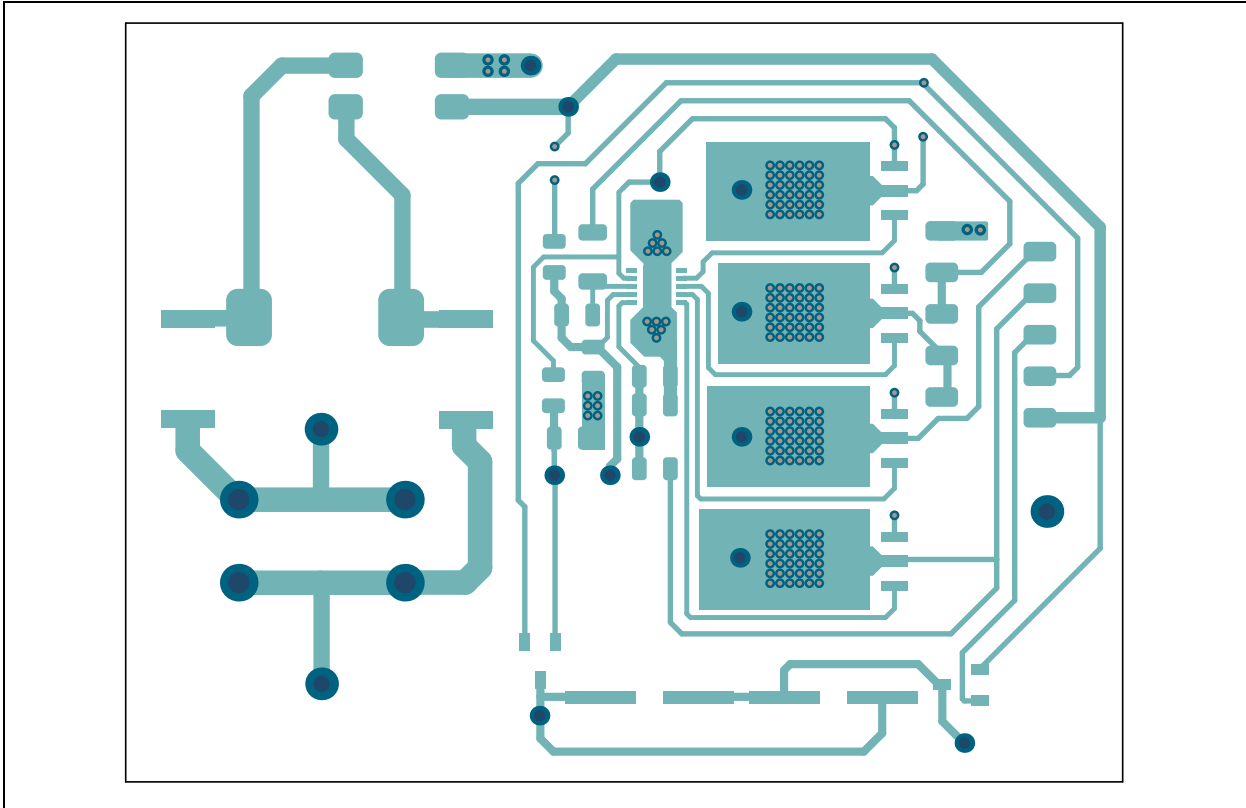

A.7 ADM00860 – BOTTOM COPPER AND SILK

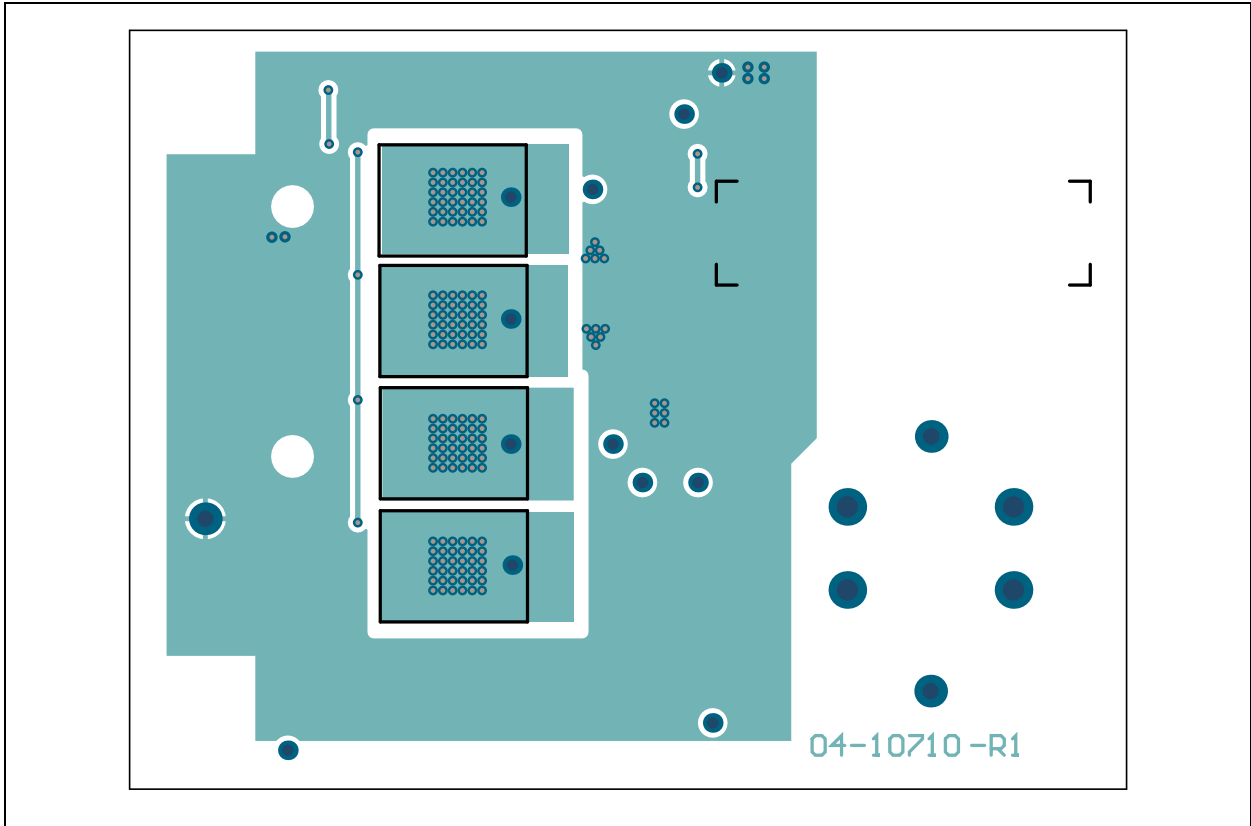

A.8 ADM00861 – TOP SILK

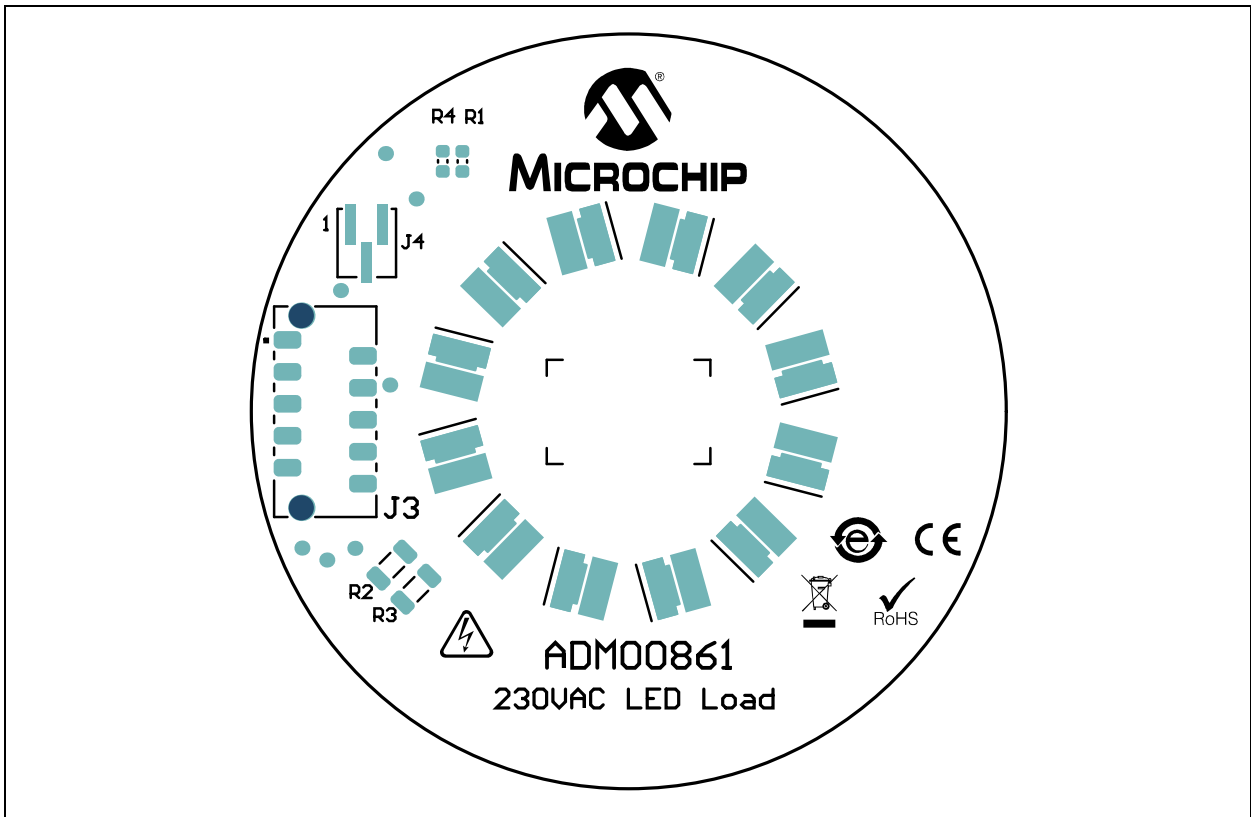

A.9 AMD00861 – TOP COPPER AND SILK

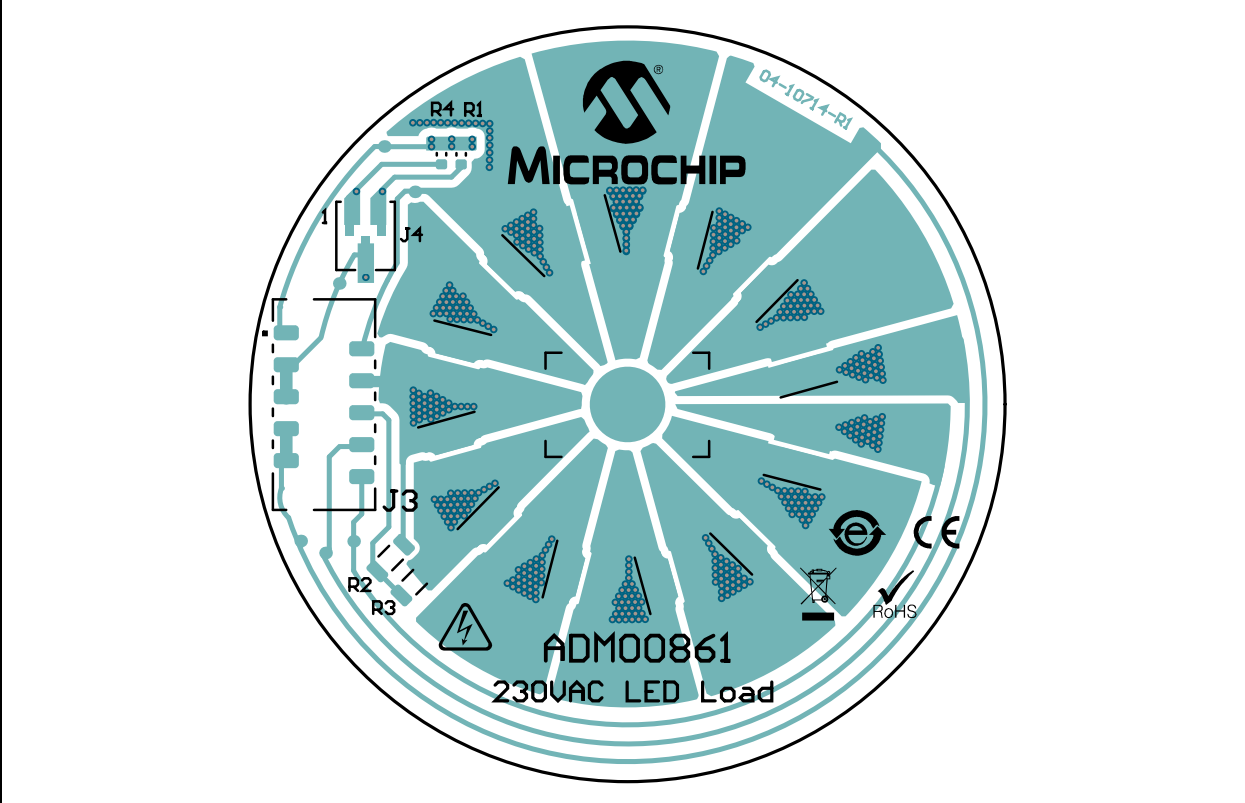

A.10 ADM00861 – TOP COPPER

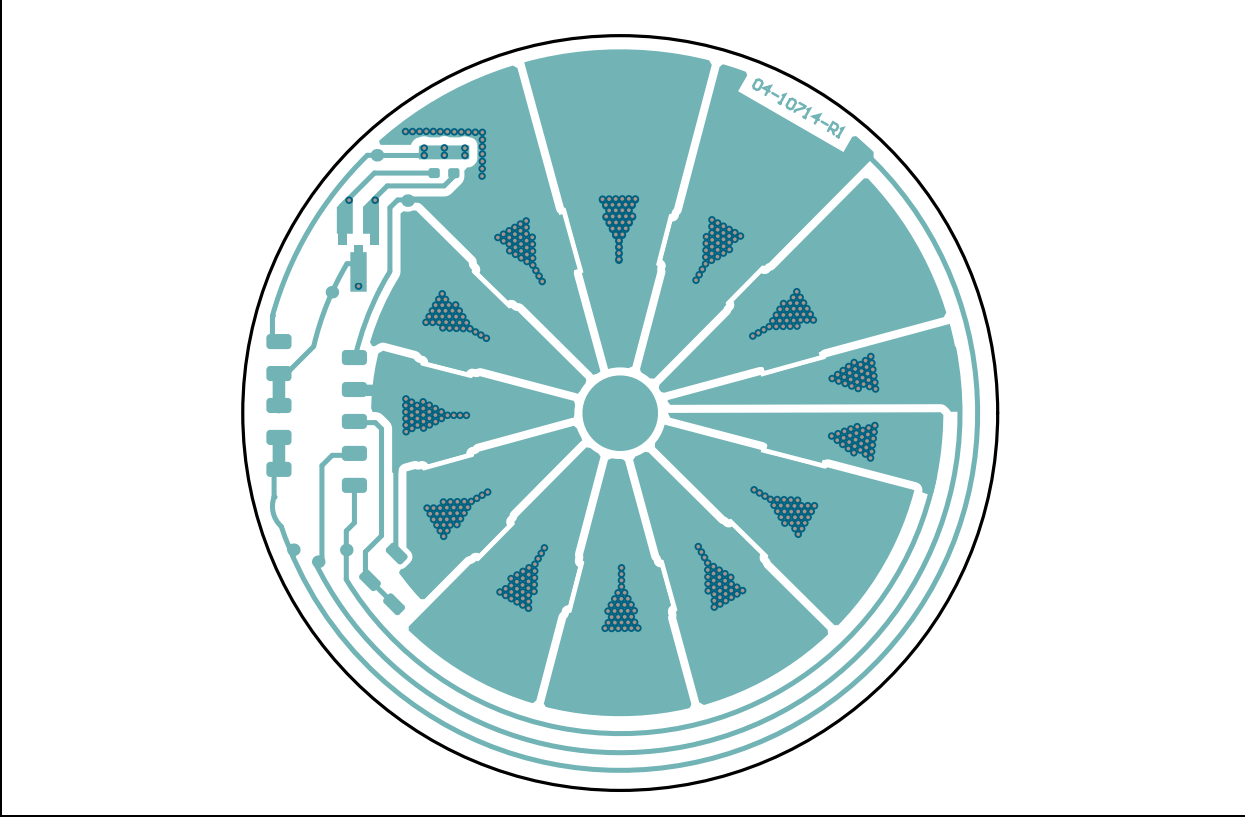

A.11 ADM00861 – BOTTOM COPPER AND SILK

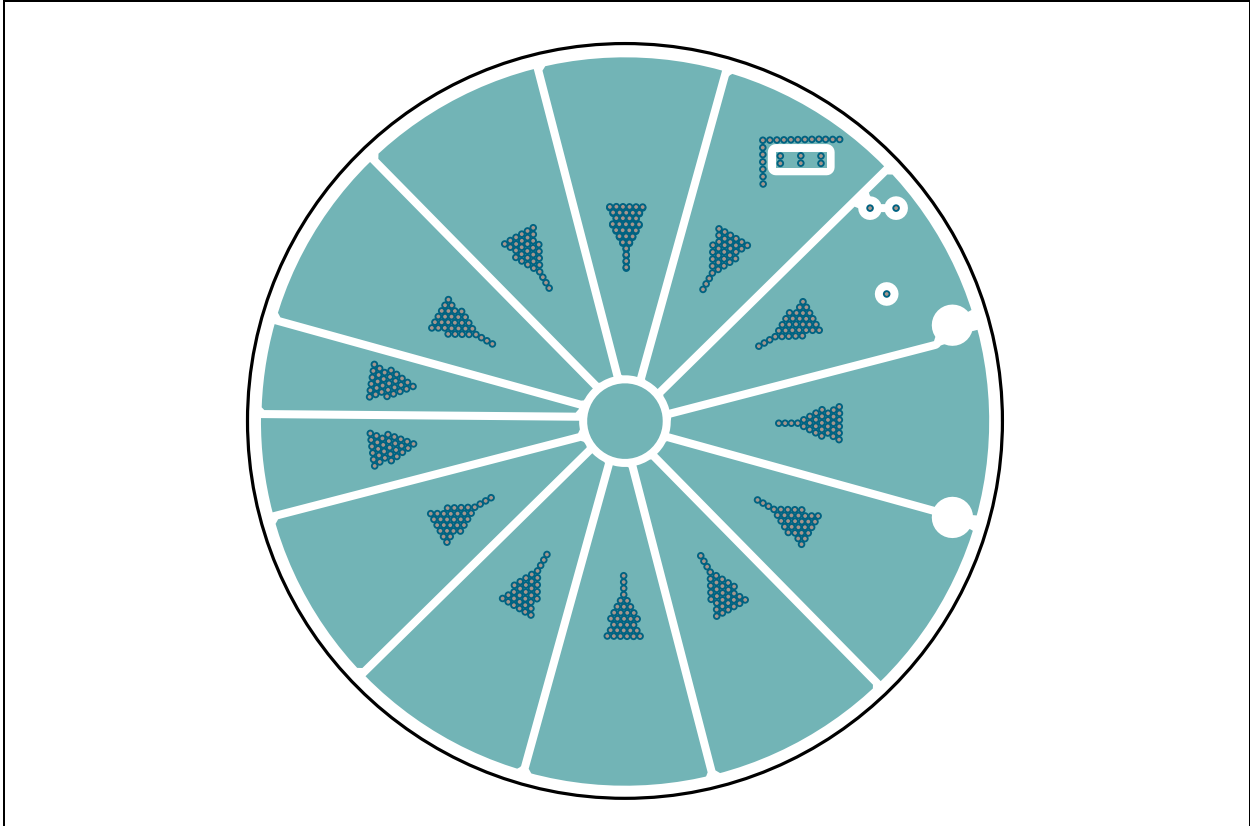

CL88030 230 V_{AC} Offline LED Driver Evaluation Board User's Guide

NOTES:

Appendix B. Bill of Materials (BOM)

TABLE B-1: BILL OF MATERIALS (BOM) FOR ADM00860

Qty.	Reference	Description	Manufacturer	Part Number
2	C1, C4	Capacitor Ceramic, 4.7 μ F, 25V, 10%, X7R, SMD 0805	TDK Corporation	C2012X7R1E475K125AB
2	C2, C3	Capacitor Aluminium, 15 μ F, 160V, 20%, SMD E	Nichicon Corporation	ULT2C150MNL1GS
1	D1	Diode, Bridge Rectifier, MB6S, 1V, 0.5A, 600V, SMD, SOIC-4	Fairchild Semiconductor®	MB6S
2	D2, D3	Diode Array, MMBD1503A, 1.1V, 200 mA, 200V, SMD, SOT-23-3	Fairchild Semiconductor	MMBD1503A
1	IC1	Microchip Analog LED Driver CL88030-E/MF, DFN-10	Microchip Technology Inc.	CL88030-E/MF
1	J1	Terminal Block, 5.08 mm, 1x2, Female, 16-22AWG, 12A, TH, R/A	On-Shore Technology, Inc.	OSTHD020080
1	J2	Connector Header-1.27 Male, 1x10, Tin, SMD Vertical	Digi-Key® Electronics	WM19277-ND
1	MOV1	Varistor, 430V, 1.2 kA, SMD 4032	EPCOS TDK	B72660M0271K093
1	PCB	CL88030 230 V _{AC} Offline LED Driver Evaluation Board – Printed Circuit Board	Microchip Technology Inc.	04-10710-R1
4	Q1, Q2, Q3, Q4	Transistor FET, N-Channel, 600V, 200 mA, 1.6W, SOT-89	Microchip Technology Inc.	VN2460N8-G
2	R3, R4	Resistor, TKF, 10R, 5%, 1W, SMD 2512	Panasonic® – ECG	ERJ-1TYJ100U
1	R5	Resistor, TKF, 1M, 1%, 1/8W, SMD 0805	Panasonic – ECG	ERJ-6ENF1004V
1	R6	Resistor, TKF, 28k, 1%, 1/8W, SMD 0805	Vishay®/Dale	CRCW080528K0FKEA
1	R7	Resistor, TKF, 200k, 1%, 1/8W, SMD 0805	Multicomp Inc.	MCPWR05FTEW2003
1	R8	Resistor, TKF, 221k, 1%, 1/8W, SMD 0805	Vishay/Dale	CRCW0805221KFKEA
1	R9	Resistor, TKF, 0R, 1%, 1/4W, SMD 1206	TT Electronics Plc.	WCR1206-R005JI
1	R10	Resistor, TKF, 7.5R, 1%, 1/8W, SMD 0805	Vishay/Dale	CRCW08057R50FKEA
1	R11	Resistor, TKF, 3.24R, 1%, 1/8W, SMD 0805	Vishay/Dale	CRCW08053R24FKEA
3	TP1, TP2, TP15	Miscellaneous, Test Points, Multi-Purpose, Miniature, Black	Keystone Electronics Corp.	5001

Note 1: The components listed in this Bill of Materials are representative of the PCB assembly. The released BOM used in manufacturing uses all RoHS-compliant components.

CL88030 230 V_{AC} Offline LED Driver Evaluation Board User's Guide

TABLE B-2: BILL OF MATERIALS (BOM) FOR ADM00860 - MECHANICAL PARTS

Qty	Reference	Description	Manufacturer	Part Number
1	CBL1	Mechanical HW Cable, Picoflex™, IDT to IDT, 10-COND, 250 mm	Molex®	0923151025
4	HS1, HS2, HS3, HS4	Mechanical HW Heat Sink, L8.5 mm x W6.35 mm x H4.8 mm, Black	Assmann Electronics Inc.	V5618A
1	LABEL1	Label Assembly, W/REV Level (Small Modules), PER MTS-0002		
4	SCR1, SCR2, SCR3, SCR4	Mechanical HW Screw, #6-32 x 1/4", PanHead, PHIL, Nylon	B&F Fasteners Supply	NY PMS 632 0025 PH
4	STANDOFF1, STANDOFF2, STANDOFF3, STANDOFF4	Mechanical HW Stand-Off, #6-32 x 3/8", F, HEX, Nylon	Keystone Electronics Corp.	1903B
1	TAPE1	Mechanical HW, Tape, Thermal Sheet, L254W254, custom 9 x 7 mm	Bergquist Company GmbH	BP100-0.008-00-1010

Note 1: The components listed in this Bill of Materials are representative of the PCB assembly. The released BOM used in manufacturing uses all RoHS-compliant components.

TABLE B-3: BILL OF MATERIALS (BOM) FOR ADM00861

Qty.	Reference	Description	Manufacturer	Part Number
1	HS2	Mechanical HW Heat Sink, D60 mm x H30 mm, 9.1W, Black	MechaTronix Kaohsiung Co., Ltd.	LPF60A30-5-B
1	J3	Connector Header, 1.27 mm, Male, 1x10, Tin, SMD, Vertical	Digi-Key Electronics	WM19277-ND
1	J4	Connector Header, Male, 1x3, 1.27 mm, AU, SMD	Harwin Plc.	M50-3630342
1	LABEL1	Label, AIPD Board Assembly		
12	LD1, LD2, LD3, LD4, LD5, LD6, LD7, LD8, LD9, LD10, LD11, LD12	Diode LED, White, 24.8V, 150 mA, 500 lm, 2700K, SMD, L5W5H0.7	OSRAM Opto Semiconductors GmbH	GW P9LR31.EM-PPPR-XX5 8-1-150-R18
1	PCB1	CL88030 LED Load Board – Printed Circuit Board	Microchip Technology Inc.	04-10714-R1
1	R1	Resistor NTC Thermistor, 470k, 5%, 100 mW, 0603	Murata Electronics North America, Inc.	NCP18WM474J03RB
1	R2	Resistor, TKF, 0R, 1%, 1/4W, SMD, 1206	TT Electronics Plc.	WCR1206-R005JI
0	R3	DO NOT POPULATE	TT Electronics Plc.	WCR1206-R005JI
1	R4	Resistor, Fuse Resettable, 180 mA, 16V, PTC, SMD, 0603	Murata Electronics North America, Inc.	PRG18BC3R3MM1RB
1	SH4	Mechanical HW Jumper, 1.27 mm, 1x2, Gold	Sullins Connector Solutions	NPB02SVAN-RC
1	TAPE 1	Mechanical HW, Tape, Thermal Sheet, L254W254, custom D60 mm	Bergquist Company GmbH	BP100-0.008-00-1010

Note 1: The components listed in this Bill of Materials are representative of the PCB assembly. The released BOM used in manufacturing uses all RoHS-compliant components.

Appendix C. Plots and Waveforms

C.1 CL88030 230 V_{AC} OFFLINE LED DRIVER EVALUATION BOARD TYPICAL WAVEFORMS

C.1.1 Total Output Current at 230 V_{AC} and 255 V_{AC} Input

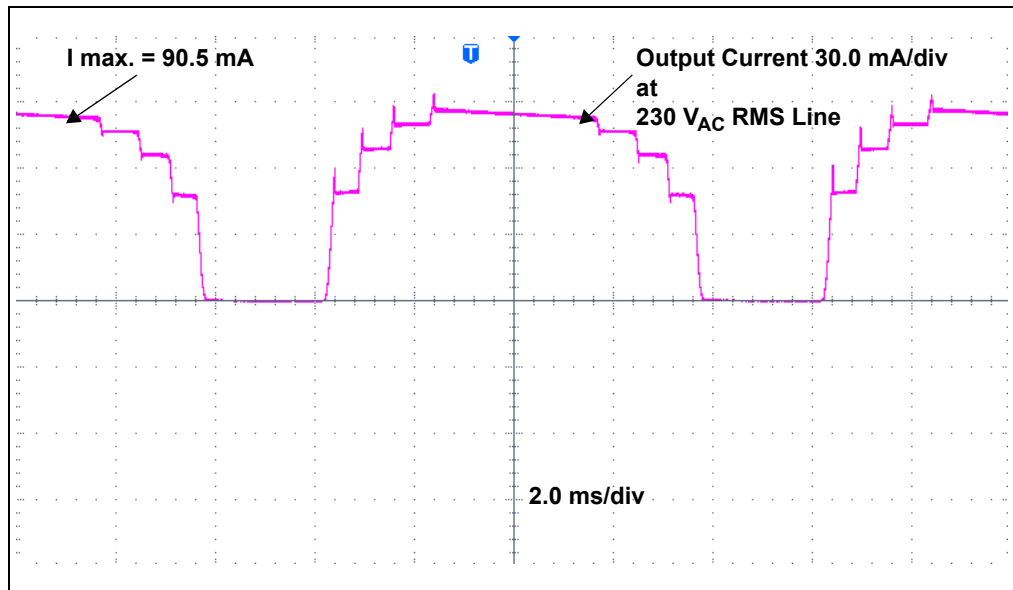

FIGURE C-1: Total Output Current at 230 V_{AC} Line Input Voltage.

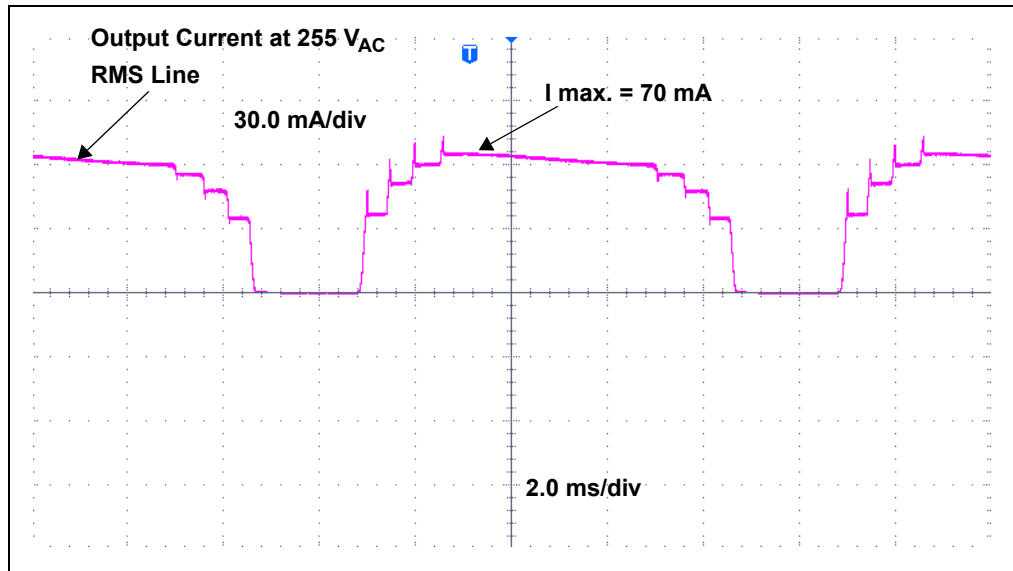

FIGURE C-2: Total Output Current at 255 V_{AC} Line Input Voltage.

C.1.2 TAPs 1, 2, 3, 4 Currents at 230 V_{AC}

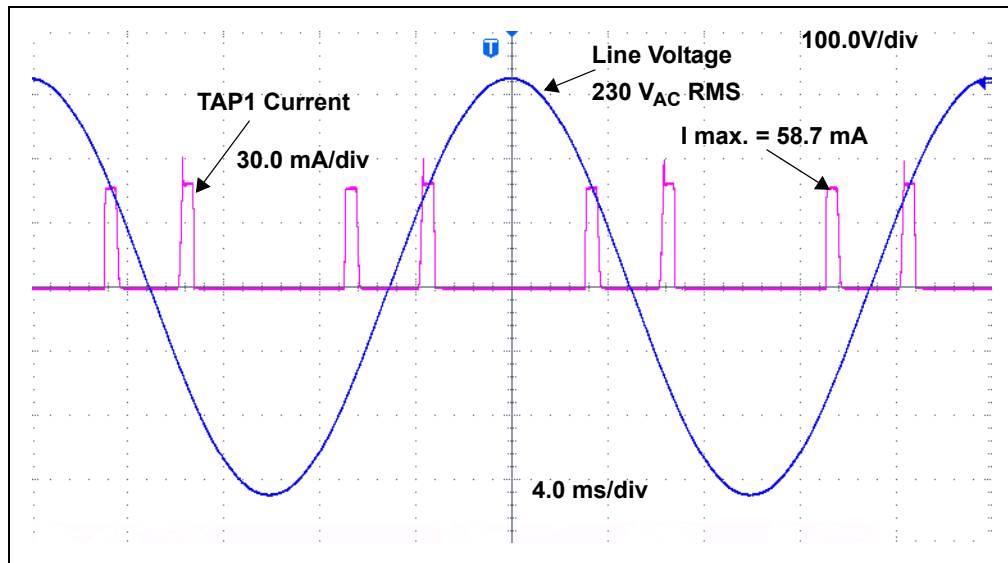

FIGURE C-3: TAP1 Current at 230 V_{AC} Line Input Voltage.

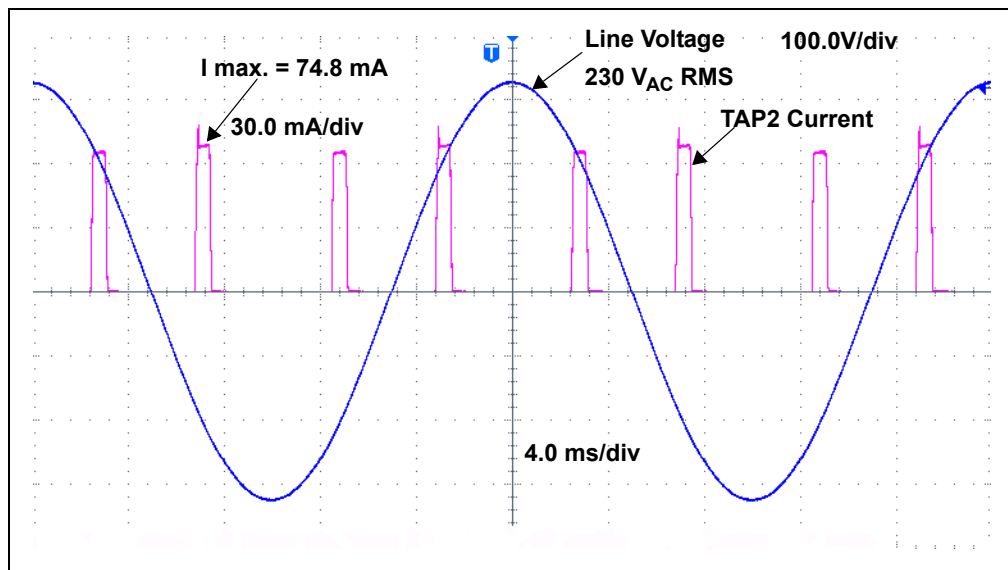

FIGURE C-4: TAP2 Current at 230 V_{AC} Line Input Voltage.

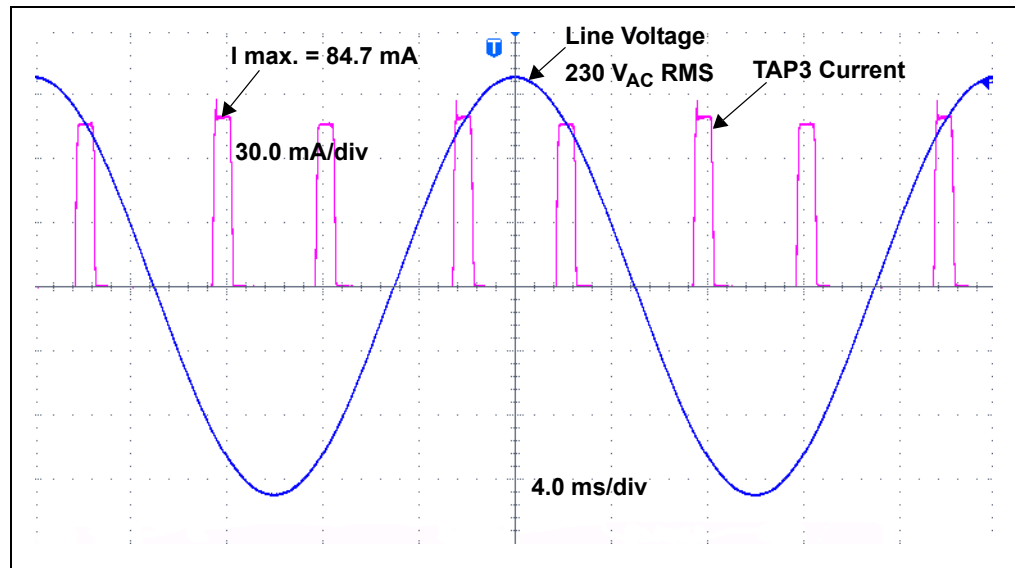

FIGURE C-5: TAP3 Current at 230 V_{AC} Line Input Voltage.

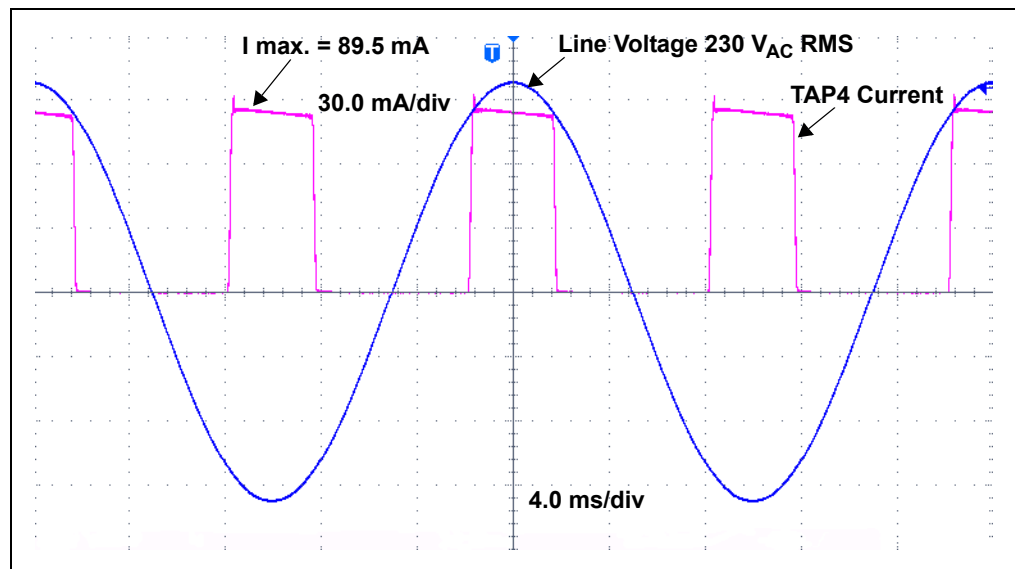

FIGURE C-6: TAP4 Current at 230 V_{AC} Line Input Voltage.

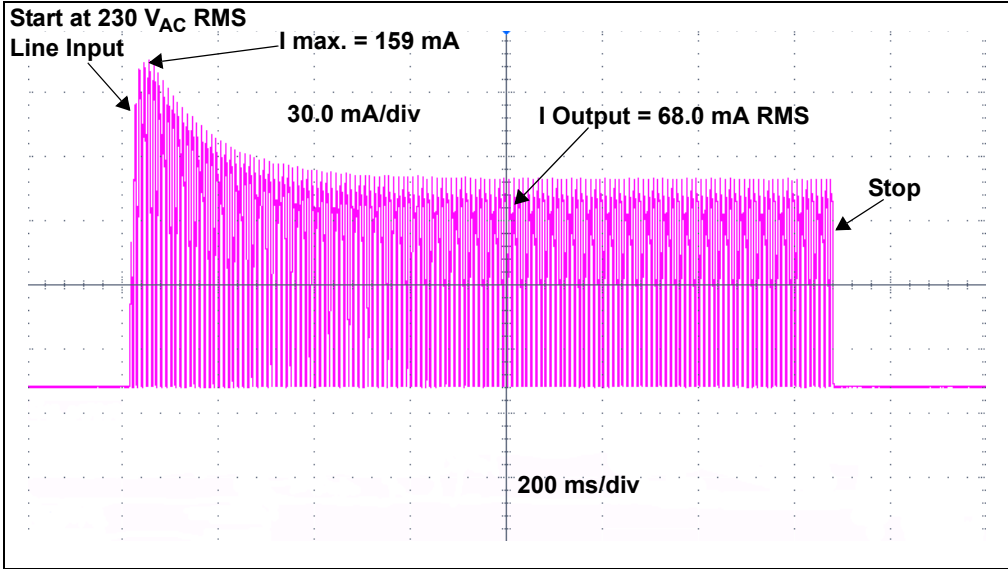

FIGURE C-7: Output Current on Startup at 230 V_{AC} Line Input Voltage.

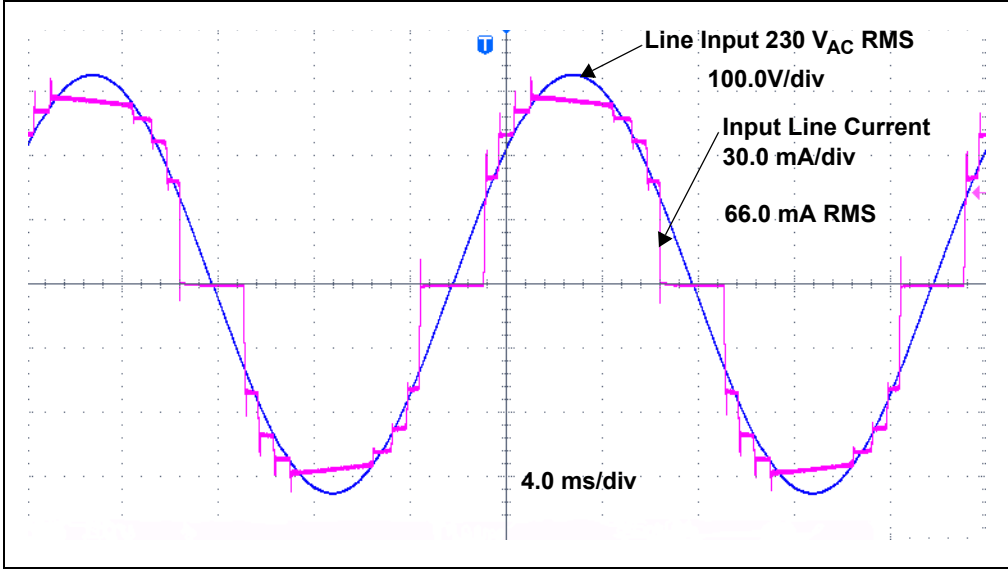

FIGURE C-8: Input Current and Line Input Voltage Waveforms.

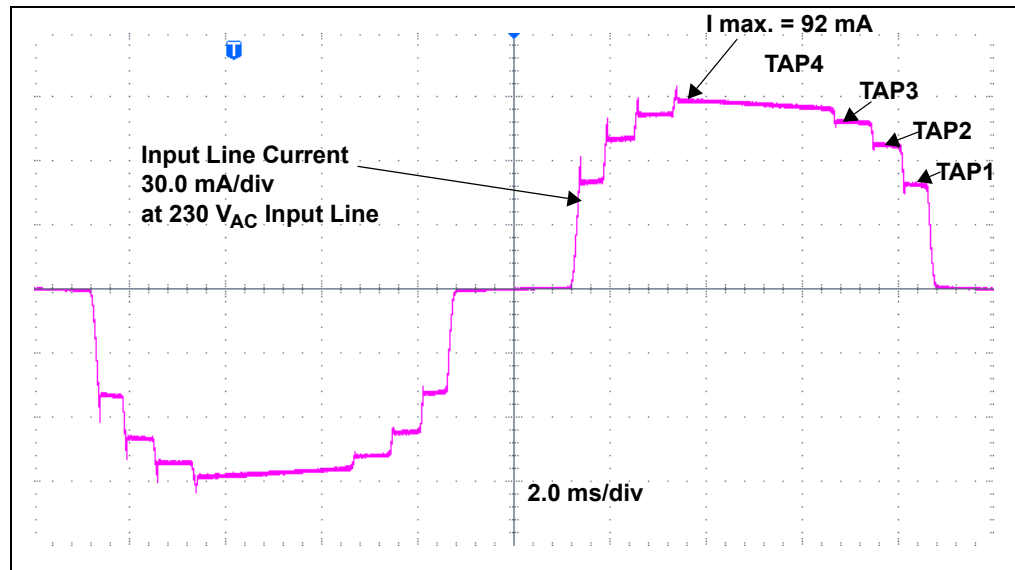

FIGURE C-9: Input Current Waveform – TAPs Commutation.

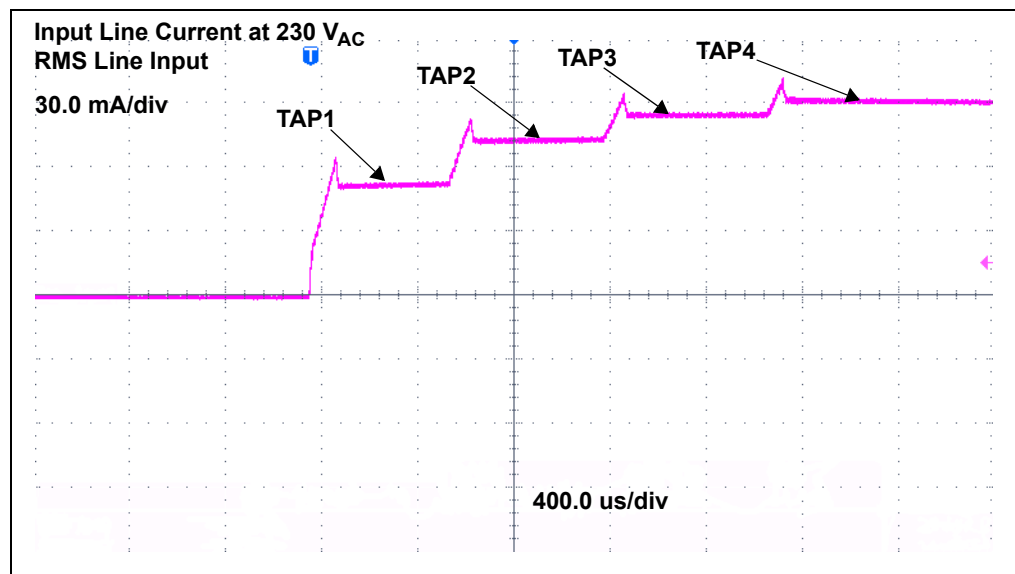

FIGURE C-10: Input Current Waveform – TAPs 1-4 Commutation Detail.

C.1.3 Output Current with Ripple Reduction Circuit (RRC) at 230 V_{AC} Input

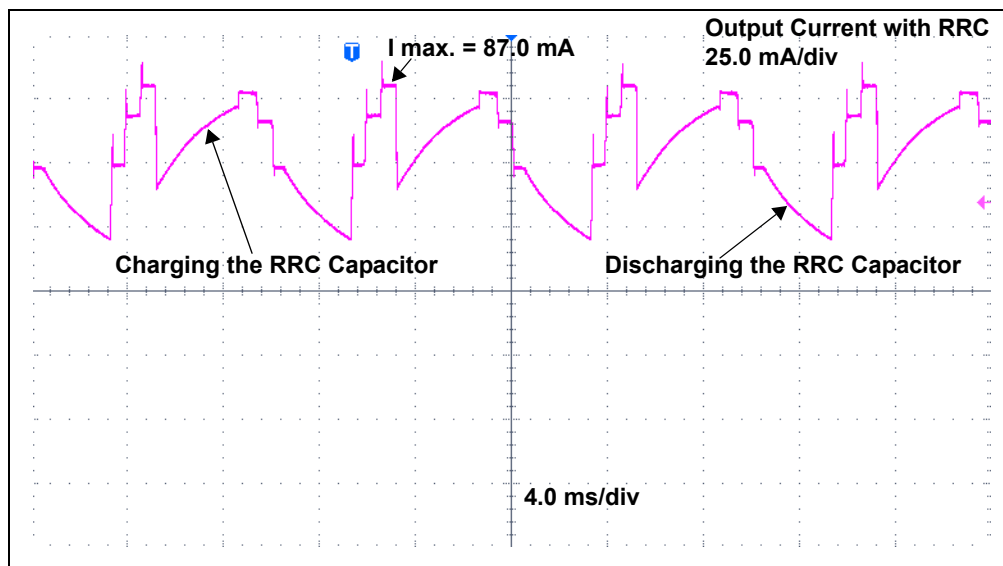

FIGURE C-11: Output Current with RRC at 230 V_{AC} Line Input Voltage.

C.2 CL88030 230 V_{AC} OFFLINE LED DRIVER EVALUATION BOARD TYPICAL MEASUREMENTS

Note: The graphs and tables provided following this note are a statistical summary based on a limited number of samples and are provided for informational purposes only. The performance characteristics listed herein are not tested or guaranteed. In some graphs or tables, the data presented may be outside the specified operating range (e.g., outside specified power supply range) and therefore outside the warranted range.

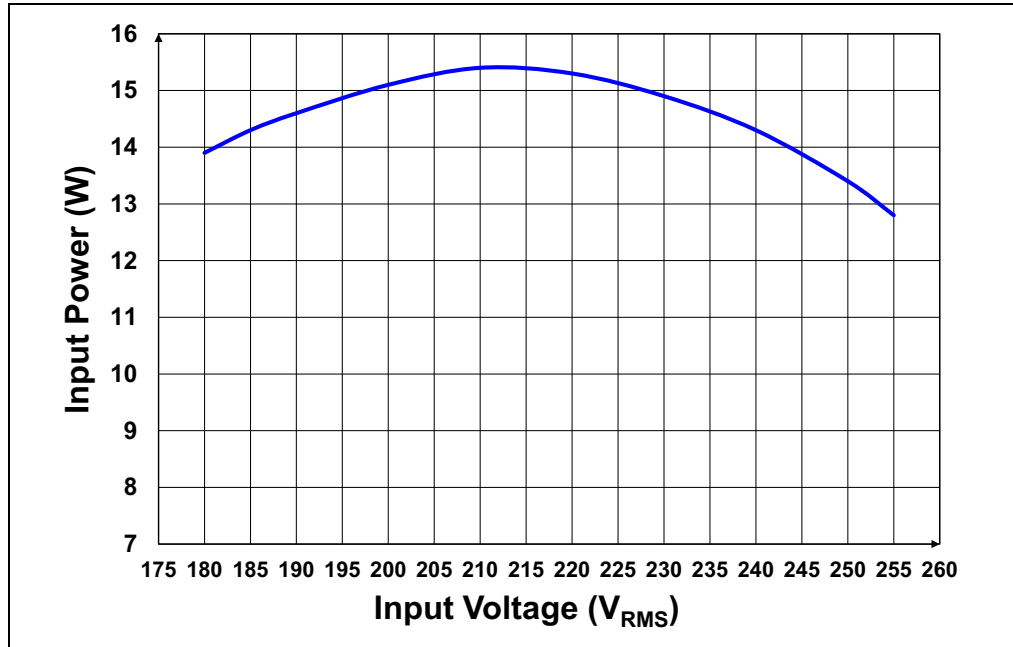

FIGURE C-12: *Input Power vs. Input Voltage (V_{RMS}).*

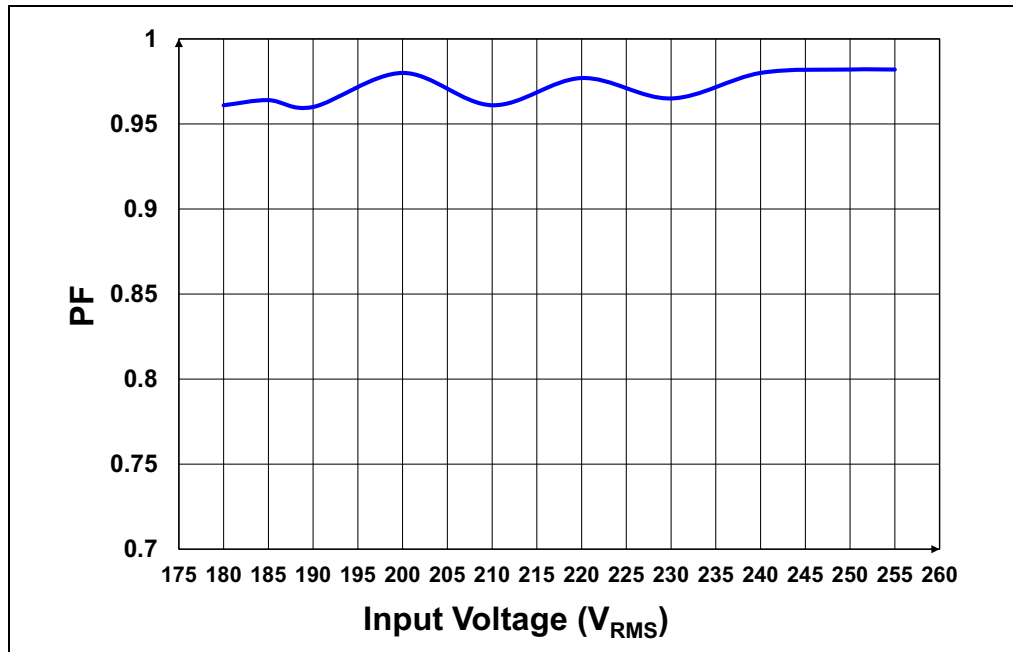

FIGURE C-13: *Power Factor vs. Input Voltage (V_{RMS}).*

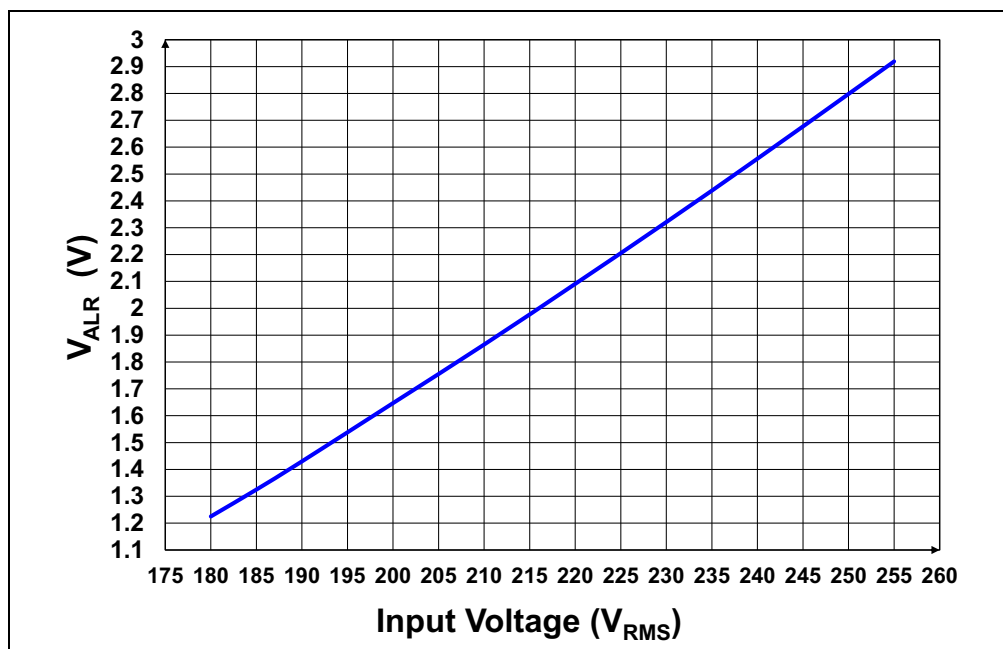

FIGURE C-14: V_{ALR} Pin vs. Input Line Voltage (V_{RMS}).

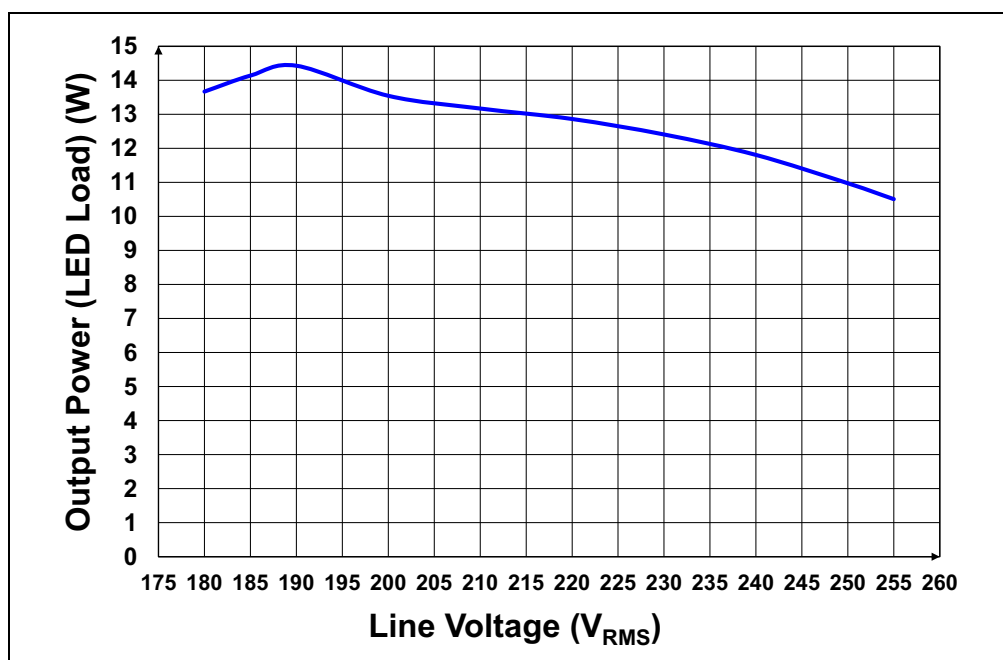

FIGURE C-15: Output Power (Electric) vs. Input Line Voltage (V_{RMS}).

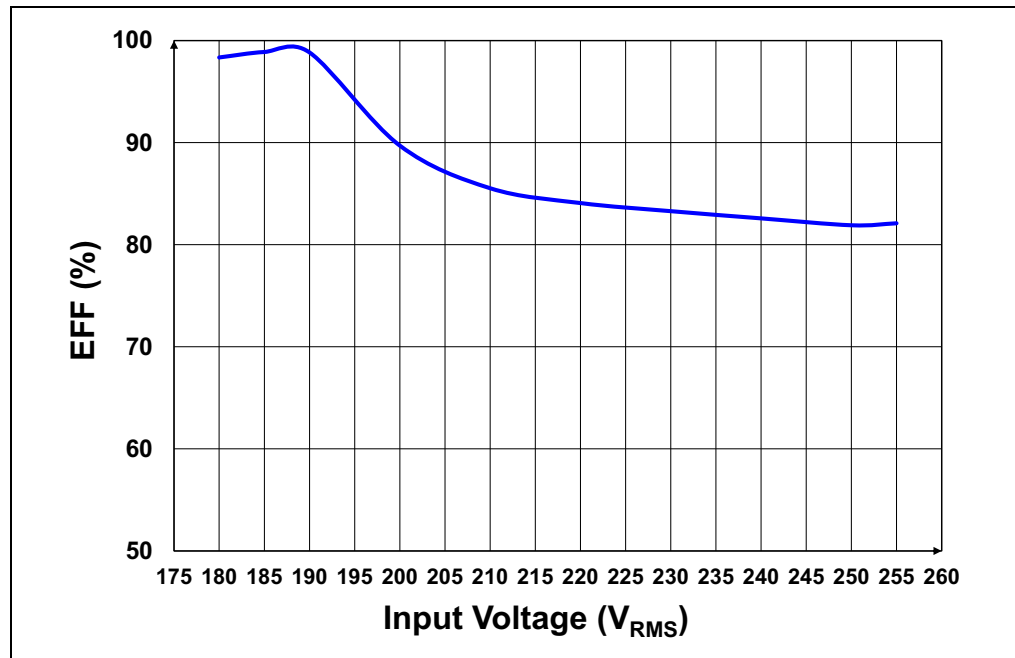

FIGURE C-16: Electric Efficiency vs. Input Line Voltage (V_{RMS}).

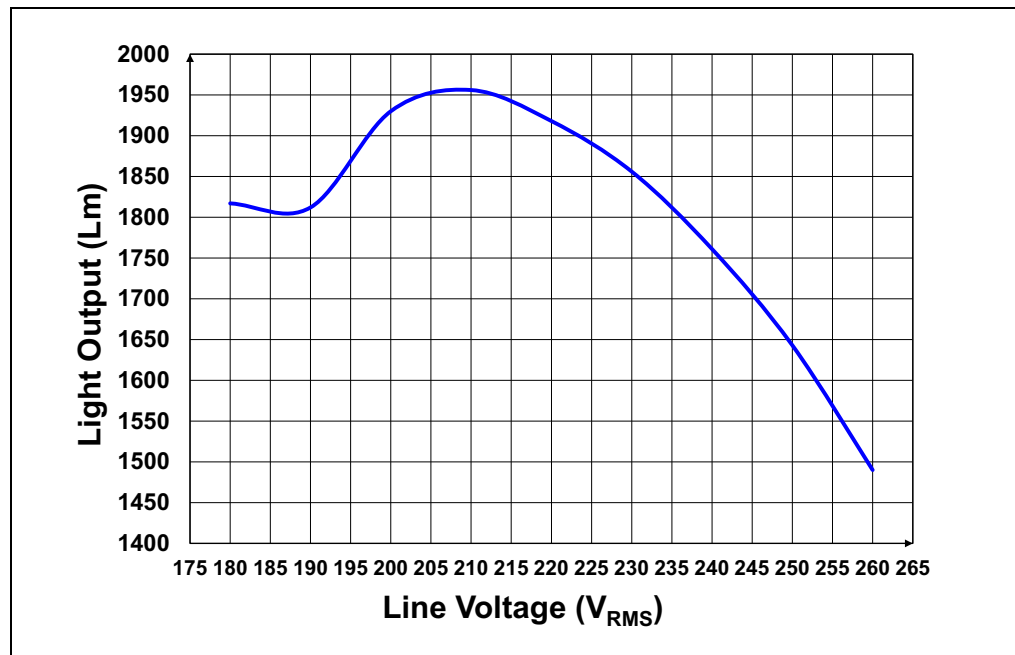

FIGURE C-17: Light Output vs. Input Voltage (V_{RMS}).

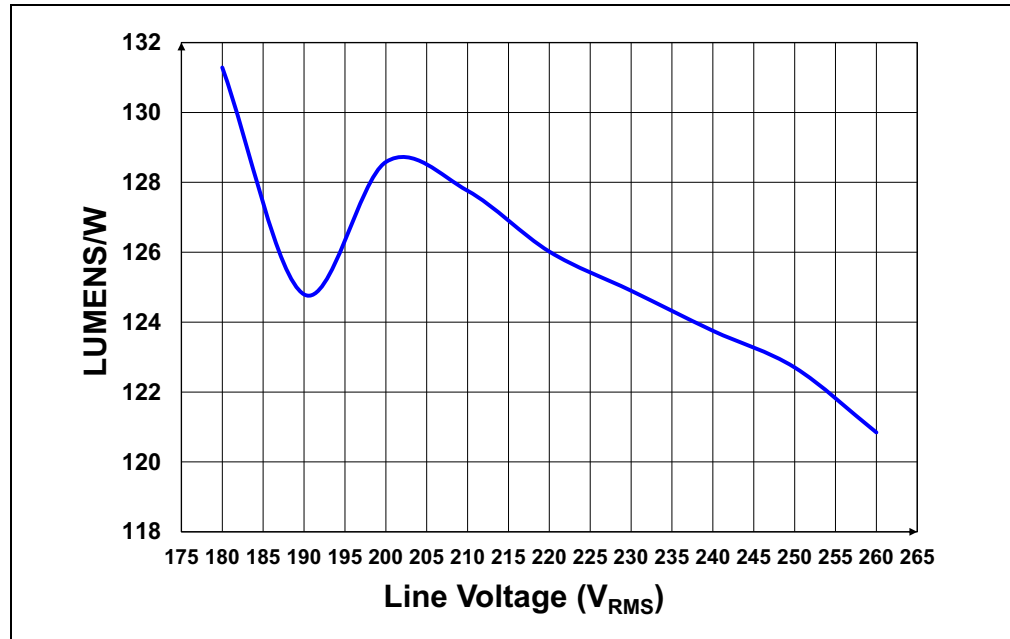

FIGURE C-18: Luminous Efficacy (Lumens/W) vs. Input Voltage (V_{RMS}).



MICROCHIP

Worldwide Sales and Service

AMERICAS

Corporate Office
2355 West Chandler Blvd.
Chandler, AZ 85224-6199
Tel: 480-792-7200
Fax: 480-792-7277
Technical Support:
<http://www.microchip.com/support>
Web Address:
www.microchip.com

Atlanta

Duluth, GA
Tel: 678-957-9614
Fax: 678-957-1455

Austin, TX

Tel: 512-257-3370

Boston

Westborough, MA
Tel: 774-760-0087
Fax: 774-760-0088

Chicago

Itasca, IL
Tel: 630-285-0071
Fax: 630-285-0075

Dallas

Addison, TX
Tel: 972-818-7423
Fax: 972-818-2924

Detroit

Novi, MI
Tel: 248-848-4000

Houston, TX

Tel: 281-894-5983

Indianapolis

Noblesville, IN
Tel: 317-773-8323
Fax: 317-773-5453
Tel: 317-536-2380

Los Angeles

Mission Viejo, CA
Tel: 949-462-9523
Fax: 949-462-9608
Tel: 951-273-7800

Raleigh, NC

Tel: 919-844-7510

New York, NY

Tel: 631-435-6000

San Jose, CA

Tel: 408-735-9110
Tel: 408-436-4270

Canada - Toronto

Tel: 905-695-1980
Fax: 905-695-2078

ASIA/PACIFIC

Australia - Sydney
Tel: 61-2-9868-6733

China - Beijing
Tel: 86-10-8569-7000

China - Chengdu
Tel: 86-28-8665-5511

China - Chongqing
Tel: 86-23-8980-9588

China - Dongguan
Tel: 86-769-8702-9880

China - Guangzhou
Tel: 86-20-8755-8029

China - Hangzhou
Tel: 86-571-8792-8115

China - Hong Kong SAR
Tel: 852-2943-5100

China - Nanjing
Tel: 86-25-8473-2460

China - Qingdao
Tel: 86-532-8502-7355

China - Shanghai
Tel: 86-21-3326-8000

China - Shenyang
Tel: 86-24-2334-2829

China - Shenzhen
Tel: 86-755-8864-2200

China - Suzhou
Tel: 86-186-6233-1526

China - Wuhan
Tel: 86-27-5980-5300

China - Xian
Tel: 86-29-8833-7252

China - Xiamen
Tel: 86-592-2388138

China - Zhuhai
Tel: 86-756-3210040

ASIA/PACIFIC

India - Bangalore
Tel: 91-80-3090-4444

India - New Delhi
Tel: 91-11-4160-8631

India - Pune
Tel: 91-20-4121-0141

Japan - Osaka
Tel: 81-6-6152-7160

Japan - Tokyo
Tel: 81-3-6880-3770

Korea - Daegu
Tel: 82-53-744-4301

Korea - Seoul
Tel: 82-2-554-7200

Malaysia - Kuala Lumpur
Tel: 60-3-7651-7906

Malaysia - Penang
Tel: 60-4-227-8870

Philippines - Manila
Tel: 63-2-634-9065

Singapore
Tel: 65-6334-8870

Taiwan - Hsin Chu
Tel: 886-3-577-8366

Taiwan - Kaohsiung
Tel: 886-7-213-7830

Taiwan - Taipei
Tel: 886-2-2508-8600

Thailand - Bangkok
Tel: 66-2-694-1351

Vietnam - Ho Chi Minh
Tel: 84-28-5448-2100

EUROPE

Austria - Wels
Tel: 43-7242-2244-39
Fax: 43-7242-2244-393

Denmark - Copenhagen
Tel: 45-4450-2828
Fax: 45-4485-2829

Finland - Espoo
Tel: 358-9-4520-820

France - Paris
Tel: 33-1-69-53-63-20
Fax: 33-1-69-30-90-79

Germany - Garching
Tel: 49-8931-9700

Germany - Haan
Tel: 49-2129-3766400

Germany - Heilbronn
Tel: 49-7131-67-3636

Germany - Karlsruhe
Tel: 49-721-625370

Germany - Munich
Tel: 49-89-627-144-0
Fax: 49-89-627-144-44

Germany - Rosenheim
Tel: 49-8031-354-560

Israel - Ra'anana
Tel: 972-9-744-7705

Italy - Milan
Tel: 39-0331-742611
Fax: 39-0331-466781

Italy - Padova
Tel: 39-049-7625286

Netherlands - Drunen
Tel: 31-416-690399
Fax: 31-416-690340

Norway - Trondheim
Tel: 47-7289-7561

Poland - Warsaw
Tel: 48-22-3325737

Romania - Bucharest
Tel: 40-21-407-87-50

Spain - Madrid
Tel: 34-91-708-08-90
Fax: 34-91-708-08-91

Sweden - Gothenberg
Tel: 46-31-704-60-40

Sweden - Stockholm
Tel: 46-8-5090-4654

UK - Wokingham
Tel: 44-118-921-5800
Fax: 44-118-921-5820