

# MUR820 - MUR860

8.0AMP. Glass Passivated Super Fast Rectifiers  
TO-220AC

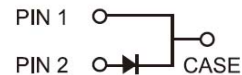
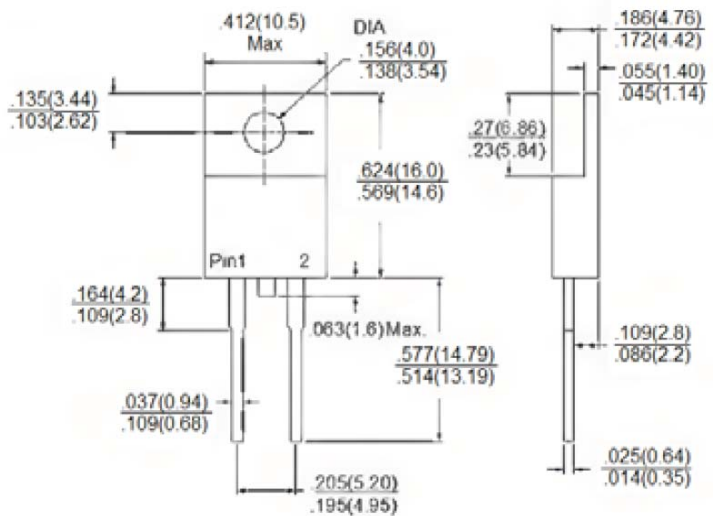

## Features

- High efficiency, Low VF
- High current capability
- High reliability
- High surge current capability
- For use in low voltage, high frequency inverter, free wheeling, and polarity protection application.
- Green compound with suffix "G" on packing code & prefix "G" on datecode

## Mechanical Data

- Case: TO-220AC molded plastic
- Epoxy: UL 94V-0 rate flame retardant
- Terminals: Pure tin plated leads, lead free, solderable per MIL-STD-202, Method 208 guaranteed
- Polarity: As marked
- High temperature soldering guaranteed: 260°C/10s/.25", (6.35mm) from case.
- Weight: 1.9 grams



## Dimensions in inches and (millimeters)

### Marking Diagram

- MUR8XX = Specific Device Code  
G = Green Compound  
Y = Year  
WW = Work Week

## Maximum Ratings and Electrical Characteristics

Rating at 25 °C ambient temperature unless otherwise specified.

Single phase, half wave, 60 Hz, resistive or inductive load.

For capacitive load, derate current by 20%

Type Number	Symbol	MUR820	MUR840	MUR860	Units
Maximum Repetitive Peak Reverse Voltage	$V_{RRM}$	200	400	600	V
Maximum RMS Voltage	$V_{RMS}$	140	280	420	V
Maximum DC Blocking Voltage	$V_{DC}$	200	400	600	V
Maximum Average Forward Rectified Current	$I_{F(AV)}$	8			A
Peak Forward Surge Current, 8.3 ms Single Half Sine-wave Superimposed on Rated Load (JEDEC method )	$I_{FSM}$	100			A
Maximum Instantaneous Forward Voltage (Note 1) @ 8 A	$V_F$	0.975	1.30	1.70	V
Maximum Reverse Current @ $T_A=25\text{ }^\circ\text{C}$ @ $T_A=100\text{ }^\circ\text{C}$	$I_R$	5 250			$\mu\text{A}$ $\mu\text{A}$
Maximum Reverse Recovery Time (Note 2)	$T_{rr}$	25	50		ns
Typical Thermal Resistance	$R_{\theta JC}$	3.0	2.0		$^\circ\text{C/W}$
Operating Temperature Range	$T_J$	-65 to + 175			$^\circ\text{C}$
Storage Temperature Range	$T_{STG}$	-65 to + 175			$^\circ\text{C}$

Note 1: Pulse test:  $t_p = 300\mu\text{s}$ , Duty Cycle < 1%

Note 2: Reverse Recovery Test Condition:  $I_F=0.5\text{A}$ ,  $I_R=1.0\text{A}$ ,  $I_{RR}=0.25\text{A}$

## RATINGS AND CHARACTERISTIC CURVES (MUR820 THRU MUR860)

FIG.1 MAXIMUM FORWARD CURRENT DERATING CURVE

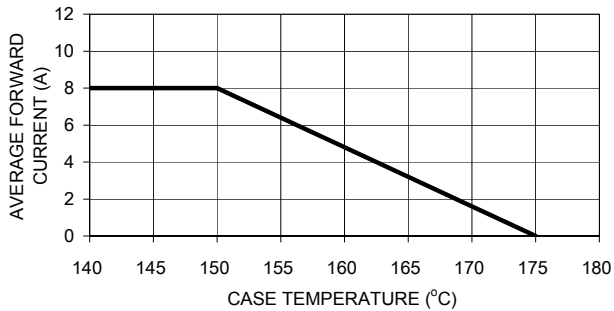

FIG. 2 MAXIMUM NON-REPETITIVE FORWARD SURGE CURRENT

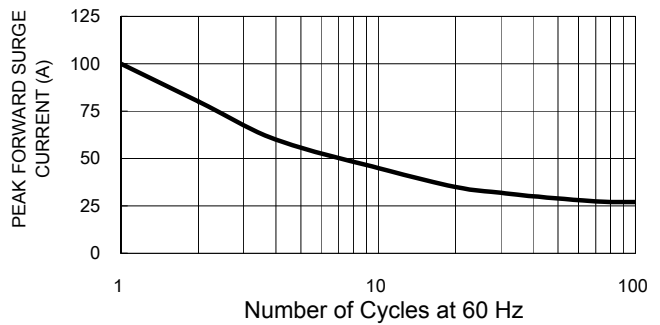

FIG. 3 TYPICAL INSTANTANEOUS FORWARD CHARACTERISTICS

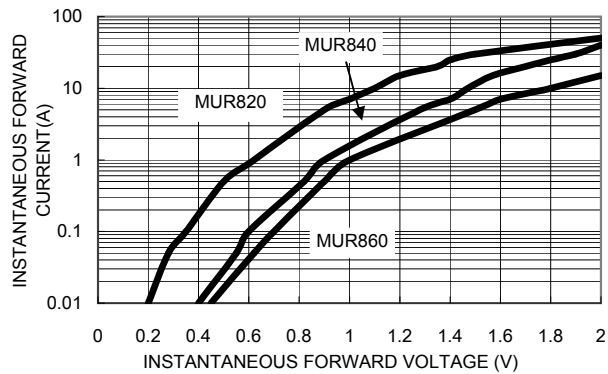

FIG. 4 TYPICAL REVERSE CHARACTERISTICS

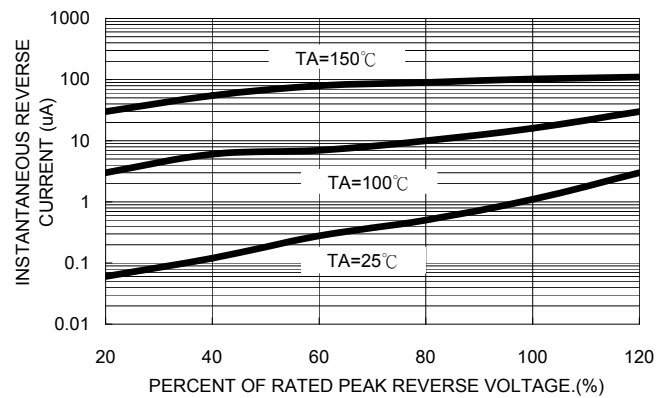

FIG. 5 TYPICAL JUNCTION CAPACITANCE

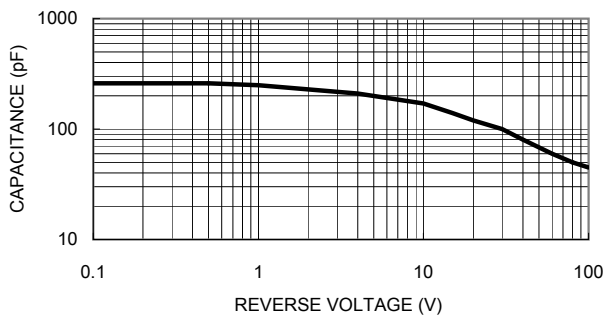

FIG.6- REVERSE RECOVERY TIME CHARACTERISTIC AND TEST CIRCUIT DIAGRAM

