



EN Operating instructions..... pages 1 to 6
Translation of the original operating instructions

FR Vous trouverez la version actuelle du mode d'emploi dans votre langue nationale officielle sur l'Internet, www.schmersal.net.

ES Encontrará el manual de instrucciones actual en su idioma oficial de la UE en nuestra página de Internet www.schmersal.net.

NL U vindt de huidige versie van de gebruikshandleiding in uw officiële landstaal op het Internet, www.schmersal.net.

IT Il manuale d'istruzioni aggiornato nella vostra lingua (lingua ufficiale UE) è scaricabile in Internet all'indirizzo www.schmersal.net.

JP EU公用語で書かれた最新の取扱説明書は、インターネット (www.schmersal.net) からダウンロードできます。

Content

1 About this document	
1.1 Function	1
1.2 Target group: authorised qualified personnel	1
1.3 Explanation of the symbols used	1
1.4 Appropriate use	1
1.5 General safety instructions	1
1.6 Warning about misuse	1
1.7 Exclusion of liability	1
2 Product description	
2.1 Ordering code	2
2.2 Special versions	2
2.3 Destination and use	2
2.4 Technical data	2
2.5 Safety classification	2
3 Mounting	
3.1 General mounting instructions	2
3.2 Dimensions	3
4 Electrical connection	
4.1 General information for electrical connection	3
4.2 Contact variants	4
5 Set-up and maintenance	
5.1 Functional testing	4
5.2 Maintenance	4
6 Disassembly and disposal	
6.1 Disassembly	
6.2 Disposal	
7 Appendix	
7.1 EC Declaration of conformity	

1 About this document

1.1 Function

This operating instructions manual provides all the information you need for the mounting, set-up and commissioning to ensure the safe operation and disassembly of the safety switchgear. The operating instructions must be available in a legible condition and a complete version in the vicinity of the device.

1.2 Target group: authorised qualified personnel

All operations described in this operating instructions manual must be carried out by trained specialist personnel, authorised by the plant operator only.

Please make sure that you have read and understood these operating instructions and that you know all applicable legislations regarding occupational safety and accident prevention prior to installation and putting the component into operation.

The machine builder must carefully select the harmonised standards to be complied with as well as other technical specifications for the selection, mounting and integration of the components.

1.3 Explanation of the symbols used



Information, hint, note:

This symbol is used for identifying useful additional information.



Caution: Failure to comply with this warning notice could lead to failures or malfunctions.

Warning: Failure to comply with this warning notice could lead to physical injury and/or damage to the machine.

1.4 Appropriate use

The ZQ 700 pull-wire emergency stop switch meets the requirements of EN ISO 13850, IEC/EN 60947-5-1 and IEC/EN 60947-6-5. Pull-wire emergency stop switches are used on machinery and plants, where triggering the emergency stop command must be enabled at arbitrary points on the wire run.

The safety switchgear must be exclusively used in accordance with the versions listed below or for the applications authorised by the manufacturer. Detailed information regarding the range of applications can be found in the chapter "Product description".

1.5 General safety instructions

The user must observe the safety instructions in this operating instructions manual, the country-specific installation standards as well as all prevailing safety regulations and accident prevention rules.



Further technical information can be found in the Schmersal catalogues or in the online catalogue on the Internet: www.schmersal.net.

The information contained in this operating instructions manual is provided without liability. Subject to technical modifications.

There are no residual risks, provided that the safety instructions as well as the instructions regarding mounting, commissioning, operation and maintenance are observed.

1.6 Warning about misuse



In case of inadequate or improper use or manipulations of the safety switchgear, personal hazards or damage to machinery or plant components cannot be excluded. The relevant requirements of the standard EN 1088 must be observed.

1.7 Exclusion of liability

We shall accept no liability for damages and malfunctions resulting from defective mounting or failure to comply with this operating instructions manual. The manufacturer shall accept no liability for damages resulting from the use of unauthorised spare parts or accessories.

For safety reasons, invasive work on the device as well as arbitrary repairs, conversions and modifications to the device are strictly forbidden; the manufacturer shall accept no liability for damages resulting from such invasive work, arbitrary repairs, conversions and/or modifications to the device.

2 Product description

2.1 Ordering code

This operating instructions manual applies to the following types:

ZQ 700-①

No.	Option	Description
①	11	1 NO/1 NC
	02	2 NC contacts



Only if the information described in this operating instructions manual are realised correctly, the safety function and therefore the compliance with the Machinery Directive is maintained.

2.2 Special versions

For special versions, which are not listed in the order code below 2.1, these specifications apply accordingly, provided that they correspond to the standard version.

2.3 Destination and use

If the tensioned pull-wire is pulled or in case of wire breakage, the switching function of the pull-wire switch is activated. (refer to image 1).

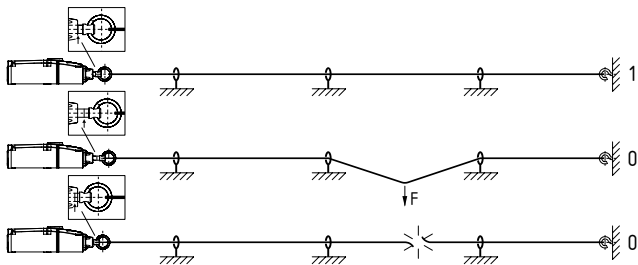

Image 1: position indication and actuation

Design/operating principle

The pull-wire emergency stop switches of the ZQ 700 series are brought into the operational condition by the proper pre-tensioning of a maximum 10 m long wire. The inner switching element has 2 contacts; in tensioned condition, the NC contacts are closed and the NO contacts are open

After actuation of the switching function, a latching mechanism maintains the stop command until the switch is released by pushing the blue reset button.

Prior to the reset of the stop signal, the reason why the switch has been actuated must be determined. The switch can only be reset if the switch is correctly pre-tensioned (position indication in central position, refer to image 1).

2.4 Technical data

Standards:	IEC/EN 60947-5-1, IEC/EN 60947-5-5, EN ISO 13850, NBR 13930
Enclosure:	thermoplastic
Cover:	thermoplastic
Protection class:	IP 67 to IEC/EN 60529
Contact material:	Silver
Switching system:	Change-over contact with double break, 1 to 2 NC contacts
	Snap action with positive break NC contacts
Termination:	Screw terminals
Cable section:	max. 2.5 mm ² (incl. conductor ferrules)
Cable entry:	1 x M20 x 1.5
U _{imp} :	6 kV
U _i :	500 V
I _{the} :	10 A
I _e /U _e :	4 A/230 VAC, 2,5 A/400 VAC, 1 A/500 VAC, 1 A/24 VDC
Utilisation category:	AC-15, DC-13
Max. fuse rating:	6 A gG D-fuse (DIN EN 60269-1)
Ambient temperature:	- 25 °C ... + 70 °C
Relative humidity:	30...95%, no condensation, no icing
Wire length:	max. 10 m
	(Please observe the ambient temperature range and the wire supports!)
Mechanical life:	>1 million operations
Max. actuating force:	200 N
Max. actuating travel:	400 mm

2.5 Safety classification

Standards:	EN ISO 13849-1
B _{10d} (NC contact):	100,000
Service life:	20 years

$$MTTF_d = \frac{B_{10d}}{0,1 \times n_{op}} \quad n_{op} = \frac{d_{op} \times h_{op} \times 3600 \text{ s/h}}{t_{cycle}}$$

(Specifications can vary depending on the application-specific parameters h_{op} , d_{op} and t_{cycle} as well as the load.)

3 Mounting

3.1 General mounting instructions

The mounting may only be carried out by authorised personnel. The pull-wire emergency stop switch is fitted by means of four screws (drilling distance 30 mm or 60 mm), at any place where a manual hazard-free release is possible. The device must be arranged so that the entire length of the wire can be viewed when standing at the switch.

In accordance with IEC/EN 90947-5-5, the maximum perpendicular traction force to be exercised on the wire in order to activate the emergency pull-wire switch is 200 N, the maximum deflection is 400 mm. Sufficient space must be provided so that the required actuating deflection can be reached.



To ensure an optimal operational reliability and to reduce the mounting time, the use of the pull-wire and combined fixing and tensioning system from Schmersal is recommended. Alternative, wire thimbles and clamps can be used in combination with a tensioner. In this case, the red PVC sheet must be removed in the clamping area prior to installing the wire.

For tensioned span lengths up to 10 m, intermediate wire supports are required every 2 to 5 m. To avoid resonance vibrations in the wire on machines with high vibrations, it is recommended to realise the individual support length differently. Assembly: refer to image 2.

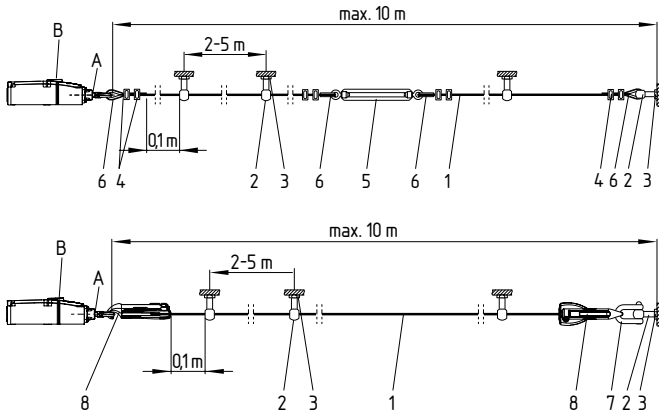

Image 2: mounting of the components

- 1 pull-wire with red PVC sheath Ø 5 mm (steel core: Ø 3 mm)
- 2 eyebolt
- 3 nut
- 4 wire clamp
- 5 tensioner
- 6 wire thimble
- 7 shackle
- 8 S 900 wire tensioner
- A position indication
- B Reset button

Due to the thermal expansion behaviour of the wire, the maximum authorised wire length is determined by the ambient temperature range (refer to image 3).

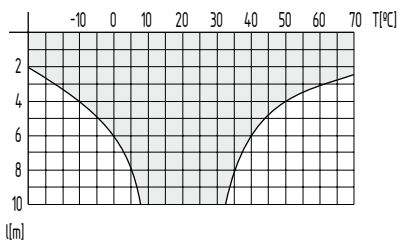

Image 3: temperature-dependent maximum wire length

The pull-wire must be fixed to the ring and then be pre-tensioned until the position indication is in central position (refer to image 1).

As the thimbles are subject to deformation in case of wire pull, the wire should be firmly pulled several times after installation. After that, the wire must be re-tensioned (refer to image 4).

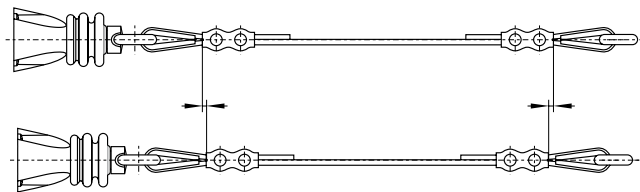

Image 4: deformation of the wire thimbles



To ensure an optimal operational reliability and to reduce the mounting time, the use of the pull-wire and combined fixing and tensioning system from Schmersal is recommended. Alternative, wire thimbles and clamps can be used in combination with a tensioner. In this case, the red PVC sheet must be removed in the clamping area prior to installing the wire.

3.2 Dimensions

All measurements in mm.

ZQ 700

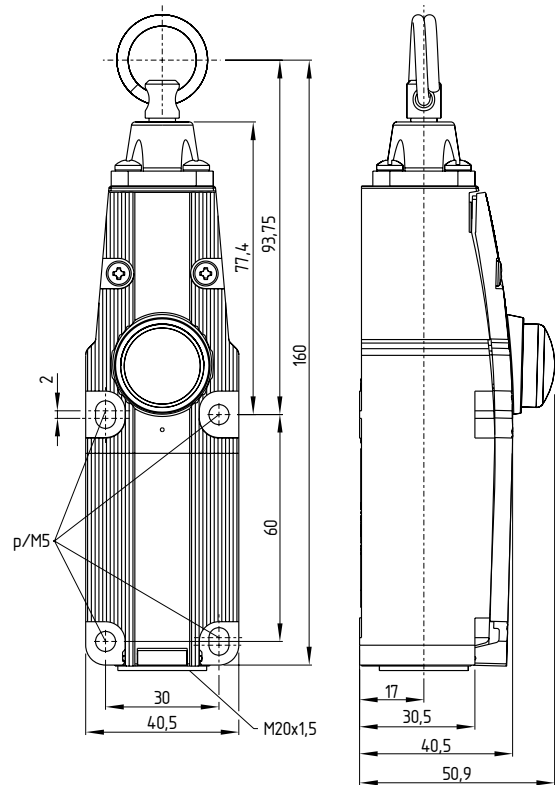

- Legend:
- A position indication
 - B Reset buttons

4 Electrical connection

4.1 General information for electrical connection



The electrical connection may only be carried out by authorised personnel in a de-energised condition.

For the cable entry, suitable M20 x 1.5 cable glands with an appropriate degree of protection must be used. To open the cover, the cover screws must be loosened. When wiring, please ensure that no cables are located within the range of the lever system and the pushbutton. After wiring, the inside of the switch must imperatively be cleaned (e.g. removal of cables residues), considering that foreign bodies can affect the switching behaviour. Screw back the cover after that and uniformly tighten the cover screws.

4.2 Contact variants

ZQ 700-11

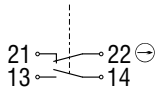

ZQ 700-02

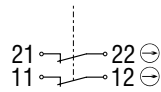

Legend: A Positive break NC contact

5 Set-up and maintenance

5.1 Functional testing

The safety function of the safety components must be tested. The following conditions must be previously checked and met:

1. Check the proper fitting of the pull-wire emergency stop switch
2. Check the integrity of the cable entry and connections
3. Check the switch enclosure for damage.
4. Check the functioning of the switch by actuating the wire
5. Check the cable tensioning by means of the position indicator

5.2 Maintenance

A regular visual inspection and functional test, including the following steps, is recommended:

1. Check the functioning of the switch by actuating the wire
2. Check the cable entries and the wire connections
3. Remove particles of dust and soiling
4. Check the wire tension through the wire position indication and check the wire and the wire guides for damages and proper fitting

Damaged or defective components must be replaced.

6 Disassembly and disposal



6.1 Disassembly

The safety switchgear must be disassembled in a de-energised condition only.

6.2 Disposal

The safety switchgear must be disposed of in an appropriate manner in accordance with the national prescriptions and legislations.

7.1 EC Declaration of conformity

	
<h2>EC Declaration of conformity</h2> <hr/>	
Translation of the original operating instructions valid as of December 29, 2009	ACE Schmersal Eletroeletrônica Industrial Ltda. Rodovia Boituva-Porto Feliz, Km 12 Vila Esplanada CEP: 18550-000 Boituva – SP Brazil Internet: www.schmersal.com.br
We hereby certify that the hereafter described safety components both in its basic design and construction conforms to the applicable European Directives.	
Name of the safety component:	ZQ 700
Description of the safety component:	Pull-wire emergency stop switch for safety applications.
Harmonised EC-Directives:	2006/42/EC EC-Machinery Directive
Person authorized for the compilation of the technical documentation:	Ulrich Loss Mödinghofe 30 42279 Wuppertal
Place and date of issue:	Boituva, October 26, 2009
	
	Authorised signature Luis F. M. Stumpf Construction & Development Department Chief



Note
The currently valid declaration of conformity can be downloaded from the internet at www.schmersal.net.



K. A. Schmersal GmbH
Industrielle Sicherheitssysteme
Möddinghofe 30, D - 42279 Wuppertal
Postfach 24 02 63, D - 42232 Wuppertal

Telefon +49 - (0)2 02 - 64 74 - 0
Telefax +49 - (0)2 02 - 64 74 - 1 00
E-Mail: info@schmersal.com
Internet: <http://www.schmersal.com>

Production site:
ACE Schmersal
Eletrônica Industrial Ltda.
Rodovia Boituva-Porto Feliz, Km 12
Vila Esplanada-CEP: 18550-000, Boituva-SP
Brazil
Telefon: +55 - (0)15 - 32 63 - 9866
Telefax +55 - (0)15 - 32 63 - 9890
E-Mail: export@schmersal.com.br
Internet: <http://www.schmersal.com.br>