

TEST/CHARACTERISTICS	STANDARD REFERENCE	VALUES/REMARKS		
----------------------	--------------------	----------------	--	--

ELECTRICAL CHARACTERISTICS

Impedance		50 Ω		
Frequency range		DC-4 GHz		
Typical V.S.W.R. <i>Straight models cable group : 2/50, 2.6/50, 5/50, 10 + 11/50, .141"</i> <i>Right angle models 2/50, 2.6/50, 5/50,</i>		1 GHz 1.12	2.5 GHz 1.18 1.30 max	4 GHz 1.22
Insertion loss <i>straight connector</i> <i>right-angle connector</i>		0.05 0.08	0.07 0.16	0.13 0.20
RF Leakage		- 55 dB min from 2 to 3 GHz		
Insulation resistance		5000 MΩ min	5000 MΩ min	5000 MΩ min
Contact resistance <i>center contact</i> <i>outer contact</i>	MIL	1.5 mΩ 0.2 mΩ		
Working voltage in VRMS <i>at sea level</i> <i>(at 21 000m)</i>		500 125		
Dielectric withstanding voltage in VRMS <i>at sea level</i> <i>(at 21 000m)</i>		1500 375		
RF testing voltage in VRMS <i>sea level (5 MHz)</i>		1000		

MECHANICAL CHARACTERISTICS

Durability		500 matings		
Force to engage and disengage <i>axial torque</i>		13.6 N max 28.6 Ncm		
Coupling nut retention force	MIL	445 N		
Cable retention force <i>cable 2/50, 2.6/50</i> <i>cable 5/50, 10 + 11/50</i> <i>cable .141"</i>		227 N		
Center contact retention force		27.2 N		

ENVIRONMENTAL CHARACTERISTICS

Temperature range <i>flexible cables</i> <i>semi-rigid cables</i>	MIL	- 65°C + 165°C - 65°C + 105°C		
Thermo cycling test		MIL STD 202, method 107, condition B		
Thermal shock		MIL STD 202, method 107, condition B		
Hight temperature endurance		MIL STD 202, method 108		
Corrosion salt spray		MIL STD 202, method 101, condition B		
Vibration		MIL STD 202, method 204, condition B		
Shock		MIL STD 202, method 213, condition G		
Moisture resistance		MIL STD 202, method 106		
Hermetic test		MIL STD 202, method 112, condition C vacuum 10 ⁻⁶ Hgmm (Torr) leakage rate < 10 ⁻⁶ atm/cm ³ /s		
Barometric pressure		Pressure test : 3.5 bars; duration : 2 mn; temperature : 15° C to 25 °C		

BNC 50 Ω

CHARACTERISTICS

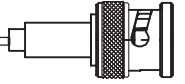

MATERIALS

Bodies		Brass
Center contact	<i>male</i> <i>female</i>	Brass Bronze or heat treated beryllium following QQ-C-530
Nut		Brass
Insulator		PTFE
Gasket		Silicon rubber

PLATINGS

Bodies		Nickel
Center contacts		Gold

POWER RATING

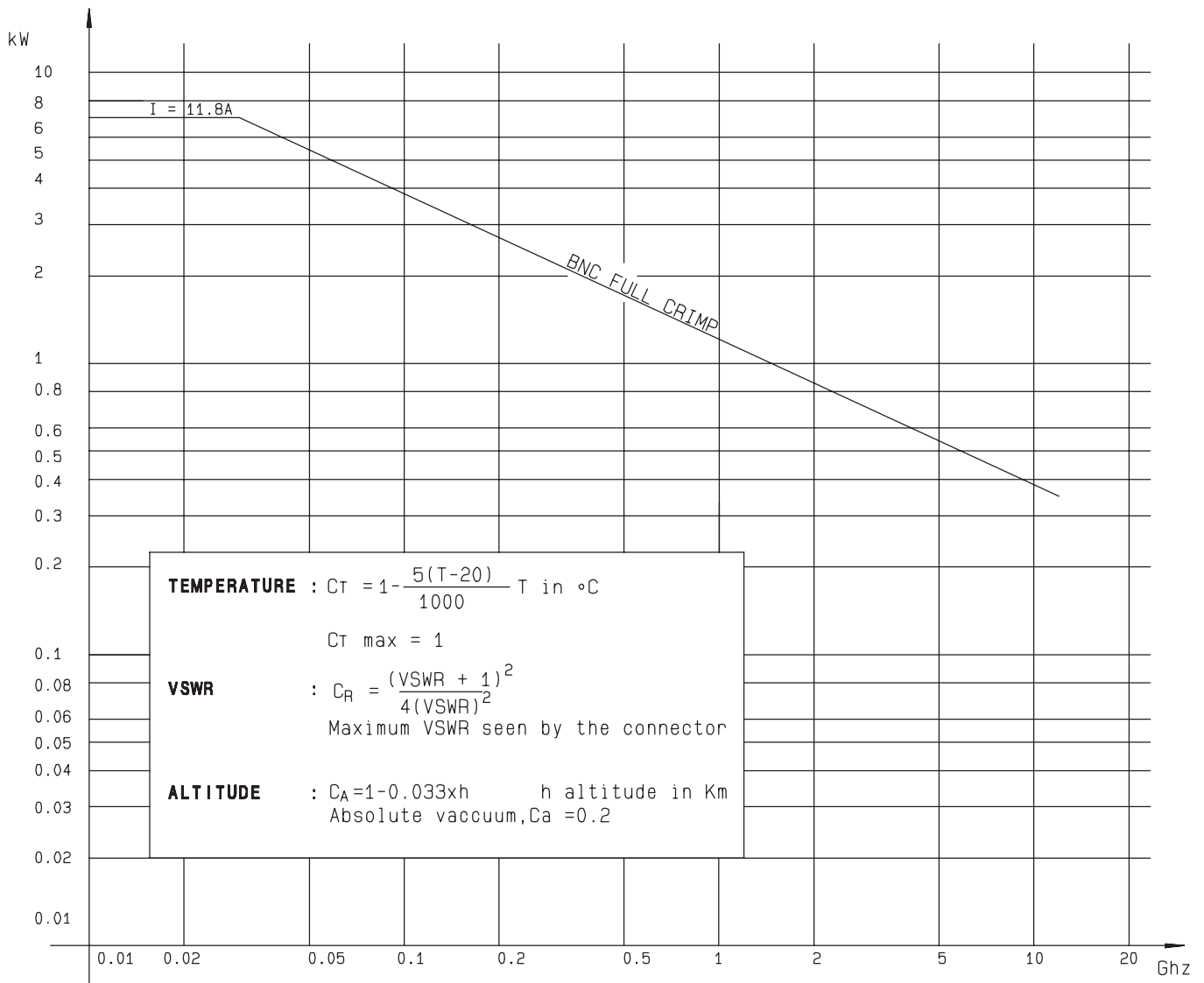

Standard packaging : unit

All dimensions are given in mm.

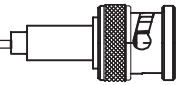

STRAIGHT BULKHEAD RECEPTACLES WITH SOLDER POT

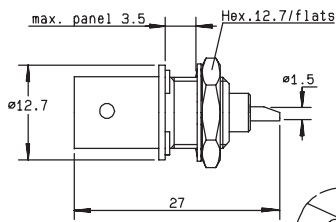

Fig. 1

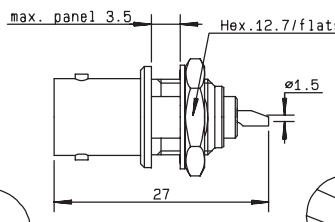

Fig. 2

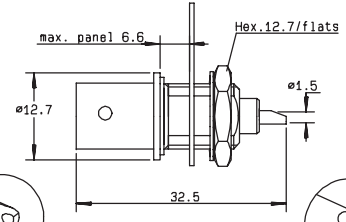

Fig. 3

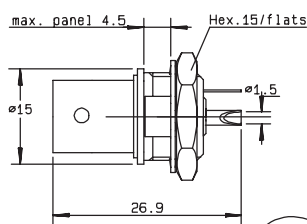

Fig. 4

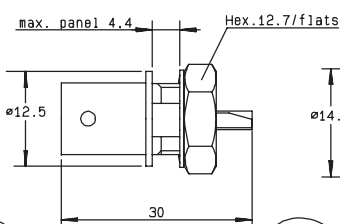

Fig. 5

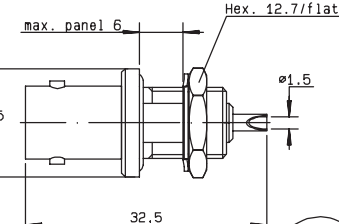

Fig. 6

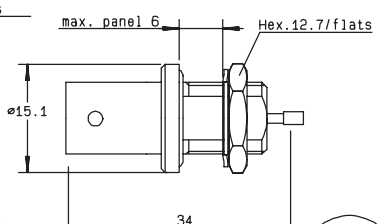
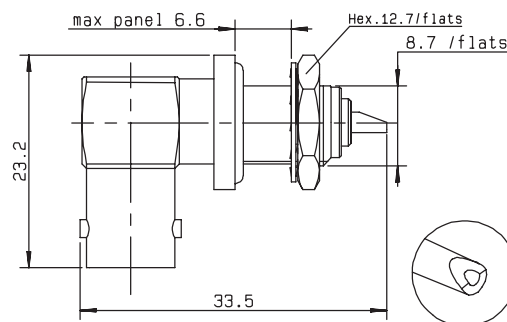

Fig. 7

part number	fig.	captive center contact	cut out	note
R141 554 000	1	yes	P20	
R141 557 000*	2	yes	P07	
R141 559 000	3	yes	P07	solder tag
R141 572 000*	4	yes	P05	insulated receptacle + solder tag
R141 574 000	5	yes	P07	insulated receptacle + solder tag
R141 603 000	6	yes	P22	fully sealed/Q200-5 insulator
R141 605 000	6	yes	P22	fully sealed
R141 625 000	7	yes	P07	hermetically sealed

RIGHT ANGLE BULKHEAD RECEPTACLE WITH SOLDER POT



part number	captive center contact	cut out
R141 680 000	yes	P07

* Packaging = 100 pieces.

