

Mechanical features

Weight g 220

UL technical data

Rated operational voltage AC (UL) V 600

Dimensions

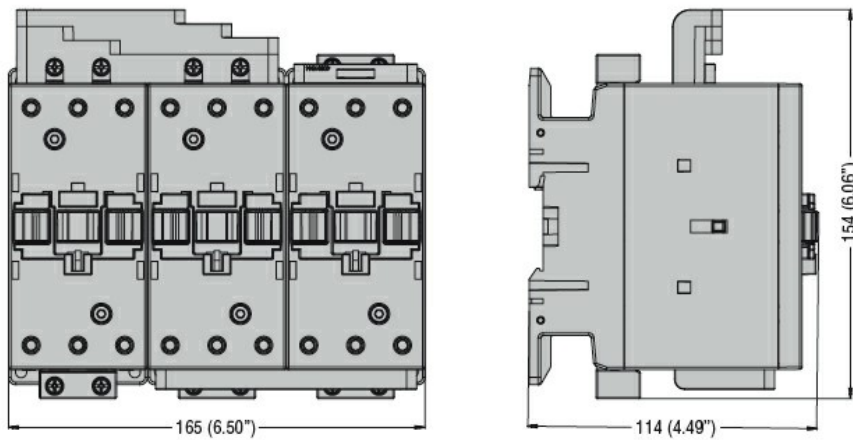

Wiring diagrams

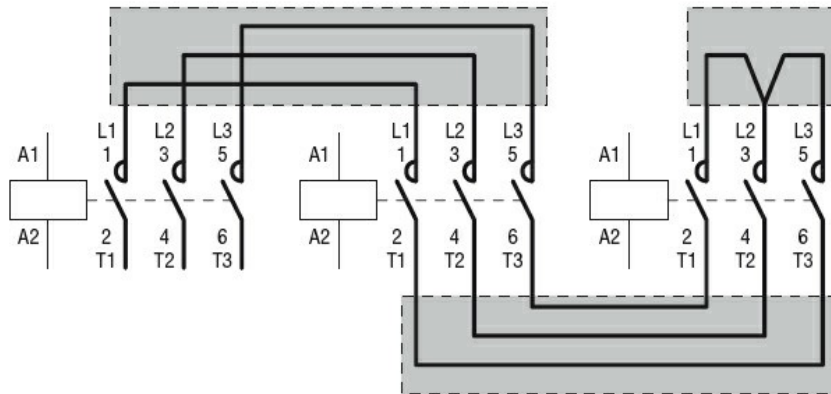

Certifications and compliance

Compliance

CSA C22.2 n° 60947-1
IEC/EN 60947-1
UL 60947-1

Certificates

cULus
EAC

ETIM classification

ETIM 8.0

EC002498 -
Accessories/spare
parts for low-
voltage switch
technology