



FPF2223-FPF2225

Integrated Load Switch with Adjustable High Precision Current Limit

Features

- 1.8 to 5.5V Input Voltage Range
- Typical $R_{DS(ON)} = 140m\Omega @ V_{IN} = 5.5V$
- Typical $R_{DS(ON)} = 160m\Omega @ V_{IN} = 3.3V$
- 250-625mA (min) Adjustable Current Limit
- 5% Current Limit Tolerance @ 625mA (min)
- 72 Ω (typ) Output Discharge Resistance
- ESD Protected, Above 8kV HBM and 2kV CDM

Applications

- PDAs
- Cell Phones
- GPS Devices
- MP3 Players
- Digital Cameras
- Peripheral Ports
- Notebook Computer

General Description

The FPF2223-FPF2225 are low $R_{DS(ON)}$ P-Channel MOSFET load switches with high precision current limit value. The input voltage range operates from 1.8V to 5.5V to fulfill today's Ultra Portable Device's supply requirement. Switch control is by a logic input (ON) capable of interfacing directly with low voltage control signal. On-chip pull-down is available for output quick discharge when switch is turned off.

For the FPF2224, if the constant current condition still persists after 30ms, these parts will shut off the switch and pull the fault signal pin (FLAGB) low. The FPF2223 has an auto-restart feature, which will turn the switch on again after 450ms if the ON pin is still active. The FPF2224 do not have this auto-restart feature so the switch will remain off until the ON pin is cycled. For the FPF2225, a current limit condition will immediately pull the fault signal pin low and the part will remain in the constant-current mode until the switch current falls below the current limit. For the FPF2223 through FPF2225, the current limit is set by an external resistor and the minimum current limit is 250mA.

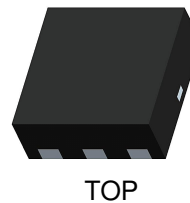
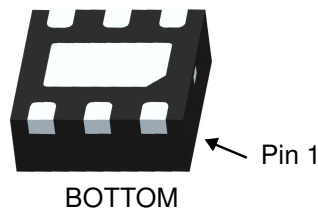

Ordering Information

| Part | Current Limit (mA) | Current Limit Blanking Time (mS) | Auto-Restart Time (mS) | ON Pin Activity |
|---------|--------------------|----------------------------------|------------------------|-----------------|
| FPF2223 | 250-625 | 30 | 450 | Active HI |
| FPF2224 | 250-625 | 30 | NA | Active HI |
| FPF2225 | 250-625 | NA | NA | Active HI |

Typical Application Circuit

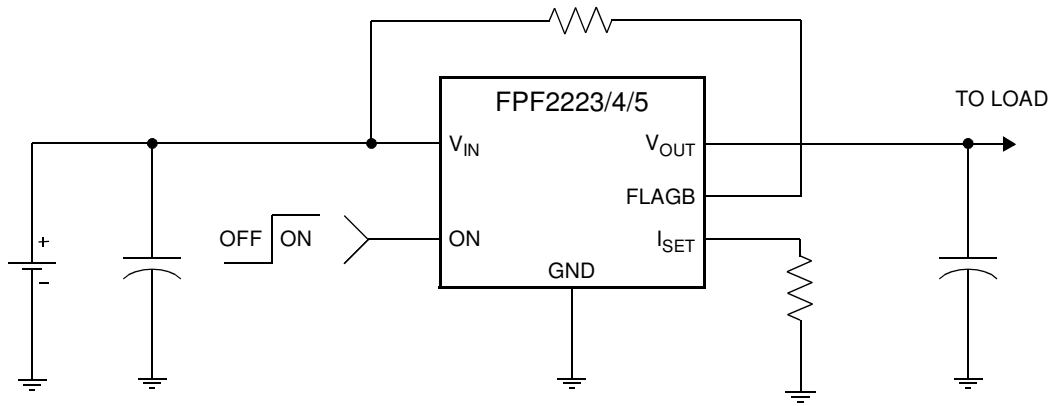

Functional Block Diagram

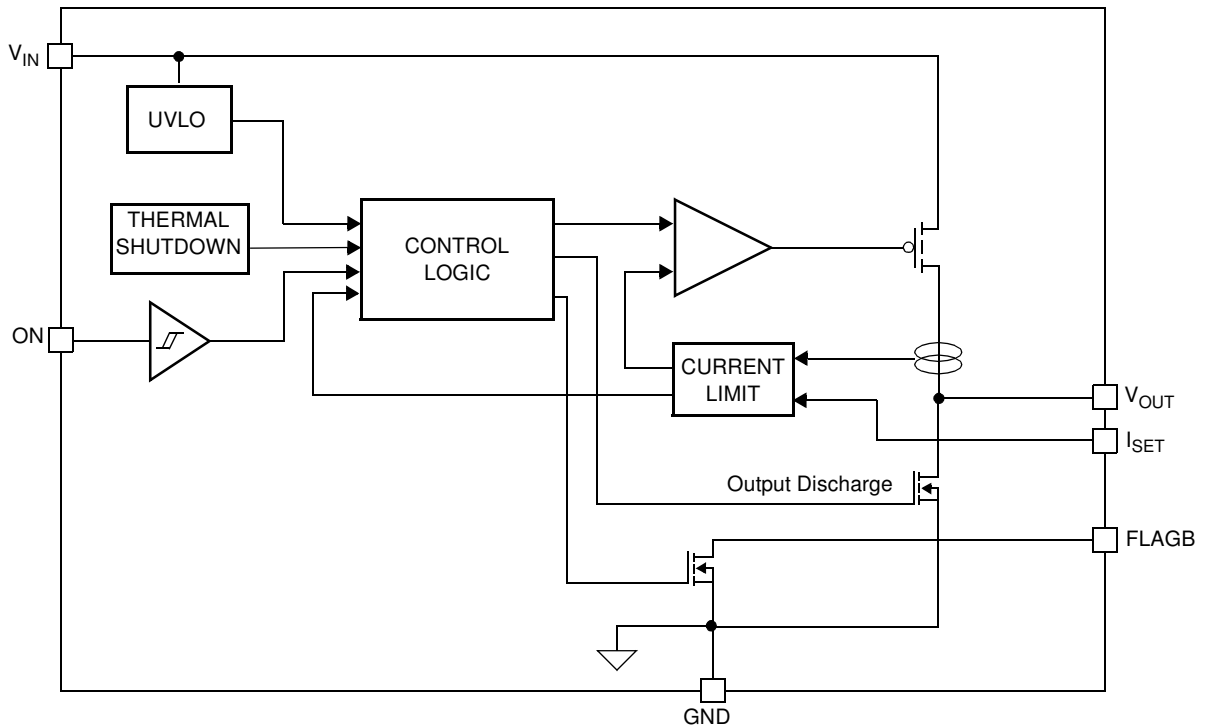

Pin Configuration

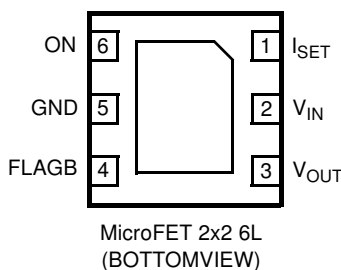

Pin Description

| Pin | Name | Function |
|-----|-----------|--|
| 1 | I_{SET} | Current Limit Set Input : A resistor from I_{SET} to ground sets the current limit for the switch |
| 2 | V_{IN} | Supply Input: Input to the power switch and the supply voltage for the IC |
| 3 | V_{OUT} | Switch Output: Output of the power switch |
| 4 | FLAGB | Fault Output: Active LO, open drain output which indicates an over current, supply under voltage or over temperature state |
| 5 | GND | Ground |
| 6 | ON | ON/OFF Control Input |

Absolute Maximum Ratings

| Parameter | Min. | Max. | Unit |
|--|------|------|---------------------------|
| V_{IN} , V_{OUT} , ON, FLAGB TO GND | -0.3 | 6 | V |
| I_{SET} TO GND | -0.3 | 0.3 | V |
| Power Dissipation @ $T_A = 25^\circ\text{C}$ | | 1.2 | W |
| Operating and Storage Junction Temperature | -65 | 125 | $^\circ\text{C}$ |
| Thermal Resistance, Junction to Ambient | | 86 | $^\circ\text{C}/\text{W}$ |
| Electrostatic Discharge Protection | HBM | 8000 | V |
| | MM | 400 | V |
| | CDM | 2000 | V |

Recommended Operating Range

| Parameter | Min. | Max. | Unit |
|--------------------------------------|------|------|------------------|
| V_{IN} | 1.8 | 5.5 | V |
| Ambient Operating Temperature, T_A | -40 | 85 | $^\circ\text{C}$ |

Electrical Characteristics

$V_{IN} = 1.8$ to 5.5V , $T_A = -40$ to $+85^\circ\text{C}$ unless otherwise noted. Typical values are at $V_{IN} = 3.3\text{V}$ and $T_A = 25^\circ\text{C}$.

| Parameter | Symbol | Conditions | Min. | Typ. | Max. | Units |
|---------------------------|----------|---|------|------|------|---------------|
| Basic Operation | | | | | | |
| Operating Voltage | V_{IN} | | 1.8 | | 5.5 | V |
| Quiescent Current | I_Q | $I_{OUT}=0\text{mA}$, $V_{IN}=V_{ON}=1.8\text{V}$, $R_{SET}=36\text{K}$ | | 45 | 75 | μA |
| | | $I_{OUT}=0\text{mA}$, $V_{IN}=V_{ON}=3.3\text{V}$, $R_{SET}=36\text{K}$ | | 50 | 80 | |
| | | $I_{OUT}=0\text{mA}$, $V_{IN}=V_{ON}=5.5\text{V}$, $R_{SET}=36\text{K}$ | | 55 | 95 | |
| V_{IN} Shutdown Current | | $V_{ON}=0\text{V}$, $V_{IN}=5.5\text{V}$, $V_{OUT}=\text{short to GND}$ | | | 2.5 | μA |

| Parameter | Symbol | Conditions | Min. | Typ. | Max. | Units |
|-----------------------------------|-----------------|--|------|------|------|-------|
| V _{OUT} Shutdown Current | | V _{ON} =0V, V _{OUT} =5.5V, V _{IN} =short to GND | | | 1 | μA |
| On-Resistance | R _{ON} | V _{IN} =5.5V, I _{OUT} =200mA, T _A =25°C | | 140 | 185 | mΩ |
| | | V _{IN} =3.3V, I _{OUT} =200mA, T _A =25°C | | 160 | 210 | |
| | | V _{IN} =1.8V, I _{OUT} =200mA, T _A =25°C | | 230 | 300 | |
| | | V _{IN} =3.3V, I _{OUT} =200mA, T _A =-40 to +80°C | 90 | | 265 | |
| Output Discharge Resistance | | V _{IN} =3.3V, V _{ON} =0V, I _{OUT} =10mA | | 72 | 105 | Ω |
| ON Input Logic High Voltage (ON) | V _{IH} | V _{IN} =1.8V | 0.8 | | | V |
| | | V _{IN} =5.5V | 1.4 | | | |
| ON Input Logic Low Voltage (OFF) | V _{IL} | V _{IN} =1.8V | | | 0.5 | V |
| | | V _{IN} =5.5V | | | 1.0 | |
| On Input Leakage | | V _{ON} = V _{IN} or GND | -1 | | 1 | μA |
| FLAGB Output Logic Low Voltage | | V _{IN} =5.5V, I _{SINK} =100μA | | 0.05 | 0.1 | V |
| | | V _{IN} =1.8V, I _{SINK} =100μA | | 0.12 | 0.25 | |
| FLAGB Output High Leakage Current | | V _{IN} =5.5V, Switch on | | | 1 | uA |

| Protections | | | | | | |
|-----------------------------------|--------------------|---|------|------|------|----|
| Current Limit | I _{LIM} | V _{IN} =3.3V, V _{OUT} = 3.0V, RSET=36K, T _A =25°C | 627 | 660 | 693 | mA |
| Thermal Shutdown | | Shutdown Threshold | | 140 | | °C |
| | | Return from Shutdown | | 130 | | |
| | | Hysteresis | | 10 | | |
| Under Voltage Shutdown | UVLO | V _{IN} increasing | 1.55 | 1.65 | 1.75 | V |
| Under Voltage Shutdown Hysteresis | | | | 50 | | mV |
| Dynamic | | | | | | |
| Turn On Time | t _{ON} | R _L =500Ω, C _L =0.001μF | | 70 | | μS |
| Turn Off Time | t _{OFF} | R _L =500Ω, C _L =0.001μF | | 600 | | nS |
| V _{OUT} Rise Time | t _{RISE} | R _L =500Ω, C _L =0.001μF | | 40 | | μS |
| V _{OUT} Fall Time | t _{FALL} | R _L =500Ω, C _L =0.001μF | | 100 | | nS |
| Over Current Blanking Time | t _{BLANK} | FPF2223, FPF2224 | 15 | 30 | 60 | mS |
| Auto-Restart Time | t _{RSTRT} | FPF2223 | 225 | 450 | 900 | mS |
| Current Limit Response Time | | V _{IN} = V _{ON} = 3.3V. Over-Current Condition: R _{LOAD} =V _{IN} /(I _{LIM} ×4) | | 5 | | μS |

Typical Characteristics

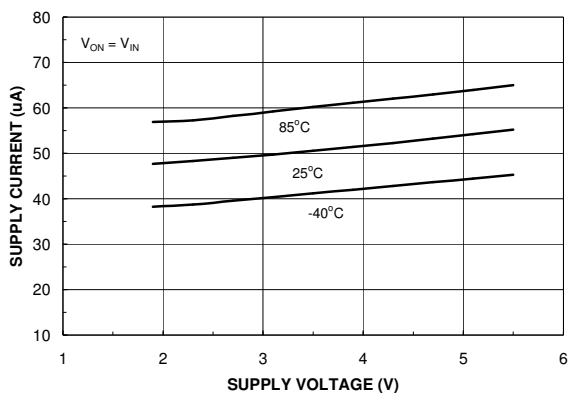

Figure 1. Quiescent Current vs. Input Voltage

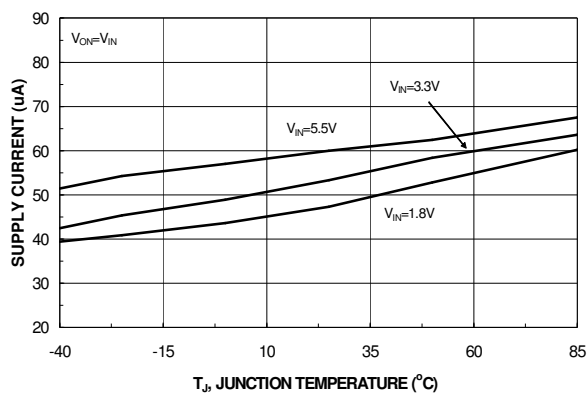

Figure 2. Quiescent Current vs. Temperature

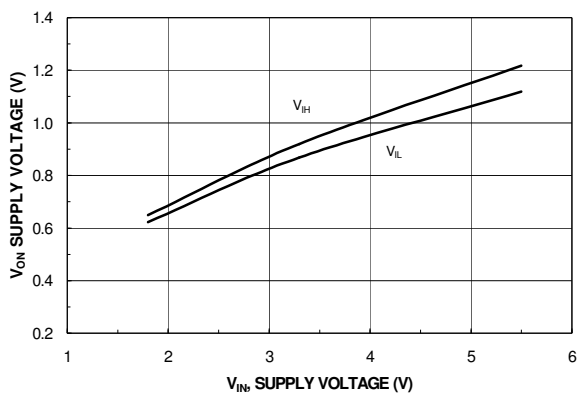

Figure 3. V_{ON} vs. Input Voltage

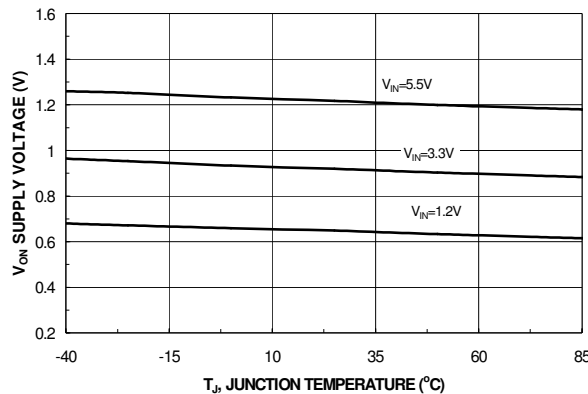

Figure 4. V_{ON} High Voltage vs. Temperature

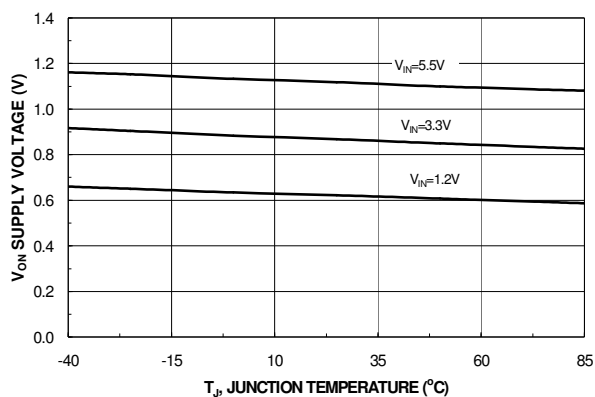

Figure 5. V_{ON} Low Voltage vs. Temperature

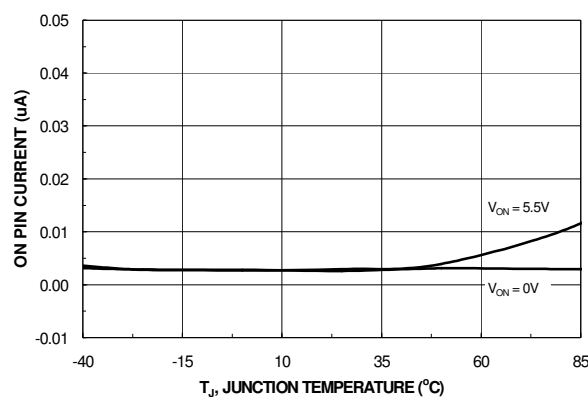

Figure 6. On Pin Current vs. Temperature

Typical Characteristics

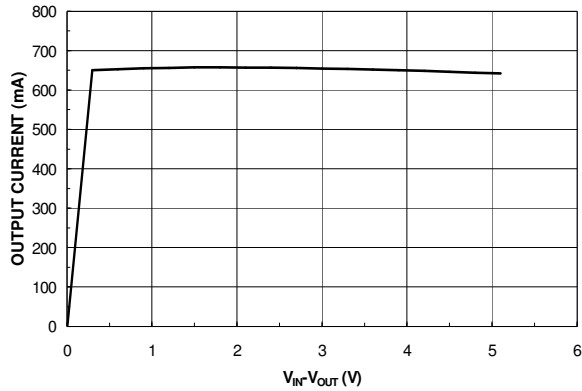

Figure 7. Current Limit vs. Output Voltage

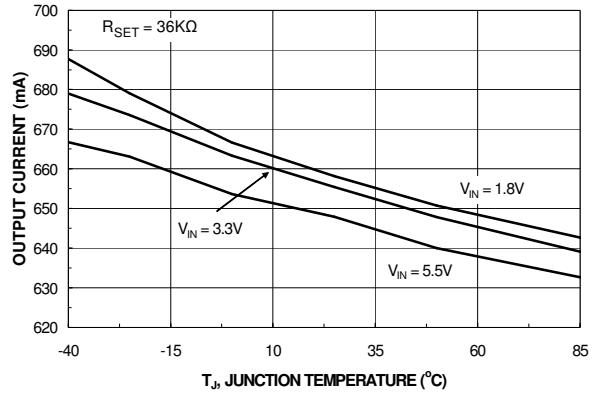

Figure 8. Current Limit vs. Temperature

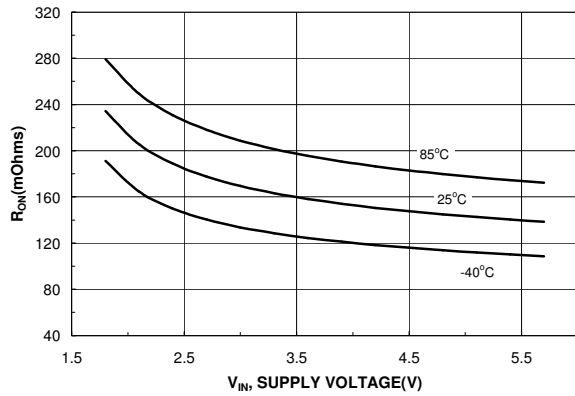

Figure 9. R_{ON} vs. Input Voltage

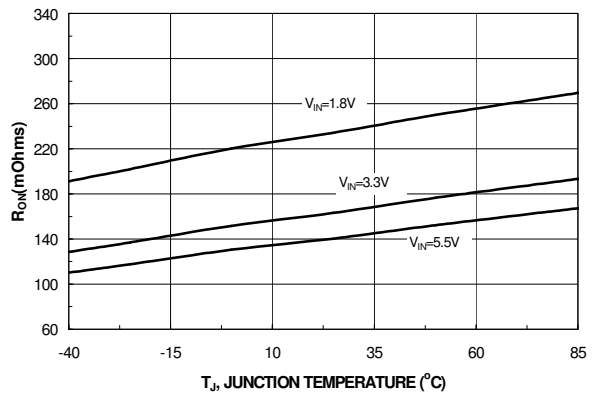

Figure 10. R_{ON} vs. Temperature

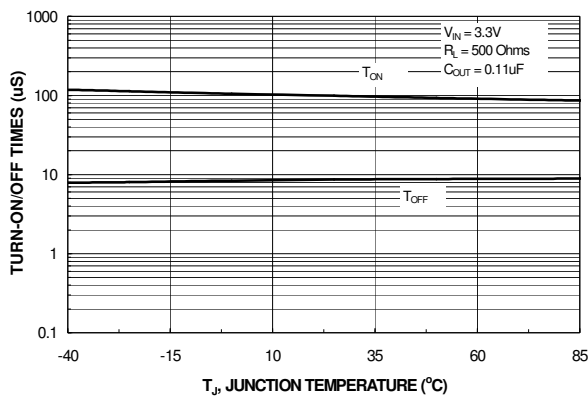

Figure 11. T_{OFF} / T_{ON} vs. Temperature

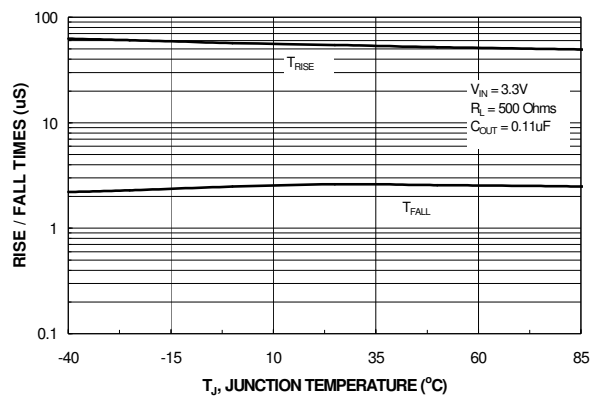

Figure 12. T_{RISE} / T_{FALL} vs. Temperature

Typical Characteristics

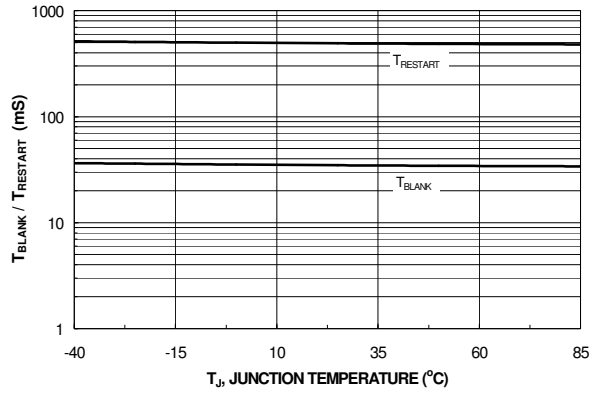

Figure 13. T_{BLANK} vs Temperature

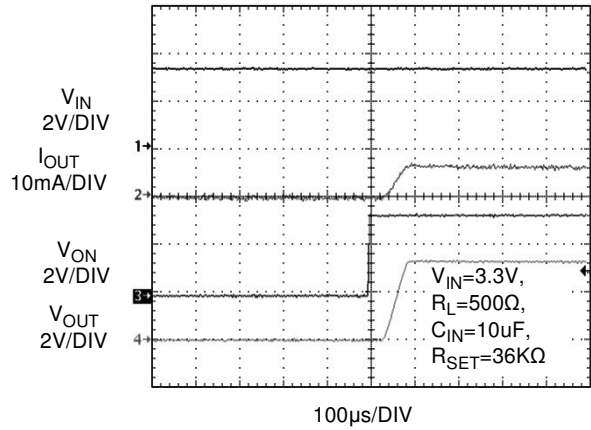

Figure 14. Turn On Response

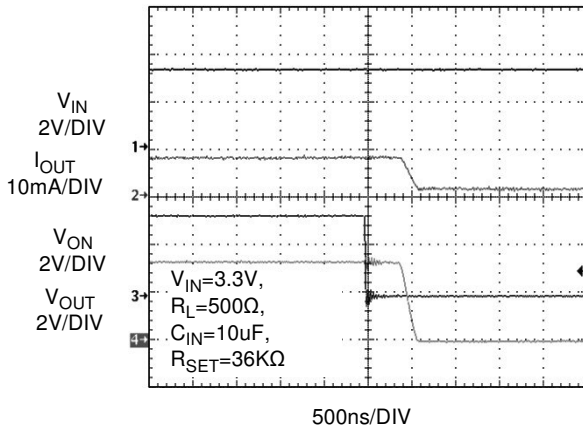

Figure 15. Turn Off Response

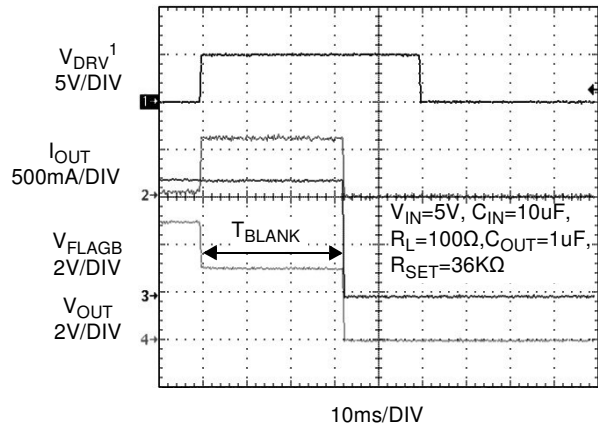

Figure 16. T_{BLANK} Response

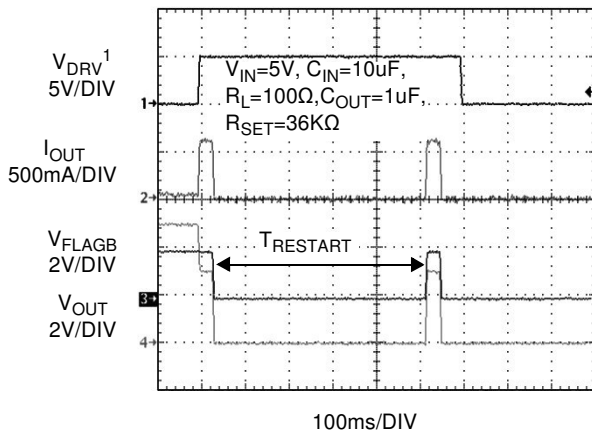

Figure 17. $T_{RESTART}$ Response

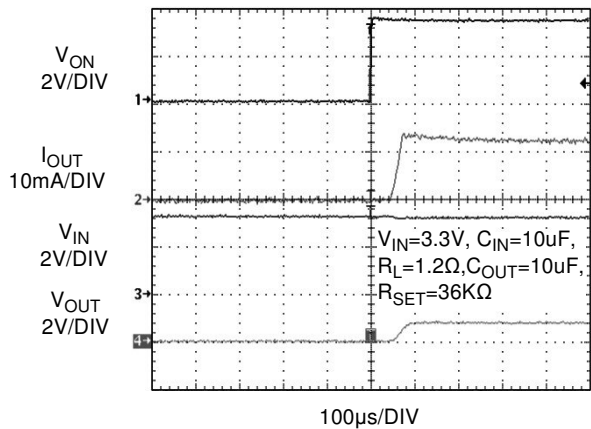

Figure 18. Current Limit Response
(Output is loaded with 1.2Ω resistor and $C_{OUT}=10\mu F$)

Note1: V_{DRV1} signal drives the gate of a NMOS transistor. The NMOS transistor is in series with a 5Ω resistor and is connected to the output of device. By turning on the transistor, the 5Ω resistor is loaded to the output and forces the device to go into overcurrent condition.

Typical Characteristics

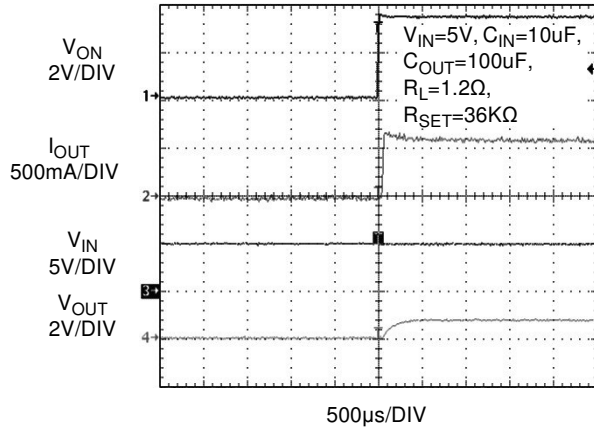

Figure 19. Current Limit Response
(Output is loaded with 1.2Ω resistor and $C_{OUT}=100\mu F$)

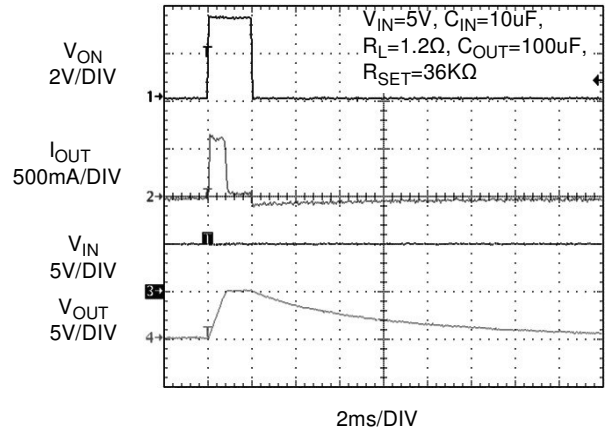

Figure 20. Current Limit and Output Discharge Response
(Device turns on and off into large capacitive load $C_{OUT}=100F$)

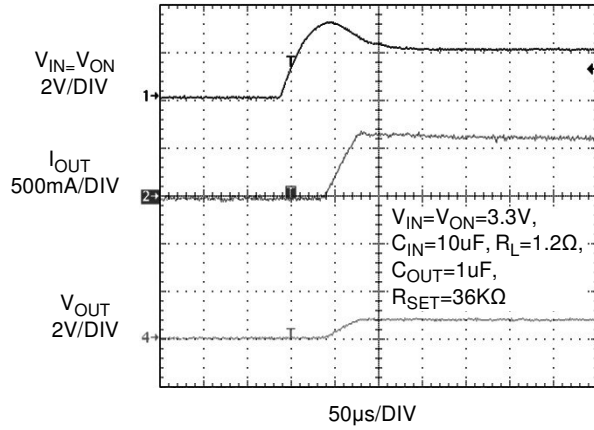

Figure 21. Current Limit Response
(Switch is powered into a short - Input and enable pin are tied together)

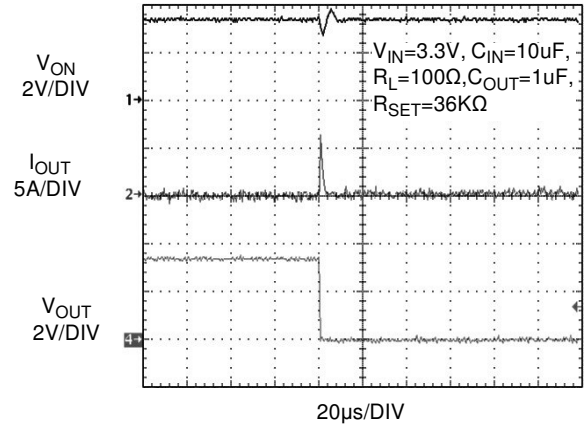

Figure 22. Short Circuit Response Time
(Output shorted to GND while the switch is in normal operation)

Description of Operation

The FPF2223, FPF2224, and FPF2225 are state of the art Adjustable High Precision Current Limit switches that protect systems and loads which can be damaged or disrupted by the application of high currents. The core of each device is a 0.16Ω P-channel MOSFET and a controller capable of functioning over an input operating range of 1.8- 5.5V. The controller protects or offers current limiting, UVLO(undervoltage lockout) and thermal shutdown protection. The current limit is adjustable from 250mA to 625mA through the selection of an external resistor.

On/Off Control

The ON pin is active high, and controls the state of the switch. Applying a continuous high signal will hold the switch in the on state. The switch will move into the OFF state when the active high is removed, or if a fault is encountered. For all versions, an undervoltage on VIN or a junction temperature in excess of 140°C overrides the ON control to turn off the switch.

In addition, excessive currents will cause the switch to turn off in the FPF2223 and FPF2224. The FPF2223 has an Auto-Restart feature which will automatically turn the switch on again after 450ms. For the FPF2224, the ON pin must be toggled to turn-on the switch again. The FPF2225 does not turn off in response to an over current condition but instead remains operating in a constant current mode so long as ON is active and the thermal shutdown or UVLO have not activated.

Fault Reporting

Upon the detection of an over-current condition, an input UVLO, or an over-temperature condition, the FLAGB signals the fault mode by activating LO. In the event of an over-current condition for the FPF2223 and FPF2224, the FLAGB goes LO at the end of the blanking time while FLAGB goes LO immediately for the FPF2225. If the over-current condition lasts longer than blanking time, FLAGB remains LO through the Auto-Restart Time for the FPF2223 while for the FPF2224, FLAGB is latched LO and ON must be toggled to release it. With the FPF2225, FLAGB is LO during the faults and immediately returns HI at the end of the fault condition. FLAGB is an open-drain MOSFET which requires a pull-up resistor between VIN and FLAGB. During shutdown, the pull-down on FLAGB is disabled to reduce current draw from the supply. A 100KΩ pull up resistor is recommended to be used in the application.

Current Limiting

The current limit ensures that the current through the switch doesn't exceed a maximum value while not limiting at less than a minimum value. The current at which the parts will limit is adjustable through the selection of an external resistor connected to the ISET pin. The FPF2223 and FPF2224 have a blanking time of 30ms (nominal) during which the switch will act as a constant current source. At the end of the blanking time, the switch will be turned-off. The FPF2225 has no current limit blanking period so it will remain in a constant current state until the ON pin is deactivated or the thermal shutdown turns-off the switch.

Undervoltage Lockout (UVLO)

The undervoltage lockout turns-off the switch if the input voltage drops below the undervoltage lockout threshold. With the ON pin active the input voltage rising above the undervoltage lockout threshold will cause a controlled turn-on of the switch which limits current over-shoots.

Output Discharge Resistor

The FPF2223/4/5 family contains an 80Ω on-chip load resistor for quick output discharge when the switch is turned off. This features become more attractive when application requires large output capacitor to be discharge when the switch turns off. However, V_{OUT} pin should not be connected directly to the battery source due to the discharge mechanism of the load switch.

Thermal Shutdown

The thermal shutdown protects the die from internally or externally generated excessive temperatures. During an over-temperature condition the FLAGB is activated and the switch is turned-off. The switch automatically turns-on again if temperature of the die drops below the threshold temperature.

Application Information

Setting Current Limit

The FPF2223, FPF2224, and FPF2225 have adjustable high precision current limit which is set with an external resistor connected between ISET and GND. Please see the layout recommendation section of the application note for the recommended R_{SET} layout. The R_{SET} resistance is selected by using the following equation:

$$I_{LIM(Typ)} (mA) = \frac{23764}{R_{SET} (K\Omega)}$$

For a particular I_{LIM(min)} value, R_{SET} can be calculated from below formula:

$$R_{SET} (K\Omega) = \frac{23764}{I_{LIM(Min)} (mA) + 25 + \frac{4700}{I_{LIM(Min)} (mA)}}$$

FPF222X family has 5% precision at higher load current. The I_{LIM(Max)} and tolerance of current limit value can be determined using Figure 23 (I_{LIM} vs R_{SET}) and the following formula:

$$\text{Tolerance (\%)} = 100 * \frac{I_{LIM(Typ)} - I_{LIM(Min)}}{I_{LIM(Typ)}}$$

$$I_{LIM(Max)} = I_{LIM(Typ)} + \frac{I_{LIM(Typ)} * \text{Tolerance (\%)}}{100}$$

The table and figure below can be used to select R_{SET}:

| R _{SET} [kΩ] | Min. Current Limit [mA] | Typ. Current Limit [mA] | Max. Current Limit [mA] | Tol [%] |
|-----------------------|-------------------------|-------------------------|-------------------------|---------|
| 36.0 | 627.0 | 660.0 | 693.0 | 5.0 |
| 37.5 | 600.9 | 633.7 | 666.5 | 5.2 |
| 39.0 | 576.2 | 609.3 | 642.5 | 5.4 |
| 40.2 | 557.7 | 591.1 | 624.5 | 5.7 |
| 42.2 | 529.3 | 563.1 | 597.0 | 6.0 |
| 44.2 | 503.3 | 537.6 | 572.0 | 6.4 |
| 49.0 | 449.5 | 485.0 | 520.4 | 7.3 |
| 51.1 | 429.1 | 465.0 | 501.0 | 7.7 |
| 54.9 | 396.0 | 432.9 | 469.7 | 8.5 |
| 61.9 | 345.3 | 383.9 | 422.5 | 10.1 |
| 69.8 | 299.8 | 340.5 | 381.1 | 11.9 |
| 80.9 | 250.0 | 293.7 | 337.5 | 14.9 |

Table 1: R_{SET} Selection Guide

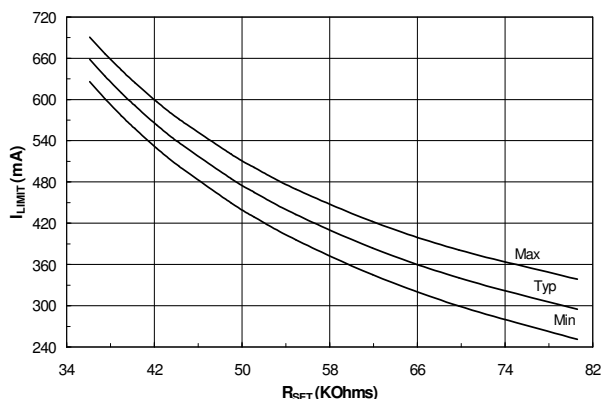

Figure 23. I_{LIM} vs R_{SET}

Input Capacitor

To limit the voltage drop on the input supply caused by transient in-rush currents when the switch is turned on into a discharged load capacitor or a short-circuit, a capacitor is recommended to be placed between V_{IN} and GND. A 1uF ceramic capacitor, C_{IN}, placed close to the pins is usually sufficient. Higher values of C_{IN} can be used to further reduce the voltage drop.

Output Capacitor

A 0.1uF capacitor C_{OUT}, should be placed between V_{OUT} and GND. This capacitor will prevent parasitic board inductances from forcing V_{OUT} below GND when the switch turns-off. For the FPF2223 and FPF2224, the total output capacitance needs to be kept below a maximum value, C_{OUT(max)}, to prevent the part from registering an over-current condition and turning-off the switch. The maximum output capacitance can be determined from the following formula:

$$C_{OUT(Max)} = \frac{I_{LIM(Max)} * t_{BLANK(Min)}}{V_{IN}}$$

Power Dissipation

During normal on-state operation, the power dissipated in the device will depend upon the level at which the current limit is set. The maximum allowed setting for the current limit is 625mA and will result in a power dissipation of:

$$P = (I_{LIM})^2 * R_{DS} = (0.625)^2 * 0.165 = 64mW$$

If the part goes into current limit, maximum power dissipation will occur when the output is shorted to ground. For the FPF2223, the power dissipation will be scaled by the Auto-Restart Time, t_{RSTRT}, and the Over Current Blanking Time, t_{BLANK}. Therefore, the maximum power dissipated is:

$$P_{(Max)} = \frac{t_{BLANK}}{t_{BLANK} + t_{RSTRT}} * V_{IN(Max)} * I_{LIM(Max)}$$

$$= \frac{30}{30 + 450} * 5.5 * 0.693 = 0.238W$$

Take note that this is below the maximum package power dissipation, and the thermal shutdown feature will act as additional safety to protect the part from damage due to excessive heating. The junction temperature is only able to increase to the thermal shutdown threshold. Once this temperature has been reached, toggling ON will not turn-on the switch until the junction temperature drops. For the FPF2225, a short on the output will cause the part to operate in a constant current state dissipating a worst case power of:

$$P_{(Max)} = V_{IN (MAX)} * I_{LIM (MAX)} = 5.5 * 0.693 = 3.8W$$

This large amount of power will activate the thermal shutdown and the part will cycle in and out of thermal shutdown so long as the ON pin is active and the short is present.

PCB Layout Recommendations

In order to benefit from adjustable, high-precision load switch devices, a high-precision R_{SET} value must be used to set a tight current limit tolerance. Since I_{LIMIT} (current limit value) is determined by the voltage drop across the R_{SET} , a poor PCB layout can introduce parasitic noise on the I_{SET} pin resulting in a minor variation of I_{LIMIT} . To improve the I_{LIMIT} stability, parasitic noise coupling mechanisms from I_{SET} to GND must be minimized. This becomes more critical when I_{LIMIT} is set close to the nominal load current operation where parasitic effects could cause the device to go in and out of current limit and result in an error flag report.

Care must be taken to provide a direct current return path between the R_{SET} ground pad and the device ground pad (pin5). Please see current pad #2 in figure below.

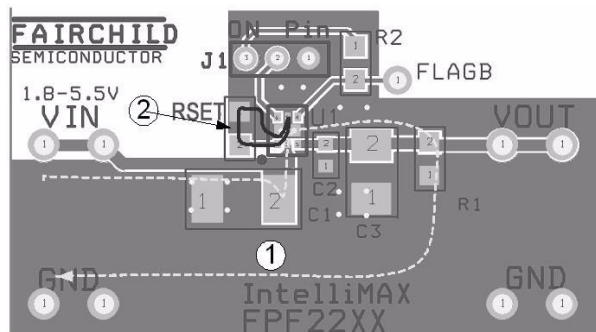

- 1) Power current path
- 2) RSET current path

Figure 24: Eliminate parasitic noise of ISET-GND by providing a separate ground route, unique from the power ground plane

Improving Thermal Performance

An improper layout could result in higher junction temperature and triggering the thermal shutdown protection feature. This concern applies when the switch is set at higher current limit value and an over-current condition occurs. In this case, the power dissipation of the switch, from the formula below, could exceed the maximum absolute power dissipation of 1.2W.

$$PD = (V_{IN} - V_{OUT}) * I_{LIM (Max)}$$

The following techniques have been identified to improve the thermal performance of this family of devices. These techniques are listed in order of the significance of their impact.

1. Thermal performance of the load switch can be improved by connecting pin7 of the DAP (Die Attach Pad) to the GND plane of the PCB.
2. Embedding two exposed through-hole vias into the DAP (pin7) provides a path for heat to transfer to the back GND plane of the PCB. A drill size of Round, 14 mils (0.35mm) with 1-ounce copper plating is recommended to result in appropriate solder reflow. A smaller size hole prevents the solder from penetrating into the via, resulting in device lift-up. Similarly, a larger via-hole consumes excessive solder, and may result in voiding of the DAP.

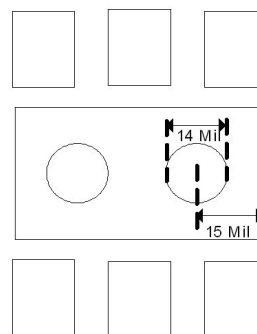

Figure 25: Two through hole open vias embedded in DAP

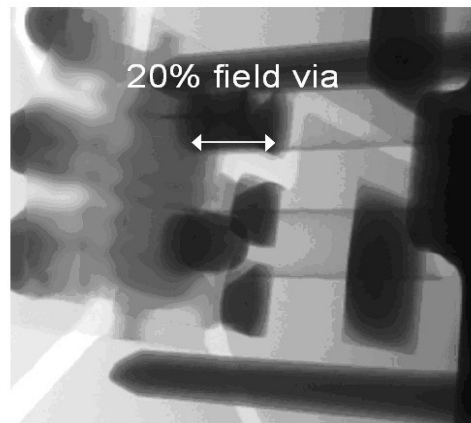

Figure 26: X-Ray result (bottom view with 45° angle)

3. The V_{IN} , V_{OUT} and GND pins will dissipate most of the heat generated during a high load current condition. Using wide traces will help minimize parasitic electrical effects along with minimizing the case to ambient thermal impedance. The layout suggested in Figure 27 provides each pin with adequate copper so that heat may be transferred as efficiently as possible out of the device. The low-power FLAGB and ON pin traces may be laid-out diagonally from the device to maximize the area available to the ground pad. Placing the input and output capacitors as close to the device as possible also contributes to heat dissipation, particularly during high load currents.

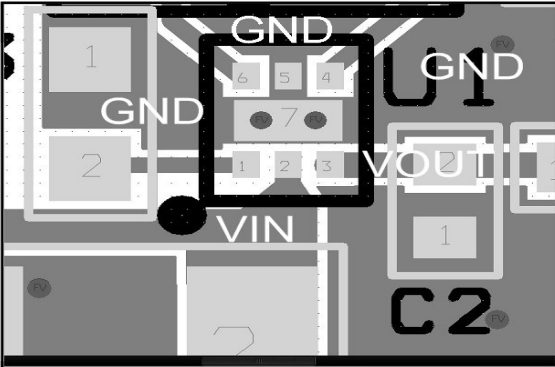

Figure 27: Proper layout of output and ground copper area

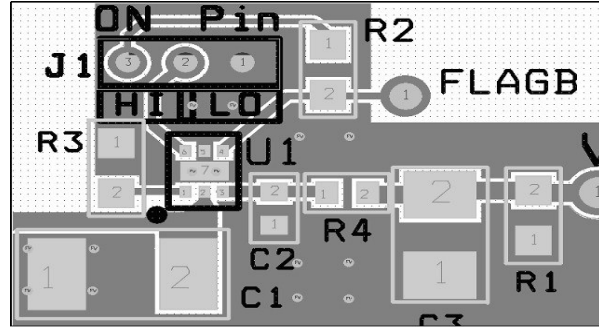

Figure 30: Zoom in to Top layer

FPF22XX Demo Board

FPF22XX Demo board has components and circuitry to demonstrate FPF2223/4/5 load switches functions and features. R4 resistor with 0Ω value is used for measuring the output current. Load current can be scoped by removing the R4 resistor and soldering a current loop to the R4 footprint. Thermal performance of the board is improved using a few techniques recommended in the layout recommendations section of datasheet.

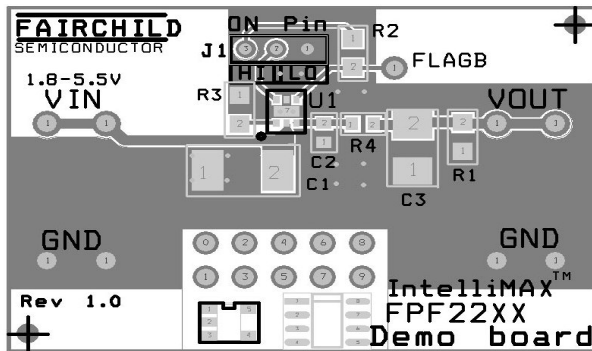

Figure 28: Top, SST, and AST Layers

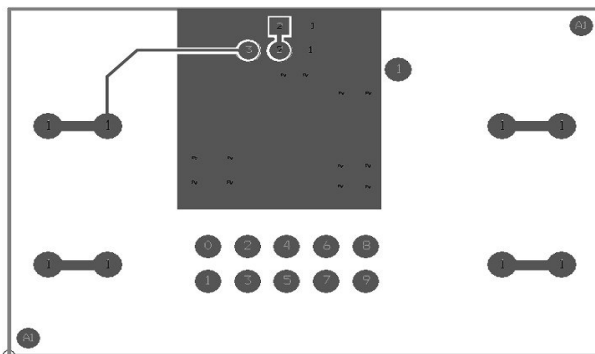
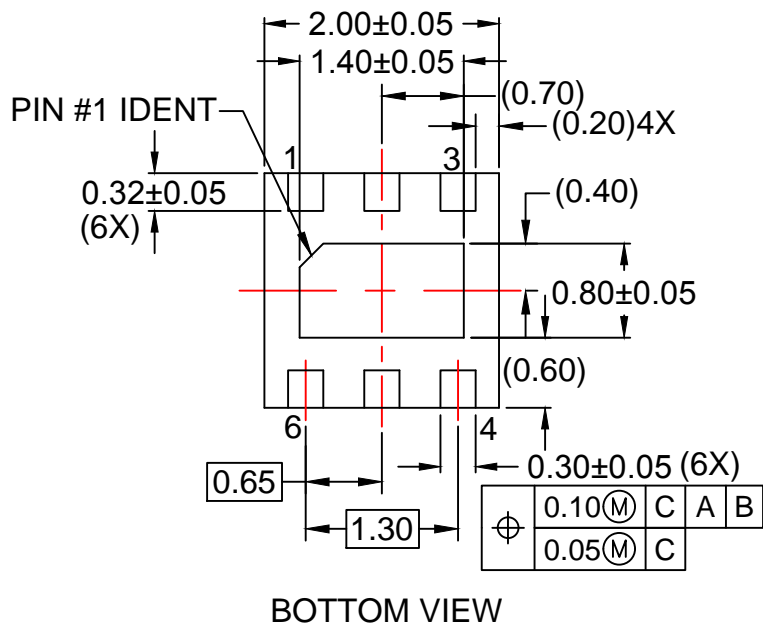
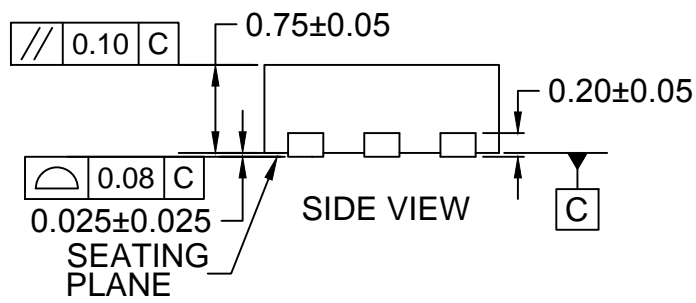
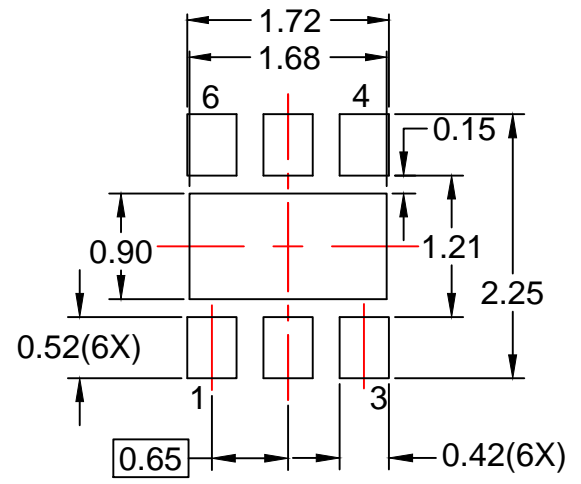
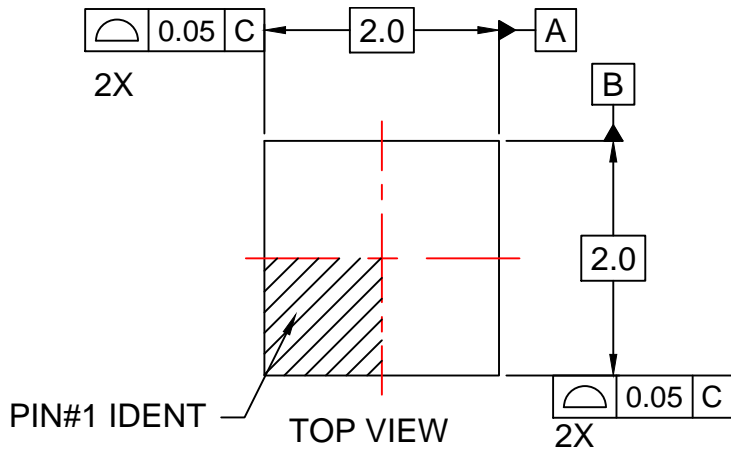

Figure 29: Bottom and ASB Layers



NOTES:





- A. PACKAGE DOES NOT FULLY CONFORM TO JEDEC MO-229 REGISTRATION
- B. DIMENSIONS ARE IN MILLIMETERS.
- C. DIMENSIONS AND TOLERANCES PER ASME Y14.5M, 2009.
- D. LAND PATTERN RECOMMENDATION IS EXISTING INDUSTRY LAND PATTERN.
- E. DRAWING FILENAME: MKT-MLP06Krev5.





TRADEMARKS

The following includes registered and unregistered trademarks and service marks, owned by Fairchild Semiconductor and/or its global subsidiaries, and is not intended to be an exhaustive list of all such trademarks.

- | | | | |
|---|--|---|---|
| AccuPower™ | F-PFS™ | OPTOPLANAR® |  |
| AttitudeEngine™ | FRFET® |  | TinyBoost® |
| Awinda® | Global Power Resource SM | PowerTrench® | TinyBuck® |
| AX-CAP®* | GreenBridge™ | PowerXS™ | TinyCalc™ |
| BitSiC™ | Green FPS™ | Programmable Active Droop™ | TinyLogic® |
| Build it Now™ | Green FPS™ e-Series™ | QFET® | TINYOPTO™ |
| CorePLUS™ | Gmax™ | QS™ | TinyPower™ |
| CorePOWER™ | GTO™ | Quiet Series™ | TinyPWM™ |
| CROSSVOLT™ | IntelliMAX™ | RapidConfigure™ | TinyWire™ |
| CTL™ | ISOPLANAR™ |  | TranSiC™ |
| Current Transfer Logic™ | Making Small Speakers Sound Louder and Better™ | Saving our world, 1mW/W/kW at a time™ | TriFault Detect™ |
| DEUXPEED® | MegaBuck™ | SignalWise™ | TRUECURRENT®* |
| Dual Cool™ | MICROCOUPLER™ | SmartMax™ | μSerDes™ |
| EcoSPARK® | MicroFET™ | SMART START™ |  |
| EfficientMax™ | MicroPak™ | Solutions for Your Success™ | UHC® |
| ESBC™ | MicroPak2™ | SPM® | Ultra FRFET™ |
|  | MillerDrive™ | STEALTH™ | UniFET™ |
| Fairchild® | MotionMax™ | SuperFET® | VCX™ |
| Fairchild Semiconductor® | MotionGrid® | SuperSOT™-3 | VisualMax™ |
| FACT Quiet Series™ | MTI® | SuperSOT™-6 | VoltagePlus™ |
| FACT® | MTX® | SuperSOT™-8 | XS™ |
| FAST® | MVN® | SupreMOS® | Xsens™ |
| FastvCore™ | mWSaver® | SyncFET™ | 仙童™ |
| FETBench™ | OptoHiT™ | Sync-Lock™ | |
| FPS™ | OPTOLOGIC® | | |

* Trademarks of System General Corporation, used under license by Fairchild Semiconductor.

DISCLAIMER

FAIRCHILD SEMICONDUCTOR RESERVES THE RIGHT TO MAKE CHANGES WITHOUT FURTHER NOTICE TO ANY PRODUCTS HEREIN TO IMPROVE RELIABILITY, FUNCTION, OR DESIGN. TO OBTAIN THE LATEST, MOST UP-TO-DATE DATASHEET AND PRODUCT INFORMATION, VISIT OUR WEBSITE AT [HTTP://WWW.FAIRCHILDSEMI.COM](http://www.fairchildsemi.com). FAIRCHILD DOES NOT ASSUME ANY LIABILITY ARISING OUT OF THE APPLICATION OR USE OF ANY PRODUCT OR CIRCUIT DESCRIBED HEREIN; NEITHER DOES IT CONVEY ANY LICENSE UNDER ITS PATENT RIGHTS, NOR THE RIGHTS OF OTHERS. THESE SPECIFICATIONS DO NOT EXPAND THE TERMS OF FAIRCHILD'S WORLDWIDE TERMS AND CONDITIONS, SPECIFICALLY THE WARRANTY THEREIN, WHICH COVERS THESE PRODUCTS.

LIFE SUPPORT POLICY

FAIRCHILD'S PRODUCTS ARE NOT AUTHORIZED FOR USE AS CRITICAL COMPONENTS IN LIFE SUPPORT DEVICES OR SYSTEMS WITHOUT THE EXPRESS WRITTEN APPROVAL OF FAIRCHILD SEMICONDUCTOR CORPORATION.

As used herein:

- Life support devices or systems are devices or systems which, (a) are intended for surgical implant into the body or (b) support or sustain life, and (c) whose failure to perform when properly used in accordance with instructions for use provided in the labeling, can be reasonably expected to result in a significant injury of the user.
- A critical component in any component of a life support, device, or system whose failure to perform can be reasonably expected to cause the failure of the life support device or system, or to affect its safety or effectiveness.

ANTI-COUNTERFEITING POLICY

Fairchild Semiconductor Corporation's Anti-Counterfeiting Policy. Fairchild's Anti-Counterfeiting Policy is also stated on our external website, www.fairchildsemi.com, under Sales Support.

Counterfeiting of semiconductor parts is a growing problem in the industry. All manufacturers of semiconductor products are experiencing counterfeiting of their parts. Customers who inadvertently purchase counterfeit parts experience many problems such as loss of brand reputation, substandard performance, failed applications, and increased cost of production and manufacturing delays. Fairchild is taking strong measures to protect ourselves and our customers from the proliferation of counterfeit parts. Fairchild strongly encourages customers to purchase Fairchild parts either directly from Fairchild or from Authorized Fairchild Distributors who are listed by country on our web page cited above. Products customers buy either from Fairchild directly or from Authorized Fairchild Distributors are genuine parts, have full traceability, meet Fairchild's quality standards for handling and storage and provide access to Fairchild's full range of up-to-date technical and product information. Fairchild and our Authorized Distributors will stand behind all warranties and will appropriately address any warranty issues that may arise. Fairchild will not provide any warranty coverage or other assistance for parts bought from Unauthorized Sources. Fairchild is committed to combat this global problem and encourage our customers to do their part in stopping this practice by buying direct or from authorized distributors.

PRODUCT STATUS DEFINITIONS

Definition of Terms

| Datasheet Identification | Product Status | Definition |
|--------------------------|-----------------------|---|
| Advance Information | Formative / In Design | Datasheet contains the design specifications for product development. Specifications may change in any manner without notice. |
| Preliminary | First Production | Datasheet contains preliminary data; supplementary data will be published at a later date. Fairchild Semiconductor reserves the right to make changes at any time without notice to improve design. |
| No Identification Needed | Full Production | Datasheet contains final specifications. Fairchild Semiconductor reserves the right to make changes at any time without notice to improve the design. |
| Obsolete | Not In Production | Datasheet contains specifications on a product that is discontinued by Fairchild Semiconductor. The datasheet is for reference information only. |

Rev. I73