

XS630B5NAM12

inductive sensor XS6 M30 - L74mm - brass -
Sn30mm - 12..48VDC - M12



Main

Range of product	OsiSense XS
Series name	General purpose
Sensor type	Inductive proximity sensor
Device application	Mobile equipment
Sensor name	XS6
Sensor design	Cylindrical M30
Size	74 mm
Body type	Fixed
Detector flush mounting acceptance	Non flush mountable
Material	Metal
Type of output signal	Discrete
Wiring technique	3-wire
[Sn] nominal sensing distance	30 mm
Discrete output function	1 NO
Output circuit type	DC
Discrete output type	NPN
Electrical connection	Male connector M12 4 pins
[Us] rated supply voltage	12...48 V DC with reverse polarity protection
Switching capacity in mA	<= 200 mA DC with overload and short-circuit protection
IP degree of protection	IP65 conforming to IEC 60529 IP69K IP67 conforming to DIN 40050

Complementary

Thread type	M30 x 1.5
Detection face	Frontal
Front material	PPS
Enclosure material	Nickel plated brass
Operating zone	0...24 mm
Differential travel	1...15% of Sr
Status LED	1 LED (yellow) for output state
Supply voltage limits	10...58 V DC
Switching frequency	<= 500 Hz DC
Voltage drop	<= 2 V, closed state
Current consumption	<= 10 mA (no-load)
Delay first up	<= 15 ms
Delay response	<= 0.6 ms
Delay recovery	<= 1.4 ms
Marking	CE
Threaded length	39 mm
Length	74 mm
Product weight	0.145 kg

Environment

The information provided in this documentation contains general descriptions and/or technical characteristics of the performance of the products contained herein. This documentation is not intended as a substitute for and is not to be used for determining suitability or reliability of these products for specific user applications. It is the duty of any such user or integrator to perform the appropriate and complete risk analysis, evaluation and testing of the products with respect to the relevant specific application or use thereof. Neither Schneider Electric Industries SAS nor any of its affiliates or subsidiaries shall be responsible or liable for misuse of the information contained herein.

product certifications	CSA UL E2
ambient air temperature for operation	-25...70 °C
ambient air temperature for storage	-40...85 °C
vibration resistance	25 gn, amplitude: +/- 2 mm (f = 10...55 Hz) conforming to IEC 60068-2-6
shock resistance	50 gn (duration = 11 ms) conforming to IEC 60068-2-27

Offer Sustainability

Sustainable offer status	Green Premium product
RoHS (date code: YYWW)	Compliant - since 1550 - Schneider Electric declaration of conformity
REACH	Reference not containing SVHC above the threshold
Product environmental profile	Available
Product end of life instructions	Available

Contractual warranty

Warranty period	18 months
-----------------	-----------

Dimensions

With M12 Connector

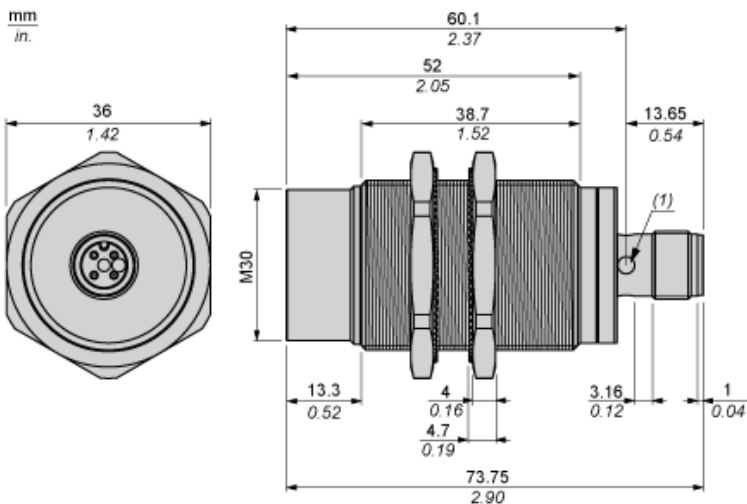

(1) Yellow LED (Output state indication)

Mounting and Clearance

Minimum Mounting Distances

Side by Side

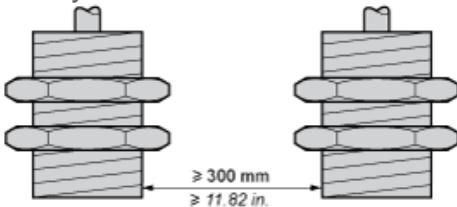

Face to Face

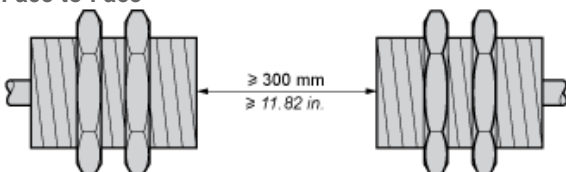

Facing a Metal Object

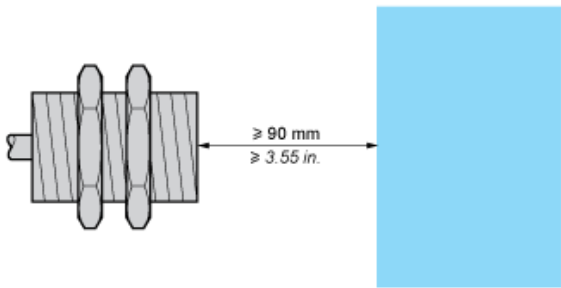

Mounted in a Metal Support

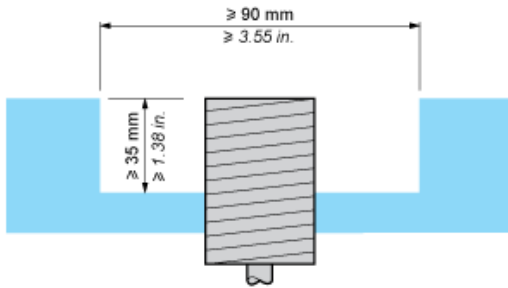

Connection and Schema

Wiring Schemes

M12 connector

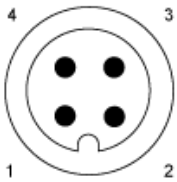

Connection and Schema

Wiring Schemes

NPN 3-wire

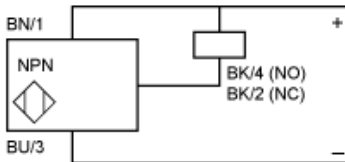

BN : Brown

BK : Black

BU : Blue

Performance Curves

Standard Steel Target: 45 x 45 x 1 mm

Operating zone: 0...24 mm

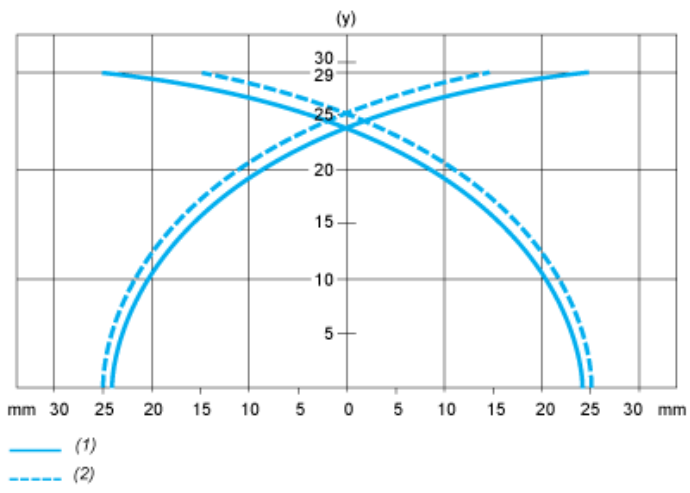

- (y) Sensing distance in mm
- (1) Pick-up points
- (2) Drop-out points (object approaching from the side)