

JUMO di 308

JUMO dTRON 304/308/316



Typ/Type 703041



Typ/Type 703043



Typ/Type 701550



Typ/Type 703042



Typ/Type 703044

B 70.1550.4

B 70.3041.4

Baugruppen nachrüsten

Retrofitting of modules

Ajout des extensions





 Das Nachrüsten der Baugruppen darf nur von qualifiziertem Fachpersonal durchgeführt werden.

 Only qualified personnel are permitted to carry out module retrofits.

 L'ajout d'extensions ne doit être effectué que par du personnel qualifié.

 Die Baugruppen können durch elektrostatische Entladung beschädigt werden. Vermeiden Sie deshalb beim Ein- und Ausbau elektrostatische Aufladung. Nehmen Sie das Nachrüsten der Baugruppen an einem geerdeten Arbeitsplatz vor.



 Risk of damage to the modules by electrostatic discharge. For this reason, avoid electrostatic charge during fitting and removal. Carry out retrofitting on a grounded workbench.

 Les décharges électrostatiques peuvent endommager les extensions. C'est pourquoi vous devez éviter les charges électrostatiques lors du montage et du démontage. Procédez au montage des extensions sur un plan de travail relié à la terre.

Baugruppen nachrüsten

Baugruppe identifizieren

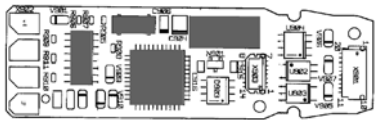
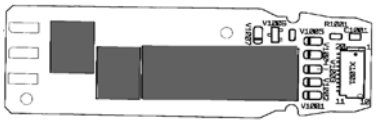
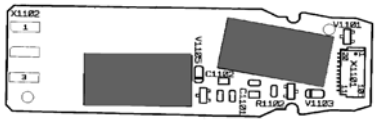
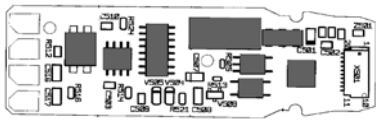
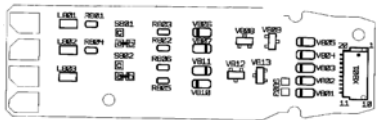
* Identifizieren der Baugruppe anhand der aufgeklebten Verkaufs-Artikel-Nummer auf der Verpackung

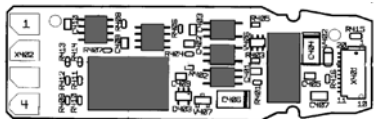
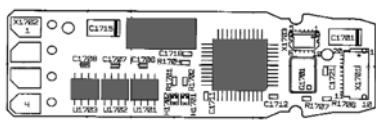
Baugruppen	Code	Verkaufs-Artikel-Nr.	Platinenansicht
Analogeingang 2	1	70/00442785	
1 Relais (Wechselkontakt)	2	70/00442786	
2 Relais (Schließer)	3	70/00442787	
1 Analogausgang	4	70/00442788	
2 Binäreingänge	5	70/00442789	
1 Halbleiterrelais 230V/1A	6	70/00442790	
Schnittstelle RS422/485	7	70/00442782	
PROFIBUS-DP	8	70/00442791	

Baugruppen nachrüsten

JUMO di 308

Gerätein-
schub heraus-
nehmen

- * Frontplatte an den geriffelten Flächen (links und rechts) zusammendrücken und Gerätein-
schub herausziehen

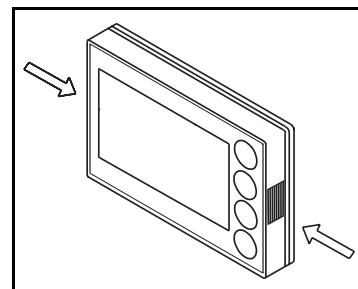

Baugruppe
nachrüsten

- * Optionssteckplatz auswählen

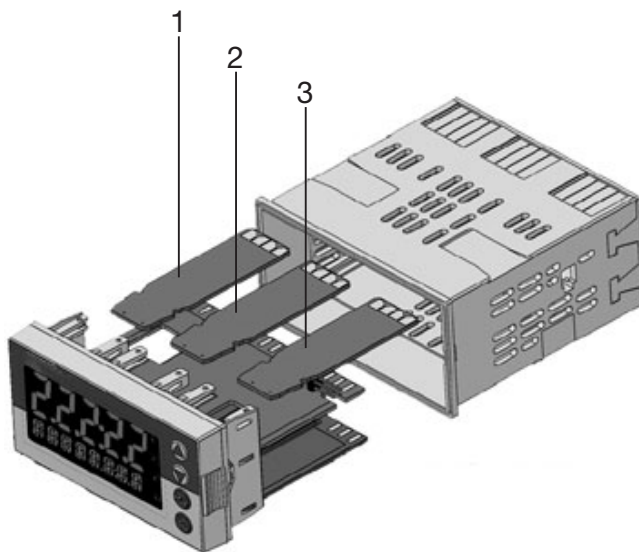

- * Baugruppe in den Steckplatz einschieben, bis der Steckverbinder einrastet

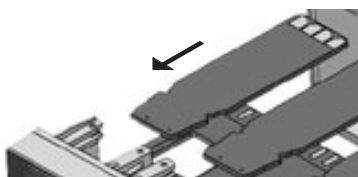

- * Gerätein-
schub in das Gehäuse schieben, bis die Rastnasen in die dafür vorgesehenen Nuten einrasten

JUMO dTRON 304/308/316

Geräteein-
schub heraus-
nehmen

- * Frontplatte an den geriffelten Flächen (oben und unten bzw. links und rechts bei Querformat) zusammendrücken und Reglereinschub herausziehen

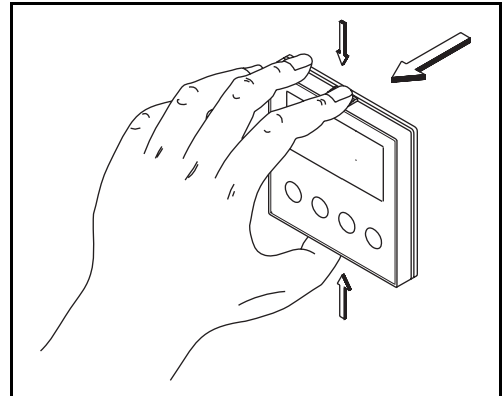

Baugruppe
nachrüsten

- * Optionssteckplatz auswählen
(Einschränkungen bei Typ 703041 beachten!)

Typ 703041

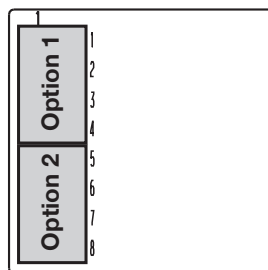

Bei Typ 703041
sind Relais nur auf
Optionssteckplatz 1
nachrüstbar!

Typ 703042/43/44

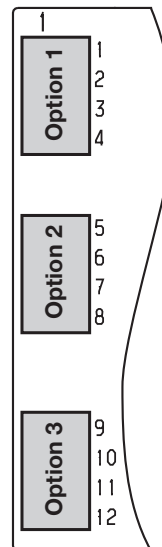

- * Baugruppe in den Steckplatz einschieben, bis der Steckverbinder einrastet

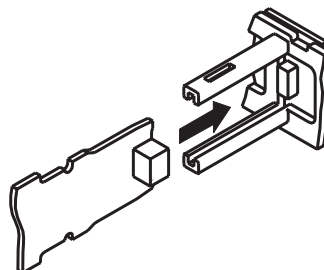





- * Geräteeinschub in das Gehäuse schieben bis die Rastnasen in die dafür vorgesehenen Nuten einrasten

Baugruppen nachrüsten

Retrofitting of modules

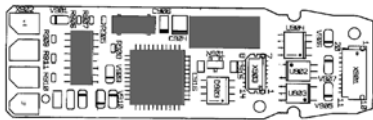
Identifying the module

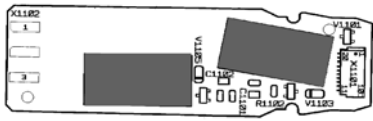
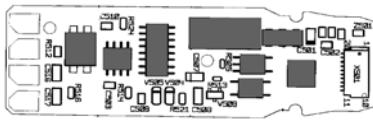
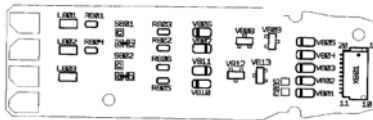
* Identify the module by the sales number pasted on the packaging

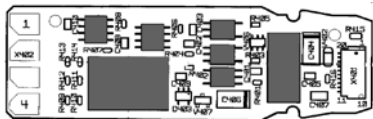
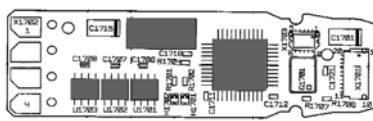
Modules	Code	Sales No.	View of boards
Analog input 2	1	70/00442785	
1 relay (changeover)	2	70/00442786	
2 relays (make, N/O)	3	70/00442787	
1 analog output	4	70/00442788	
2 binary inputs	5	70/00442789	
1 solid-state relay 230V/1A	6	70/00442790	
Interface RS422/485	7	70/00442782	
PROFIBUS-DP	8	70/00442791	

Retrofitting of modules

JUMO di 308

Removing the controller module

- * Press together the knurled surfaces on the front panel (left and right), and pull out the controller module

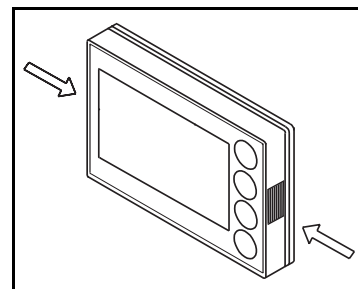

Retrofitting of modules

- * Select slot for the option

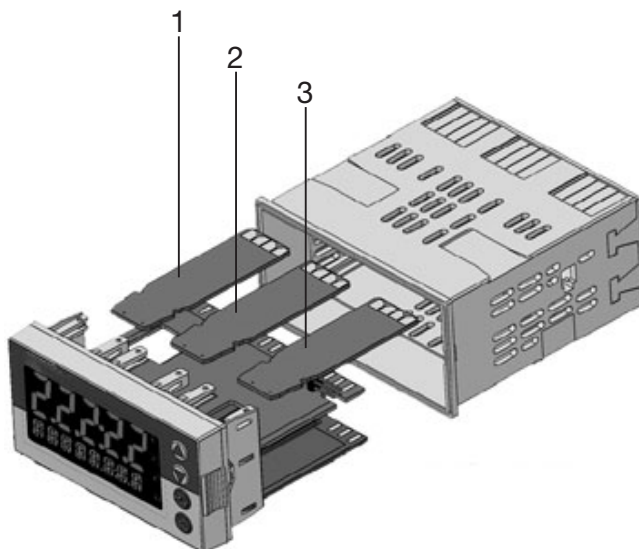

- * Push the module into the slot until the plug connector engages

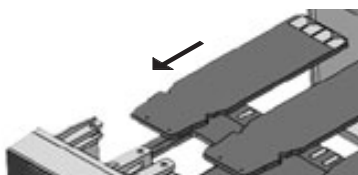

- * Push the module into the housing until the lugs engage in their slots

JUMO dTRON 304/308/316

Removing the controller module

- * Press together the knurled surfaces on the front panel (top and bottom, or left and right for landscape format) and pull out the controller module

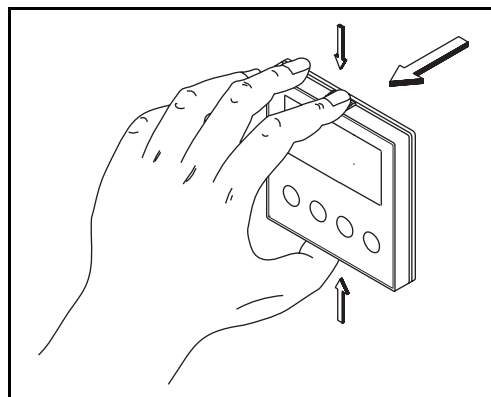

Retrofitting of modules

- * Select the slot for the option (Observe the restrictions for Type 703041!)

Type 703041

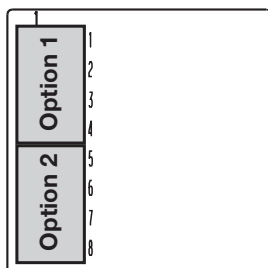

On Type 703041, relays can only be retrofitted in option slot 1!

Type 703042/43/44

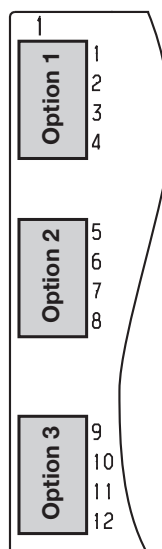

- * Push the module into the slot until the plug connector snaps into place

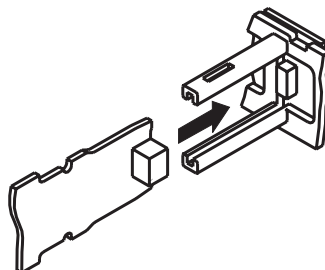





- * Push the module into the housing until the lugs snap into their slots

Retrofitting of modules

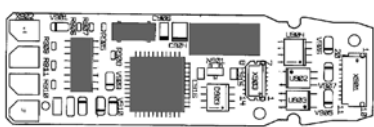
Identifier l'extension

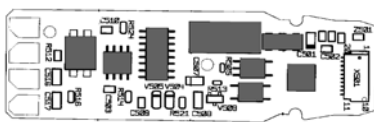
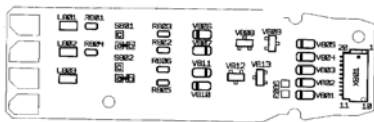
* Identifier l'extension à l'aide du numéro d'article collé sur l'emballage

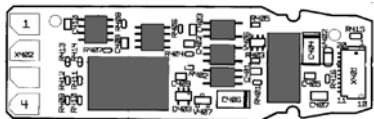
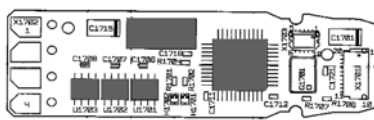
Extension	Code	Numéro d'article	Vue de la platine
Entrée analogique 2	1	70/00442785	
1 relais (contact inverseur)	2	70/00442786	
2 relais (à fermeture)	3	70/00442787	
1 sortie analogique	4	70/00442788	
2 entrées binaires	5	70/00442789	
1 relais statique 230 V/1 A	6	70/00442790	
Interface RS422/485	7	70/00442782	
PROFIBUS-DP	8	70/00442791	

Ajout des extensions

JUMO di 308

Retirer
la plaque
du régulateur

- * Appuyer simultanément sur les surfaces striées de la façade (à gauche et à droite) et enlever la plaque du régulateur

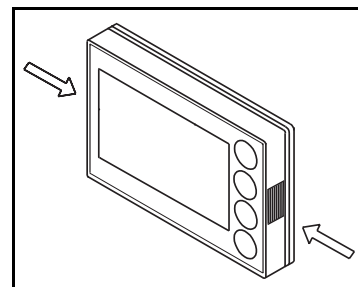

Ajouter
une extension

- * Choisir le connecteur en option

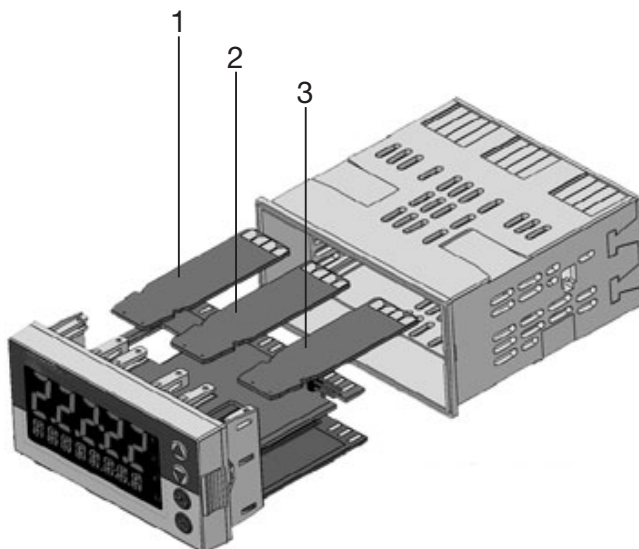

- * Introduire l'extension dans le connecteur jusqu'à ce que le connecteur soit encliqueté

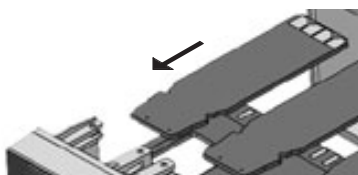

- * Pousser la plaque du régulateur dans le boîtier jusqu'à ce que les ergots soient encliquetés dans les rainures prévues à cet effet.

JUMO dTRON 304/308/316

**Retirer
la plaque
du régulateur**

* Appuyer simultanément sur les surfaces striées de la façade (en haut et en bas pour le format vertical, à gauche et à droite pour le format horizontal) et enlever la plaque du régulateur

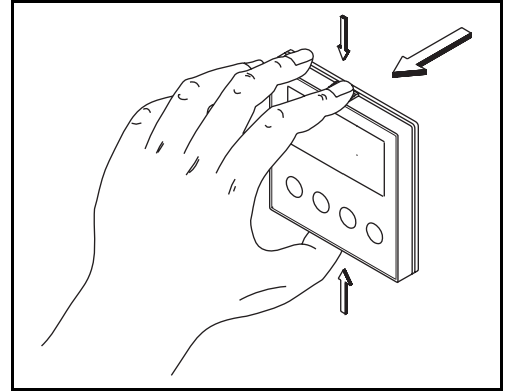

**Ajouter
une extension**

* Choisir le connecteur en option (attention aux limitations pour le type 703041 !)

Type 703041

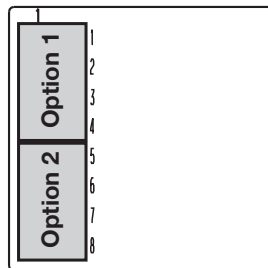

Type 703041 : on ne peut ajouter les relais que sur le connecteur en option 1 !

Type 703042/43/44

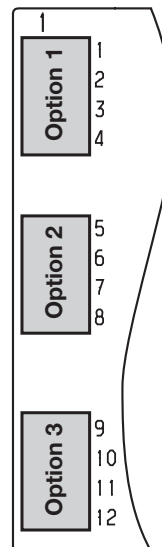

* Introduire l'extension dans le connecteur jusqu'à ce que le connecteur soit encliqueté

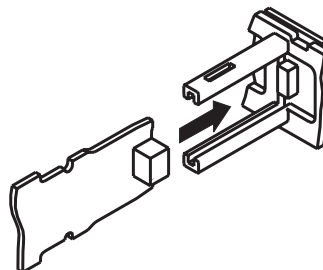

* Pousser la plaque du régulateur dans le boîtier jusqu'à ce que les ergots soient encliquetés dans les rainures prévues à cet effet.

Ajout des extensions



JUMO GmbH & Co. KG

Adresse :

Moltkestraße 13 - 31
36039 Fulda, Allemagne

Adresse de livraison :

Mackenrodtstraße 14
36039 Fulda, Allemagne

Adresse postale :

36035 Fulda, Allemagne

Téléphone : +49 661 6003-0

Télécopieur :+49 661 6003-607

E-Mail : mail@jumo.net

Internet : www.jumo.net

JUMO Régulation SAS

Actipôle Borny

7 Rue des Drapiers

B.P. 45200

57075 Metz - Cedex 3, France

Téléphone : +33 3 87 37 53 00

Télécopieur :+33 3 87 37 89 00

E-Mail : info@jumo.fr

Internet : www.jumo.fr

Service de soutien à la vente :

0892 700 733 (0,337 Euro/min)

JUMO Automation

S.P.R.L. / P.G.M.B.H. / B.V.B.A.

Industriestraße 18

4700 Eupen, Belgique

Téléphone : +32 87 59 53 00

Télécopieur :+32 87 74 02 03

E-Mail : info@jumo.be

Internet : www.jumo.be

JUMO Mess- und Regeltechnik AG

Laubisrütistrasse 70

8712 Stäfa, Suisse

Téléphone : +41 44 928 24 44

Télécopieur :+41 44 928 24 48

E-Mail : info@jumo.ch

Internet : www.jumo.ch



JUMO GmbH & Co. KG

Street address:

Moltkestraße 13 - 31
36039 Fulda, Germany

Delivery address:

Mackenrodtstraße 14
36039 Fulda, Germany

Postal address:

36035 Fulda, Germany

Phone: +49 661 6003-0

Fax: +49 661 6003-607

e-mail: mail@jumo.net

Internet: www.jumo.net

JUMO Instrument Co. Ltd.

JUMO House

Temple Bank, Riverway

Harlow, Essex CM 20 2 TT, UK

Phone: +44 1279 635533

Fax: +44 1279 635262

e-mail: sales@jumo.co.uk

Internet: www.jumo.co.uk

JUMO Process Control, Inc.

8 Technology Boulevard

Canastota, NY 13032, USA

Phone: 315-697-JUMO

1-800-554-JUMO

Fax: 315-697-5867

e-mail: info@jumo.us

Internet: www.jumo.us



JUMO GmbH & Co. KG

Hausadresse:

Moltkestraße 13 - 31
36039 Fulda, Germany

Lieferadresse:

Mackenrodtstraße 14
36039 Fulda, Germany

Postadresse:

36035 Fulda, Germany
Telefon: +49 661 6003-727
Telefax: +49 661 6003-508
E-Mail: mail@jumo.net
Internet: www.jumo.net

**JUMO Mess- und Regelgeräte
Ges.m.b.H.**

Pfarrgasse 48
1232 Wien, Austria
Telefon: +43 1 610610
Telefax: +43 1 6106140
E-Mail: info@jumo.at
Internet: www.jumo.at

JUMO Mess- und Regeltechnik AG

Laubisrütistrasse 70
8712 Stäfa, Switzerland
Telefon: +41 44 928 24 44
Telefax: +41 44 928 24 48
E-Mail: info@jumo.ch
Internet: www.jumo.ch

Bei technischen Rückfragen - Telefon-Support Deutschland:
Telefon: +49 661 6003-300 oder -653 oder -899
Telefax: +49 661 6003-881729
E-Mail: service@jumo.net