

ZWD225PAF Series Instruction Manual

BEFORE USING THE POWER SUPPLY UNIT



Pay attention to all warnings and cautions before using the unit. Incorrect usage could lead to an electrical shock, damage to the unit or a fire hazard.

WARNING and CAUTION

- Do not modify.
- Do not touch the internal components, they may have high voltage or high temperature. You may get electrical shock or burned.
- When the unit is operating, keep your hands and face away from it, you may get injured by an accident.
- This power supply is primarily designed and manufactured to be used and enclosed in other equipment. Stick the WARNING label for users on the system equipment and describe the notice in the instruction manual.
- Never operate the unit under over current or shorted conditions for 30 seconds or more and out of Input Voltage Range specification which could result in damage or insulation failure / smoking / burning.
- Confirm that connections to input/output terminals are correct as indicated in the instruction manual.
- This power supply is PC board type unit. Please hold the board edge while mounting, and do not touch the component side. Please lift the power supply with a spacer when mounting the power supply on any surface.
- Do not drop or apply shock to power supply unit.

Note: CE MARKING

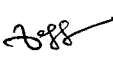
CE Marking, when applied to a product covered by this handbook indicates compliance with the low voltage directive (73/23/EEC) as modified by the CE Marking Directive (93/68/EEC) meaning that it complies with EN60950.

DWG No.	PA574-04-01	
APPD	CHK	DWG
		
17/Aug/04	17/8/04	17-08-2004

1. Terminal Explanation

1-1. ZWD225PAF

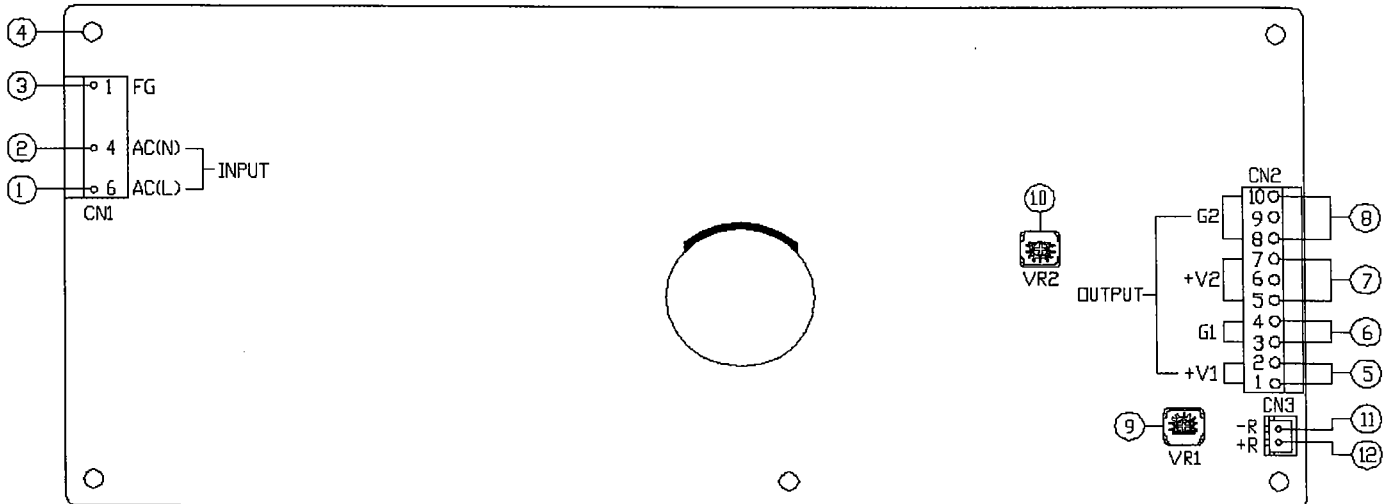

- ① L: AC Input terminal (pin 6 of CN1)
Live line (fuse in line)
- ② N: AC input terminal (pin 4 of CN1)
Neutral line
- ③ FG: Input terminal FG (pin 1 of CN1)
Safety earth (Frame Ground)
Connect to safety ground of apparatus or equipment.
- ④ FG: Frame Ground (Connected to pin 1 of CN1)
Must be connected to electrically safety ground of apparatus or equipment by electrically conductive spacers. The mounting surface of the spacer should be within MAX $\phi 8\text{mm}$.
- ⑤ V1: CH1 +ve Output terminal
- ⑥ G1: CH1 -ve Output terminal
- ⑦ V2: CH2 +ve Output terminal
- ⑧ G2: CH2 -ve Output terminal
- ⑨ V.ADJ: 5V Output Voltage adjust trimmer (VR1)
The 5V Output voltage rises when the trimmer is turned clockwise.
- ⑩ V.ADJ: 24V Output Voltage adjust trimmer (VR2)
The 24V Output voltage rises when the trimmer is turned clockwise.

- ⑪ -R : CN3 ON/OFF control -R terminal
- ⑫ +R : CN3 ON/OFF control +R terminal

*Input & Output connector (MOLEX)
(also for option model /L,/A)

	Connector	Recommended	
		Housing	Terminal Pin
Input (CN1)	5414-30B	5195-06 or 2139-06 or 3069-06	5194PBTL
Output (CN2)	5273-10A	5195-10 or 2139-10 or 3069-10	5194PBTL

*Output Current of each connector pin must be less than 5A.(7A at peak load)

*Hand Crimping Tooling : 11-26-0058 (MOLEX)

*Connector for Remote ON/OFF control: CN3 (J.S.T)

Connector	Housing	Recommended
		Terminal Pin
B2B - XH - A	XHP - 2	BXH - 001T - P0.6 or SXH - 001T - P0.6

*CN3 is normally shorted by JM-2W-96 (J.S.T)

*Hand Crimping Tool: YC-110R (J.S.T) or YRS-110 (J.S.T)

1-2. ZWD225PAF/J

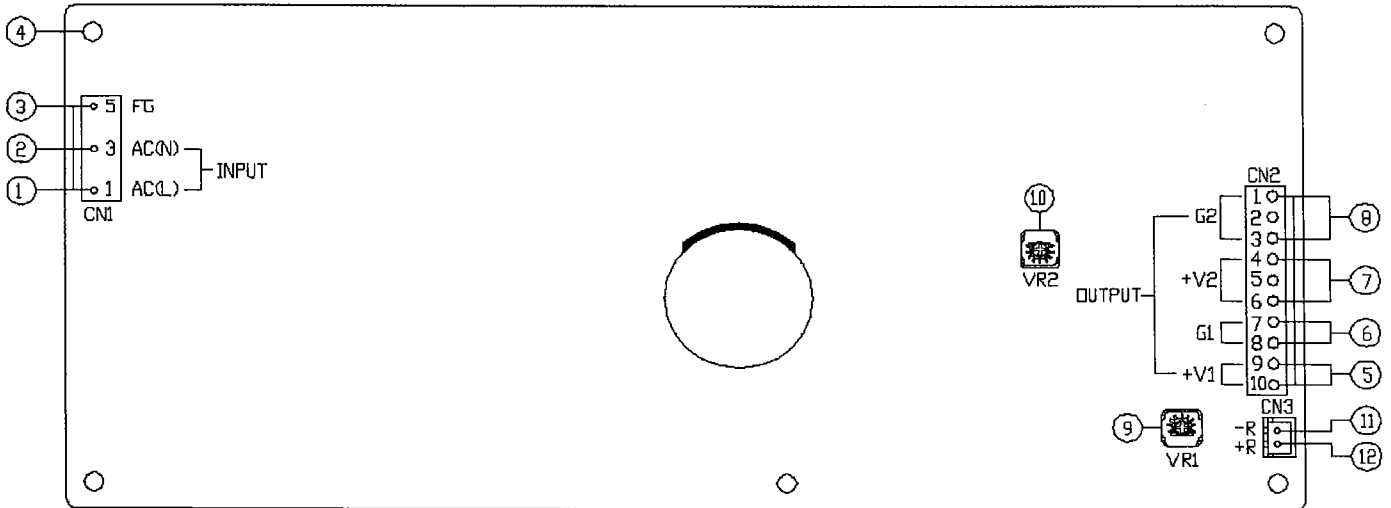

- ① L: AC Input terminal (pin 1 of CN1)
Live line (fuse in line)
- ② N: AC input terminal (pin 3 of CN1)
Neutral line
- ③ FG: Input terminal FG (pin 5 of CN1)
Safety earth (Frame Ground)
Connect to safety ground of apparatus or equipment.
- ④ FG: Frame Ground (Connected to pin 5 of CN1)
Must be connected to electrically safety ground of apparatus or equipment by electrically conductive spacers. The mounting surface of the spacer should be within MAX $\phi 8\text{mm}$.
- ⑤ V1: CH1 +ve Output terminal
- ⑥ G1: CH1 -ve Output terminal
- ⑦ V2: CH2 +ve Output terminal
- ⑧ G2: CH2 -ve Output terminal
- ⑨ V.ADJ: 5V Output Voltage adjust trimmer (VR1)
The 5V Output voltage rises when the trimmer is turned clockwise.
- ⑩ V.ADJ : 24V Output Voltage adjust trimmer (VR2)
The 24V Output voltage rises when the trimmer is turned clockwise.

- ⑪ -R : CN3 ON/OFF control -R terminal
- ⑫ +R : CN3 ON/OFF control +R terminal

*Input & Output connector (J.S.T)
 (also for option model /JL,/JA)

	Connector	Recommended	
		Housing	Terminal Pin
Input (CN1)	B3P5-VH	VHR-5N	SVH-21T-P1.1
Output (CN2)	B10P-VH	VHR-10N	SVH-21T-P1.1

*Output Current of each connector pin must be less than 5A.
 (7A at peak load)

*Hand Crimping Tool : YC-160R (J.S.T)

*Connector for Remote ON/OFF control: CN3 (J.S.T)

Connector	Housing	Recommended
		Terminal Pin
B2B - XH - A	XHP - 2	BXH - 001T - P0.6 or SXH - 001T - P0.6

*CN3 is normally shorted by JM-2W-96 (J.S.T)

*Hand Crimping Tool: YC-110R (J.S.T) or YRS-110 (J.S.T)

1-3. ZWD225PAF/T

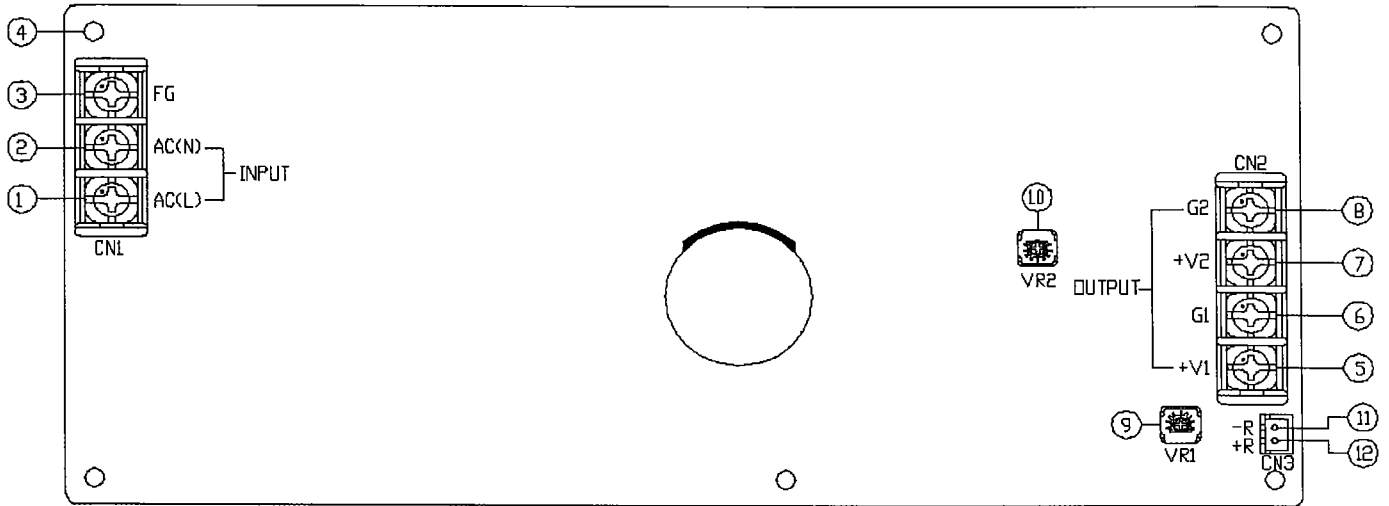

- ① L: AC Input terminal L (M4 screw)
Live line (fuse in line)
- ② N: AC input terminal N (M4 screw)
Neutral line
- ③ FG: Input terminal FG (M4 screw)
Safety earth (Frame Ground)
Connect to safety ground of apparatus or equipment.
- ④ FG: Frame Ground
Must be connected to electrically safety ground of apparatus or equipment by electrically conductive spacers. The mounting surface of the spacer should be within MAX $\phi 8\text{mm}$.
- ⑤ V1: CH1 +ve Output terminal
- ⑥ G1: CH1 -ve Output terminal
- ⑦ V2: CH2 +ve Output terminal
- ⑧ G2: CH2 -ve Output terminal
- ⑨ V.ADJ: 5V Output Voltage adjust trimmer (VR1)
The 5V Output voltage rises when the trimmer is turned clockwise.
- ⑩ V.ADJ : 24V Output Voltage adjust trimmer (VR2)
The 24V Output voltage rises when the trimmer is turned clockwise.

- ⑪ -R : CN3 ON/OFF control -R terminal
- ⑫ +R : CN3 ON/OFF control +R terminal

* Input & Output connector (EMUDEN)
(also for option model /TL,/TA)

	Connector
Input (CN1)	T6957-A
Output (CN2)	T6958-A

*Connector for Remote ON/OFF control: CN3 (J.S.T)

Connector	Recommended	
	Housing	Terminal Pin
B2B - XH - A	XHP - 2	BXH - 001T - P0.6 or SXH - 001T - P0.6

*CN3 is normally shorted by JM-2W-96 (J.S.T)

*Hand Crimping Tool: YC-110R (J.S.T) or YRS-110 (J.S.T)

2. Terminal Connecting Method

Pay attention to the input wiring. If it is connected to the wrong terminal, the power supply will be damaged.

- Input must be turned off when making connections.
- Connect FG terminal of input connector and mountable FG to ground terminal of the equipment.
- Output current of each connector pin must be less than 5A. (Except /T model which M4 screw is used.)
- The output load line and input line shall be separated and twisted to improve noise sensitivity.
- Remote ON/OFF control lines shall be twisted or use shielded wire.
- Use recommended input/output connector housing, terminal pin & crimping tool.
Connector housing and terminal pin is not included with this product.
- When connecting or removing connector, do not apply stress to PCB.

ZWD225PAF

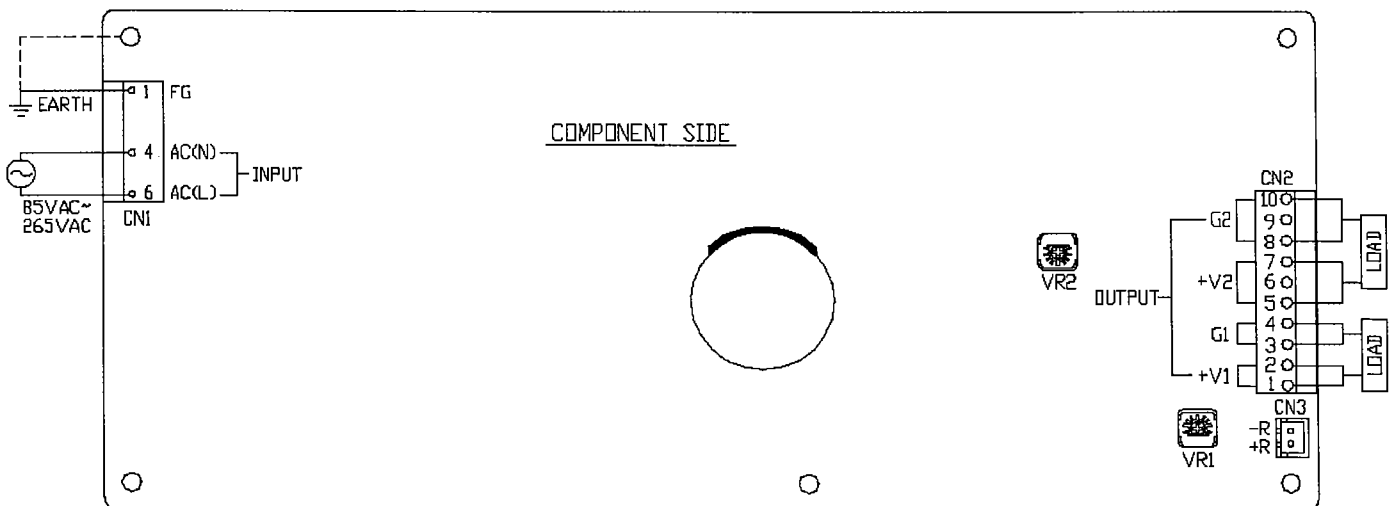

ZWD225PAF/J

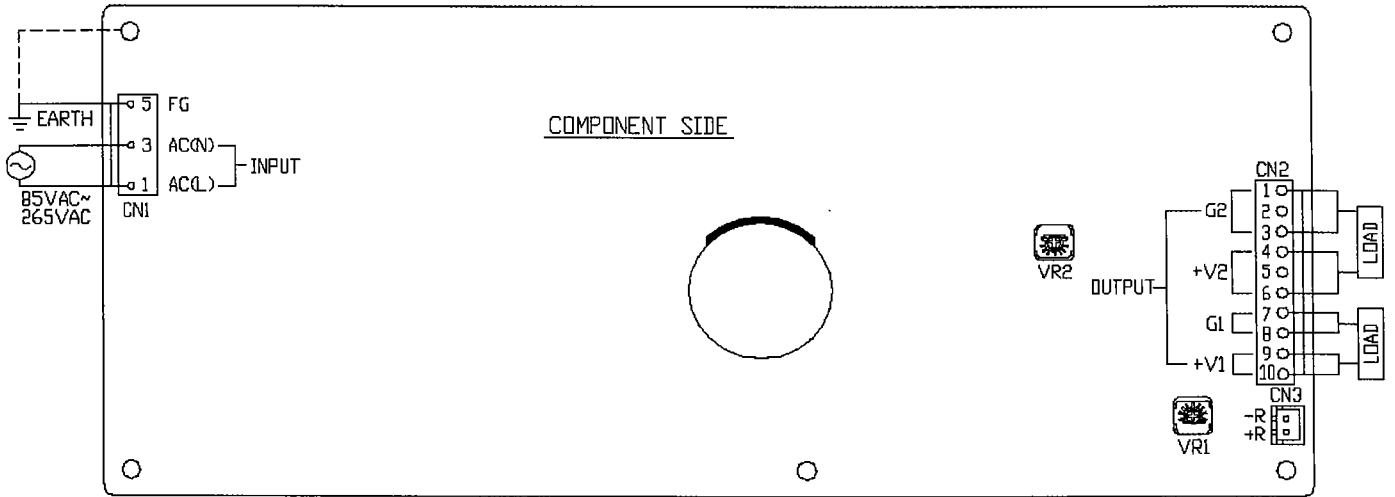

ZWD225PAF/T

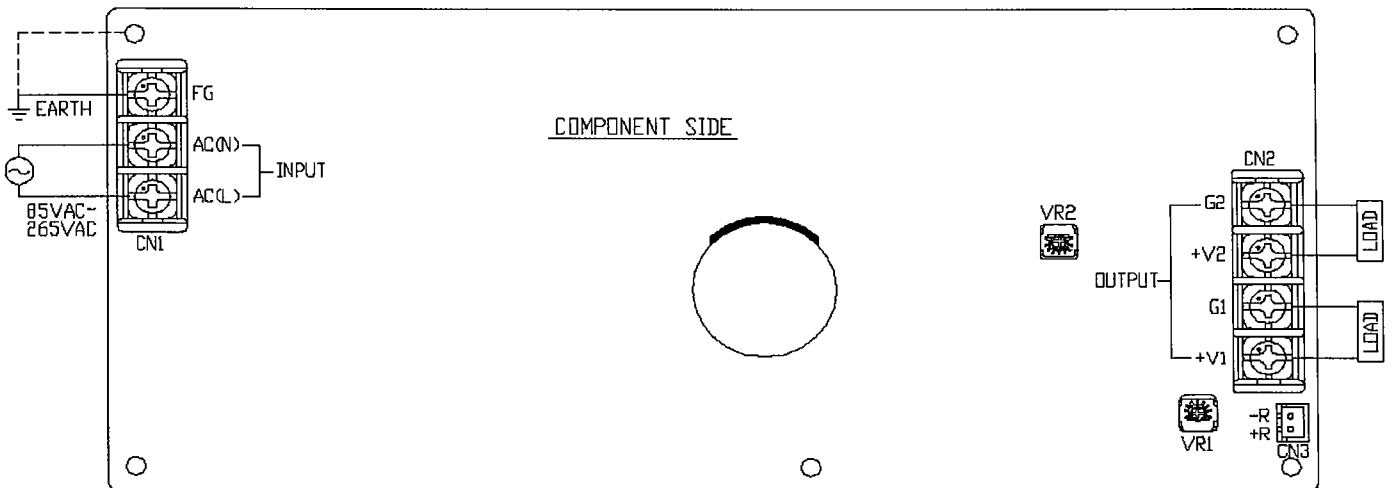

3. Explanation of Function and Precautions

3-1. Input Voltage Range

Input voltage range is single phase 85 ~ 265VAC (47 ~ 63Hz) or 120 ~ 370VDC. Input voltage which is out of specification may damage unit. For cases where conformance to various safety specs(UL,CSA,EN) are required, input voltage range will be 100 ~ 240VAC (50/60Hz).

3-2. Output Voltage Range

V.ADJ trimmer (VR1 & VR2) which is nearby to output connector is for output voltage adjustment. Please refer to the specifications for the output adjustment range. When the trimmer is turned clockwise, the output voltage will increase. Note that over voltage protection (OVP) function may trigger if the output voltage is increased excessively.

3-3. Inrush Current

This series used Power Thermistor to protect the circuit from Inrush Current. Please carefully select input switch and fuse in cases of high temperature and brown-out.

3-4. Over Voltage Protection (OVP)

OVP circuit will shutdown output correspondingly. OVP for V1, both V1 & V2 will shutdown, OVP for V2, only V2 shutdown. Manual reset or input voltage recycling is needed for output recovery.

3-5. Over Current Protection (OCP)

OCP type is constant current limiting with automatic recovery. OCP function operates when the output current exceeds OCP specifications. The output will automatically recover when the overload condition is removed. Do not operate overload or dead short conditions for more than 30 seconds, which could result in damage or insulation failure.

3-6. Over Temperature Protection (OTP)

OTP circuit is built into the power supply to prevent user from fire hazard when ambient temperature is over the specification.

3-7. Output Ripple & Noise

The standard specification for maximum ripple and noise value is measured according to measurement circuit specified below. When load lines are longer, ripple and noise may become larger. In this case, electrolytic capacitor, film capacitor, etc. might be necessary across the load terminal. The output ripple and noise cannot be measured accurately if the oscilloscope probe ground lead is too long.

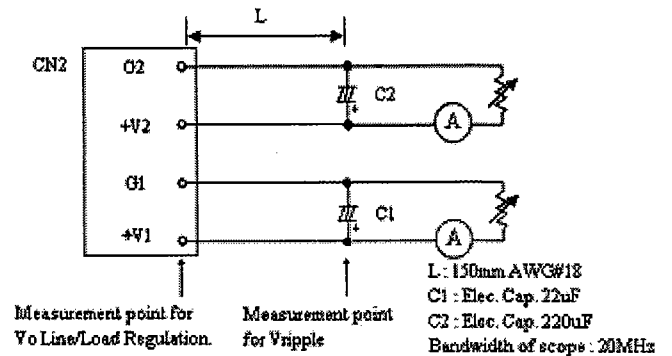

3-8. Series Operation

Series operation is not possible.

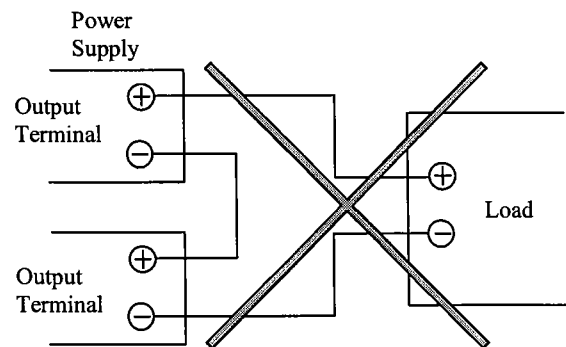

3-9. Parallel Operation

Paralled operation is not possible.

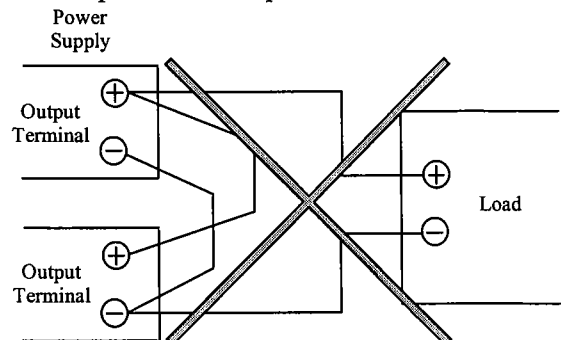

3-10. Peak Output Current

For ZWD225PAF series, the peak output current should satisfy the conditions below:

- 1) Should not exceed the rated peak current in the specification. (eg. 14/18A respectively for 100VAC/200VAC)
- 2) The relation between peak output current with average output current is defined as below.

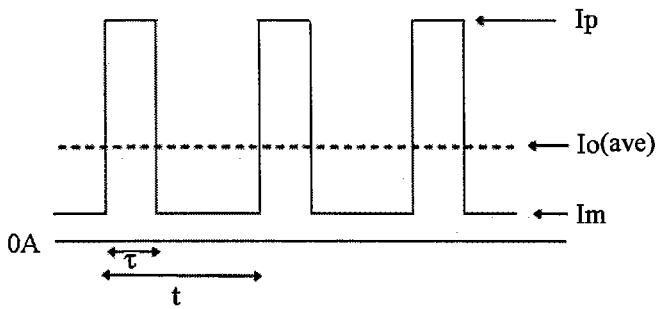

- I_p = Peak output current
- I_m = Minimum output current
- D = Duty cycle, τ/T
- τ = Peak output current operating time
- T = Period
- I_o = Maximum allowable average output current of specifications (I_o should be average load after derating at various mounting and ambient temperature)

- 3) For peak output current ($I_p \leq 14A$) at 100VAC & 200VAC, the duty cycle of the peak output current is $\leq 35\%$ and operating time of the peak output current is less than 10 seconds. For peak output current ($I_p \leq 18A$) at 200VAC only, the duty cycle of the peak output current is $\leq 20\%$ and operating time of the peak output current is less than 5 seconds. Maximum ambient has to be reduced by $10^\circ C$ if 35% duty operation is required.

V_{in} (VAC)	I_p (max)	Duty(max)	τ (sec)
85 ~ 132	14A	35%	10sec
170 ~ 265	14A	35%	10sec
170 ~ 265	18A	20%	5sec

4) Formula:

$$\text{ZWD225PAF: } I_o(\text{ave}) = I_p \times D + I_m \times (1-D) \leq I_o \text{ spec.}$$

(refer to derating curve)

Example : For ZWD225PAF-0524 at $T_a = 60^\circ C$, Mounting A,
 Max $I_o(\text{ave}) = 4.5A$ (after 50% Derating)

$$I_o(\text{ave}) = I_p \times D + I_m \times (1-D) \leq I_o \text{ spec.}$$

(A) 100VAC : In case of $I_m = 0, I_p = 14A,$
 $D \leq 32\%$

(B) 200VAC : In case of $I_m = 2A, I_p = 18A,$
 $D \leq 15\%$

3-11. Remote ON/OFF Control

Remote ON/OFF control (CN3) function is available. Using this function allows the user to turn the 24V output on and off without having to turn the AC input on and off.

It is controlled by short or open between +R & -R of CN3. CN3 is provided in the secondary circuit for ON/OFF control by means of a switch or other device.

[CN3] The control mode is shown below.

+R & -R Terminal condition	Output condition of V2
Short < 0.5V	ON
Open > 4.5V	OFF

3-12. Isolation Test

Isolation resistance between output and FG (Chassis) shall be more than $100M\Omega$ at 500VDC. For safety operation, voltage setting of DC isolation tester must be done before the test. Ensure that it is fully discharged after the test.

Output – FG (Chassis)
 500VDC $100M\Omega$ or more

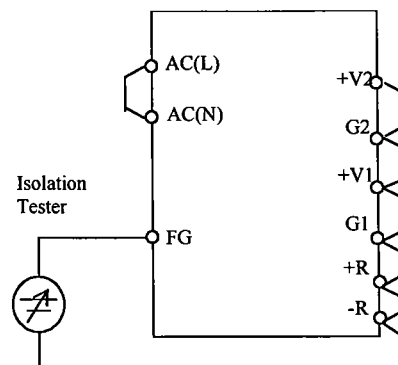

3-13. Withstand Voltage

This series is designed to withstand 3.0kVAC between input and output, 2.0kVAC between input and FG (Chassis) and 500VAC between output and the FG (Chassis) each for 1 minute. When performing this test, set current limit of the withstand voltage test equipment to 20mA (Output - FG (Chassis) : 100mA). The applied voltage must be gradually increased from zero to the test value and then gradually decreased for shut down. When timer is used, the power supply may be damaged by high impulse voltage during timer switch on and off. Connect input and output as follows.

- Input ~ Output (dotted line)
 3kVAC 1min. (20mA)
- Input ~ FG (Chassis) (solid line)
 2kVAC 1min. (20mA)

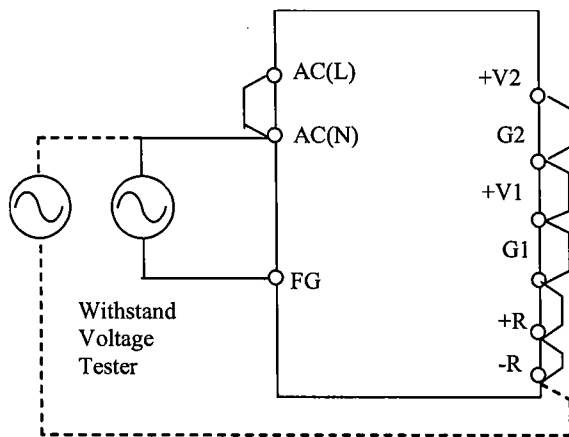

- Output ~ FG (Chassis)
 500VAC 1min. (100mA)

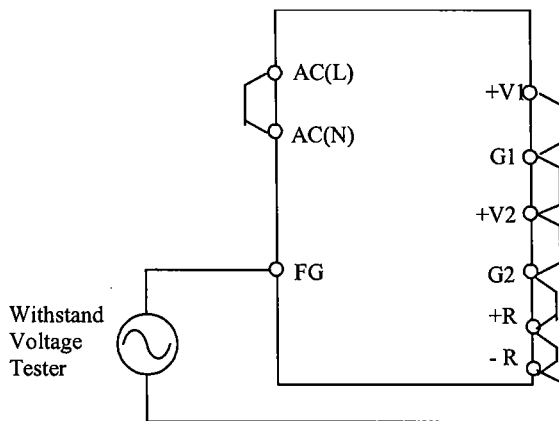

4. Mounting Directions

4-1. Output Derating according to the Mounting Directions

Recommended standard mounting method is (A). Method (B), (C), (D), (E) are also possible. Mounting (F), (G), (H), (I) are prohibited. Refer to the derating curve, average load(%) is percent of maximum output load (both Maximum Output Current and Maximum Output Power in specifications). Do not exceed the load deratings.

PCB type

(A)
Standard Mounting

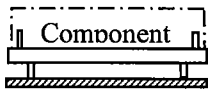

(B)
Input

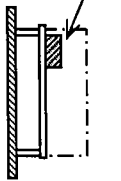

(C)

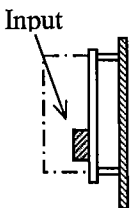

(D)
Input
Output

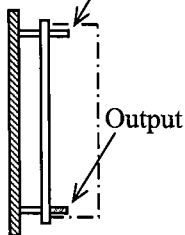

(E)

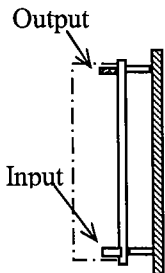

(F)
Prohibit

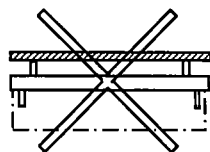

With chassis and with chassis&cover type mounting method

(A)
Standard Mounting

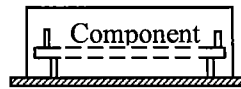

(B)

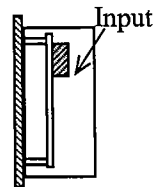

(C)

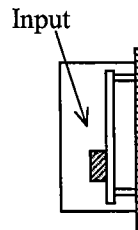

(D)

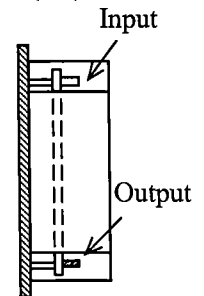

(E)

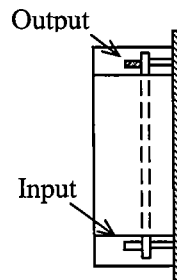

(F)
Prohibit

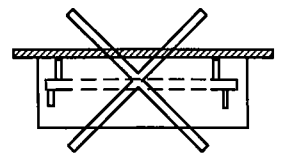

(G)
Prohibit

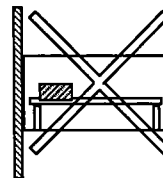

(H)
Prohibit

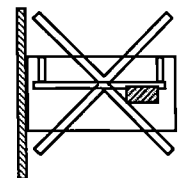

(I)
Prohibit

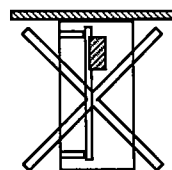

Output Derating

- Convection cooling

PCB type and with chassis type

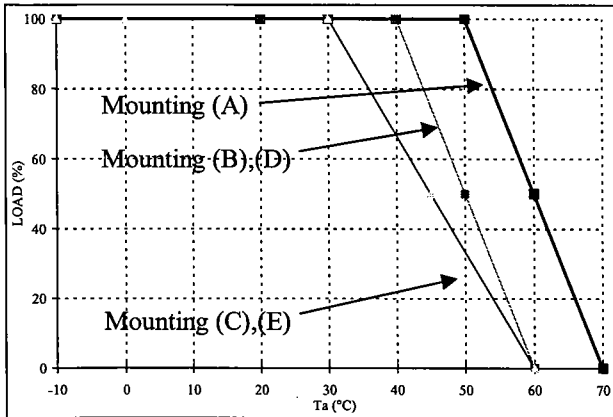

Convection		Average Load (%)		
Mounting		A	B,D	C,E
Ta	Mounting			
-10~ 30°C		100	100	100
40°C		100	100	66
50°C		100	50	33
60°C		50	0	0
70°C		0	-	-

With chassis and cover type

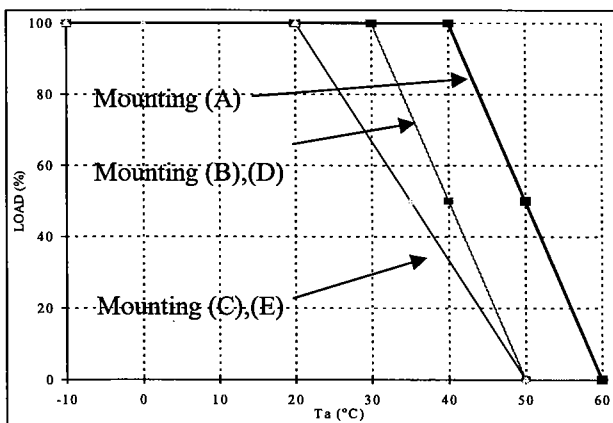

Convection		Average Load (%)		
Mounting		A	B,D	C,E
Ta	Mounting			
-10~ 20°C		100	100	100
30°C		100	100	67
40°C		100	50	33
50°C		50	0	0
60°C		0	-	-

- Forced air cooling
PCB type and with chassis type

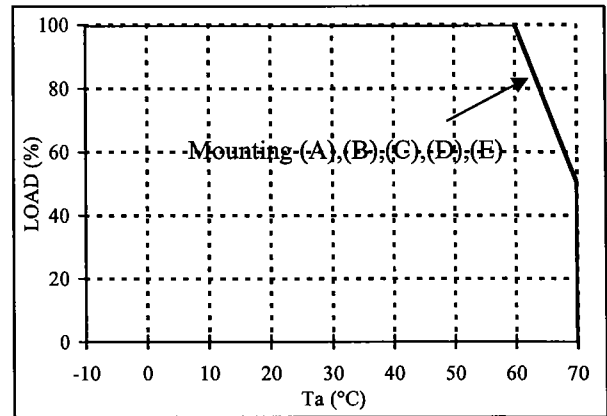

Forced air		Average Load (%)
Mounting		A,B,C,D,E
Ta	Mounting	
-10~ 60°C		100
70°C		50

With chassis and cover type

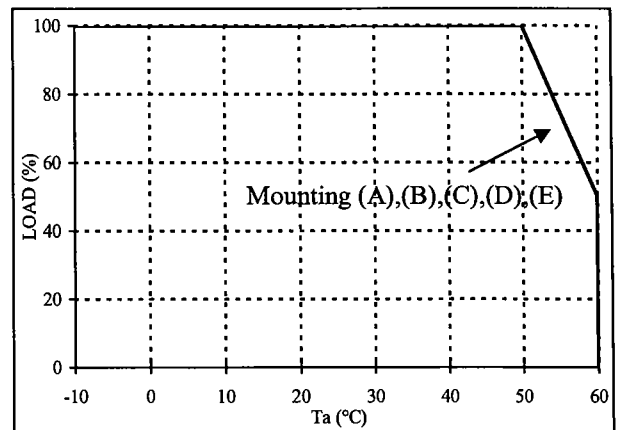

Forced air		Average Load (%)
Mounting		A,B,C,D,E
Ta	Mounting	
-10~ 50°C		100
60°C		50

*Recommended minimum air velocity : 0.7m/s
(Measured at component side of PCB, air must flow through component side).

4-2. Mounting Method

PCB type

Please use the mounting holes (5 holes of $\phi 3.5$) and insert the spacer (MAX $\phi 8.0$) of height over 8mm to lift the unit. Also use all 5 mounting holes for the unit installation. The vibration test is taken when the unit is raised by 8mm spacers.

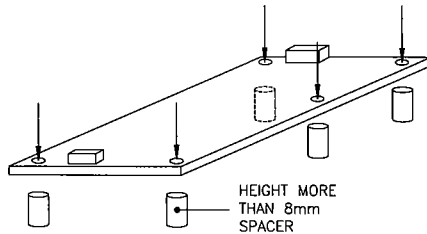

Please leave 4.5mm space from the unit surfaces and leave 4.5mm space from the sides of PCB. For the solder surface, 8mm space is necessary. If the space is not enough, the specification for insulation and withstand voltage will not be satisfied.

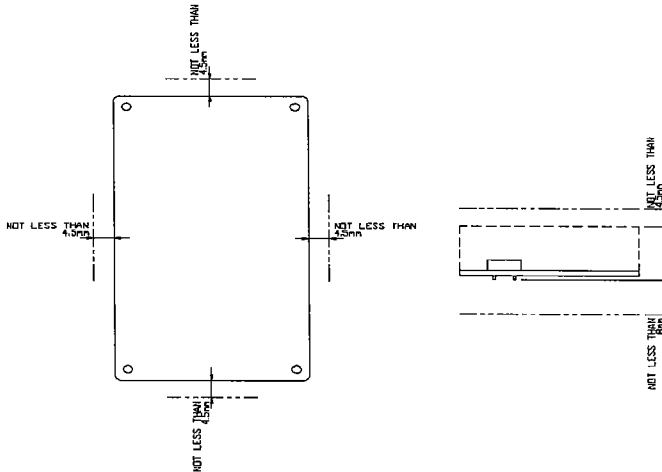

FG should be connected to the earth terminal of the apparatus. If not, the EMI noise and output noise will increase.

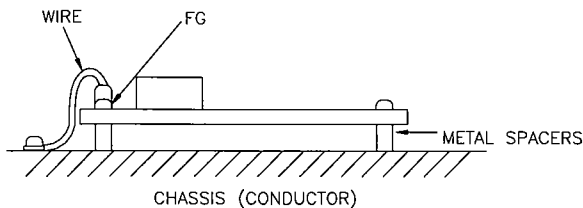

Hatching area is maximum permissible area of metal part for mounting.

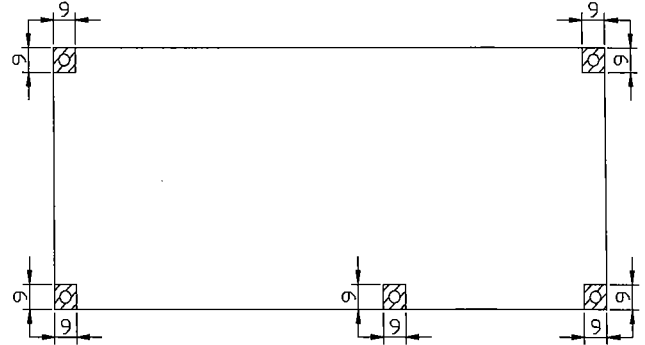

For chassis option /L, chassis & cover option /A

Recommended mounting by following holes A or B, to meet 19.6m/s^2 vibration specification. Mounting direction (F) & (G) is prohibited as shown in section 4-1.

- A: Embossed tapped and countersunk holes by 4-M4 screws
- B: $\phi 4.5$ holes and R2.25 slot hole by 3-M4 screws

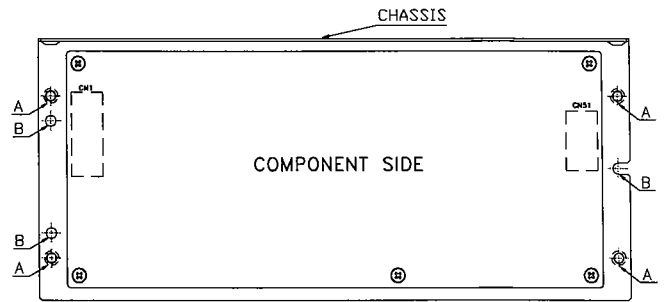

Mounting (F), (G), (H), (I) is prohibited.

For mounting method (J), (K), (L), below, the vibration specification is 4.9m/s^2 , mounted through holes C or D.

Note: Output derating for mounting (J) is same as mounting (C). Output derating for mounting (K) is same as mounting (E). Output derating for mounting (L) is same as mounting (D).

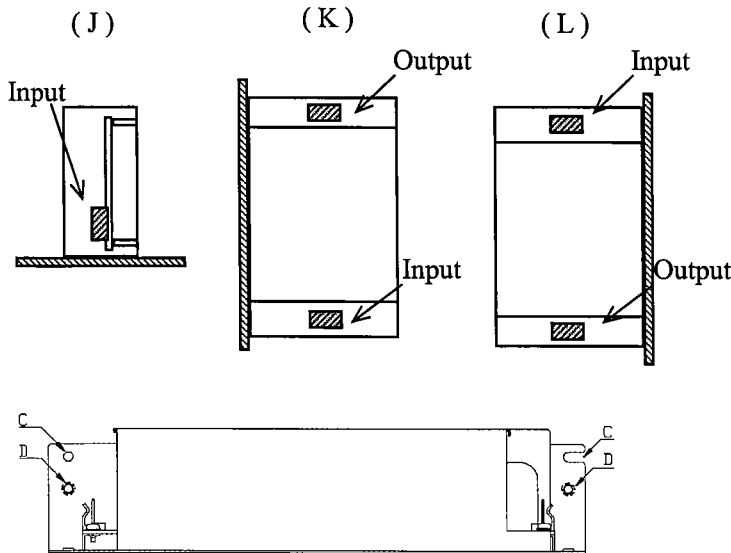

C: 1- Φ 4.5 holes and R2.25 slot hole by 2-M4 screws
 D: Embossed tapped and countersunk holes by 2-M4 screws.

5. Wiring Method

- The output load line and input line shall be separated and twisted to improve noise sensitivity.
- Use all lines as thick and short as possible to have lower impedance.
- Noise can be eliminated by attaching a capacitor to the load terminals.
- For safety and EMI considerations, connect FG terminal of input connector and mountable FG to ground terminal of equipment.
- Recommended screw torque is 0.49N.m (5kg.cm)
- Select the wire materials to adapt to the MOLEX and J.S.T connector as follows.
 INPUT : AWG#22 ~ #18
 OUTPUT : AWG#22 ~ #18

6. External Fuse Rating

Refer to the following fuse rating when selecting the external fuses that are to be used on input line. Surge current flows when line is turned on. Use slow-blow fuse or time-lag type fuse. Do not use fast-blow fuse. Fuse rating is specified by in-rush current value at line turn-on. Do not select the fuse according to input current (rms) values under the actual load condition.

ZWD225PAF : 6.3A

7. Before concluding that the unit is at fault...

Before concluding that the unit is at fault, make the following checks.

- Check if the rated input voltage is connected.
- Check if the wiring of input and output is correct.
- Check that the wire material is not too thin.
- Check if the output voltage control (V.ADJ) is properly adjusted.
- If you use the Remote ON/OFF control function, make sure the Remote ON/OFF control connector is not opened.
- Check that the output current and output wattage is not over specification.
- Audible noise may be heard during Dynamic-Load operation.
- Audible noise may be heard when input voltage waveform is not sinusoidal wave.

8. Repair

In case of damage of this product, please return to our service center or factory.