



Main

Range of product	Harmony XB4
Product or component type	Head for illuminated selector switch
Product compatibility	Integral LED
Device short name	ZB4F
Bezel material	Chromium plated metal
Head type	Built-in-flush
Mounting diameter	30.5 mm
Sale per indivisible quantity	1
Shape of signaling unit head	Round
Type of operator	Spring return right to centre
Operator profile	Yellow standard handle
Operator position information	3 positions +/- 45°

Complementary

CAD overall width	36.6 mm
CAD overall height	36.6 mm
CAD overall depth	47 mm
Product weight	0.078 kg
Resistance to high pressure washer	7000000 Pa at 55 °C, distance: 0.1 m
Mechanical durability	500000 cycles
Electrical composition code	M6 for 2 contacts using single blocks in front mounting with integral LED and transformer M10 for 2 contacts using single blocks in front mounting with integral LED M3 for 4 contacts using single blocks in front mounting with integral LED M4 for 4 contacts using single and double blocks in front mounting with integral LED

Environment

protective treatment	TH
ambient air temperature for storage	-40...70 °C
ambient air temperature for operation	-40...70 °C
overvoltage category	Class I conforming to IEC 60536
IP degree of protection	IP67 IP66 conforming to IEC 60529 IP69K IP69
NEMA degree of protection	NEMA 13 NEMA 4X
IK degree of protection	IK06 conforming to IEC 50102
standards	EN/IEC 60947-1 EN/IEC 60947-5-1 EN/IEC 60947-5-4 JIS C 4520 UL 508 CSA C22.2 No 14
product certifications	CSA UL listed
vibration resistance	5 gn (f = 2...500 Hz) conforming to IEC 60068-2-6
shock resistance	30 gn (duration = 18 ms) for half sine wave acceleration conforming to IEC 60068-2-27 50 gn (duration = 11 ms) for half sine wave acceleration conforming to IEC 60068-2-27

The information provided in this documentation contains general descriptions and/or technical characteristics of the performance of the products contained herein. This documentation is not intended as a substitute for and is not to be used for determining suitability or reliability of these products for specific user applications. It is the duty of any such user or integrator to perform the appropriate and complete risk analysis, evaluation and testing of the products with respect to the relevant specific application or use thereof. Neither Schneider Electric Industries SAS nor any of its affiliates or subsidiaries shall be responsible or liable for misuse of the information contained herein.

Offer Sustainability

Sustainable offer status	Green Premium product
RoHS (date code: YYWW)	Compliant - since 1804 - Schneider Electric declaration of conformity
REACH	Reference not containing SVHC above the threshold
Product environmental profile	Available
Product end of life instructions	Need no specific recycling operations

Contractual warranty

Warranty period	18 months
-----------------	-----------

Dimensions

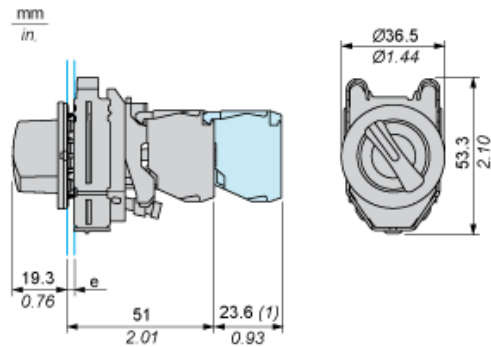

e : clamping thickness: 1 to 6 mm / 0.04 to 0.24 in.

(1) : Additional row of contacts

Panel Cut-out for Pushbuttons, Switches and Pilot Lights (Finished Holes, Ready for Installation)

Connection by Screw Clamp Terminals or Plug-in Connectors

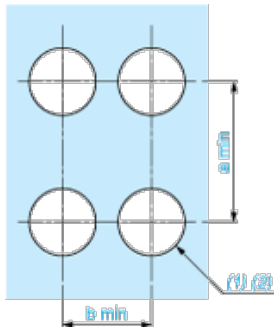

(1) : Diameter on finished panel or support

(2) : $\varnothing 30.75$ mm recommended ($\varnothing 30.5_{0}^{+0.5}$) / $\varnothing 1.21$ in. recommended ($\varnothing 1.20$ in. $_{0}^{+0.0196}$)

Connections	a in mm	a in in.	b in mm	b in in.
By connectors	50	1.97	40	1.57
By connectors and with legend holder ZBZF32	50	1.97	40	1.57
By connectors and with legend holder ZBZF33	60	2.36	40	1.57

Electrical Composition Corresponding to Code M3

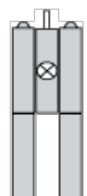

Electrical Composition Corresponding to Code M4



Electrical Composition Corresponding to Codes M6 and P2

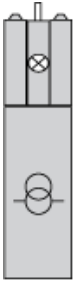

Electrical Composition Corresponding to Codes M5, M10, MF1, MR1 and MF2



Legend

Single contact



Double contact



Light block







Possible location



Sequence of Contacts Fitted to 3-position Selector Switch Body





Position 315°



Push	Position	Top			
		Bottom			
	Location		Left		Right
	State		1		0
	Contacts	N/O			closed
N/C		open	closed		





Position 0°



Push	Position	Top			
		Bottom			
	Location		Left		Right
	State		0		0
	Contacts	N/O			open
N/C		closed	closed		

Position 45°



Push	Position	Top			
		Bottom			
	Location		Left		Right
	State		0		1
	Contacts	N/O			open
N/C		closed	open		