







power contactor AC-1 900 A / 690 V / 40 °C 3-pole, U<sub>c</sub>: 110-127 V AC(50-60 Hz) / 100-110 V DC, drive: conventional auxiliary contacts 2 NO + 2 NC main circuit: busbar control and auxiliary circuit: screw terminal

<b>product brand name</b>	SIRIUS
<b>product designation</b>	Contacteur
<b>product type designation</b>	3RT14
<b>General technical data</b>	
<b>product extension</b>	
• function module for communication	No
• auxiliary switch	Yes
<b>power loss [W] for rated value of the current</b>	
• at AC in hot operating state	300 W
• at AC in hot operating state per pole	100 W
• without load current share typical	6 W
<b>type of calculation of power loss depending on pole</b>	quadratic
<b>insulation voltage</b>	
• of main circuit with degree of pollution 3 rated value	1 000 V
• of auxiliary circuit with degree of pollution 3 rated value	600 V
<b>surge voltage resistance</b>	
• of main circuit rated value	8 kV
• of auxiliary circuit rated value	6 kV
<b>shock resistance with sine pulse</b>	
• at AC	8g / 11 ms
• at DC	8g / 11 ms
<b>mechanical service life (operating cycles)</b>	
• of contactor typical	1 000 000
<b>Substance Prohibition (Date)</b>	03/27/2020
<b>SVHC substance name</b>	Lead - 7439-92-1
<b>Net Weight</b>	23.569 kg
<b>Ambient conditions</b>	
installation altitude at height above sea level maximum	2 000 m
<b>ambient temperature</b>	
• during operation	-25 ... +55 °C
• during storage	-40 ... +80 °C
<b>relative humidity minimum</b>	10 %
<b>relative humidity at 55 °C according to IEC 60068-2-30 maximum</b>	95 %
<b>Main circuit</b>	
<b>number of poles for main current circuit</b>	3
<b>number of NO contacts for main contacts</b>	3
<b>number of NC contacts for main contacts</b>	0
<b>type of voltage for main current circuit</b>	AC

<b>operational current</b>	
<ul style="list-style-type: none"> <li>● at AC-1 <ul style="list-style-type: none"> <li>— up to 690 V at ambient temperature 40 °C rated value</li> <li>— up to 690 V at ambient temperature 55 °C rated value</li> <li>— up to 1000 V at ambient temperature 40 °C rated value</li> <li>— up to 1000 V at ambient temperature 55 °C rated value</li> </ul> </li> </ul>	<p>900 A</p> <p>900 A</p> <p>900 A</p> <p>900 A</p>
minimum cross-section in main circuit at maximum AC-1 rated value	600 mm <sup>2</sup>
<b>no-load switching frequency</b>	
<ul style="list-style-type: none"> <li>● at AC</li> <li>● at DC</li> </ul>	<p>600 1/h</p> <p>600 1/h</p>
operating frequency at AC-1 maximum	600 1/h
<b>Control circuit/ Control</b>	
<b>type of voltage of the control supply voltage</b>	AC/DC
<b>control supply voltage at AC</b>	
<ul style="list-style-type: none"> <li>● at 50 Hz rated value</li> <li>● at 60 Hz rated value</li> </ul>	<p>100 ... 127 V</p> <p>100 ... 127 V</p>
<b>control supply voltage at DC rated value</b>	100 ... 110 V
<b>operating range factor control supply voltage rated value of magnet coil at DC</b>	
<ul style="list-style-type: none"> <li>● initial value</li> <li>● full-scale value</li> </ul>	<p>0.85</p> <p>1.1</p>
<b>operating range factor control supply voltage rated value of magnet coil at AC</b>	
<ul style="list-style-type: none"> <li>● at 50 Hz</li> <li>● at 60 Hz</li> </ul>	<p>0.85 ... 1.1</p> <p>0.85 ... 1.1</p>
<b>design of the surge suppressor</b>	with varistor
<b>apparent pick-up power of magnet coil at AC</b>	
<ul style="list-style-type: none"> <li>● at 50 Hz</li> <li>● at 60 Hz</li> </ul>	<p>1 000 VA</p> <p>1 000 VA</p>
<b>apparent holding power of magnet coil at AC</b>	
<ul style="list-style-type: none"> <li>● at 50 Hz</li> <li>● at 60 Hz</li> </ul>	<p>18 VA</p> <p>18 VA</p>
<b>closing power of magnet coil at DC</b>	1 400 W
<b>holding power of magnet coil at DC</b>	6 W
<b>closing delay</b>	
<ul style="list-style-type: none"> <li>● at AC</li> <li>● at DC</li> </ul>	<p>80 ms</p> <p>80 ms</p>
<b>opening delay</b>	
<ul style="list-style-type: none"> <li>● at AC</li> <li>● at DC</li> </ul>	<p>70 ms</p> <p>70 ms</p>
<b>control version of the switch operating mechanism</b>	Standard A1 - A2
<b>Auxiliary circuit</b>	
<b>number of NC contacts for auxiliary contacts</b>	2
<ul style="list-style-type: none"> <li>● attachable</li> <li>● instantaneous contact</li> </ul>	<p>4</p> <p>2</p>
<b>number of NO contacts for auxiliary contacts</b>	2
<ul style="list-style-type: none"> <li>● attachable</li> <li>● instantaneous contact</li> </ul>	<p>4</p> <p>2</p>
operational current at AC-12 maximum	16 A
<b>operational current at AC-15</b>	
<ul style="list-style-type: none"> <li>● at 230 V rated value</li> <li>● at 400 V rated value</li> <li>● at 500 V rated value</li> </ul>	<p>3 A</p> <p>1.5 A</p> <p>1.4 A</p>
<b>operational current at DC-13</b>	
<ul style="list-style-type: none"> <li>● at 48 V rated value</li> <li>● at 60 V rated value</li> </ul>	<p>2 A</p> <p>2 A</p>

<ul style="list-style-type: none"> <li>• at 110 V rated value</li> <li>• at 125 V rated value</li> <li>• at 220 V rated value</li> <li>• at 600 V rated value</li> </ul>	<p>1 A</p> <p>0.55 A</p> <p>0.27 A</p> <p>0.1 A</p>	
<b>Short-circuit protection</b>		
<b>design of the fuse link</b> <ul style="list-style-type: none"> <li>• for short-circuit protection of the main circuit <ul style="list-style-type: none"> <li>— with type of coordination 2 required</li> </ul> </li> <li>• for short-circuit protection of the auxiliary switch required</li> </ul>	<p>aR: 1000 A (1000 V, 30 kA)</p> <p>gG: 16 A (600 V, 1 kA)</p>	
<b>Installation/ mounting/ dimensions</b>		
<b>mounting position</b>	+/-30° rotation possible on vertical mounting surface; can be tilted forward and backward by +/- 30° on vertical mounting surface	
fastening method side-by-side mounting	No	
<b>fastening method</b>	screw fixing	
<b>height</b>	352 mm	
<b>width</b>	285 mm	
<b>depth</b>	250 mm	
<b>required spacing</b> <ul style="list-style-type: none"> <li>• for grounded parts <ul style="list-style-type: none"> <li>— forwards</li> <li>— at the side</li> </ul> </li> </ul>	<p>125 mm</p> <p>75 mm</p>	
<b>net weight</b>	22 kg	
<b>Connections/ Terminals</b>		
<b>type of electrical connection</b> <ul style="list-style-type: none"> <li>• for main current circuit</li> <li>• for auxiliary and control circuit</li> <li>• at contactor for auxiliary contacts</li> <li>• of magnet coil</li> </ul>	<p>busbar connection</p> <p>screw-type terminals</p> <p>Screw-type terminals</p> <p>Screw-type terminals</p>	
<b>width of connection bar</b>	40 mm	
<b>thickness of connection bar</b>	10 mm	
<b>diameter of holes</b>	17 mm	
<b>connectable conductor cross-section for auxiliary contacts</b> <ul style="list-style-type: none"> <li>• solid or stranded</li> <li>• finely stranded with core end processing</li> </ul>	<p>1 ... 2.5 mm<sup>2</sup></p> <p>1 ... 2.5 mm<sup>2</sup></p>	
<b>type of connectable conductor cross-sections</b> <ul style="list-style-type: none"> <li>• for auxiliary contacts <ul style="list-style-type: none"> <li>— solid</li> <li>— solid or stranded</li> <li>— finely stranded with core end processing</li> </ul> </li> <li>• for AWG cables for auxiliary contacts</li> </ul>	<p>2x (1 ... 2,5 mm<sup>2</sup>)</p> <p>2x (1 ... 2.5 mm<sup>2</sup>)</p> <p>2x (1 ... 2,5 mm<sup>2</sup>)</p> <p>2x (16 ... 14)</p>	
<b>AWG number as coded connectable conductor cross section for auxiliary contacts</b>	16 ... 14	
<b>Safety related data</b>		
<b>product function</b> <ul style="list-style-type: none"> <li>• mirror contact according to IEC 60947-4-1</li> <li>• positively driven operation according to IEC 60947-5-1</li> </ul>	<p>Yes</p> <p>No</p>	
<b>service life maximum</b>	20 a	
Electrical Safety		
<b>protection class IP on the front according to IEC 60529</b>	IP00	
<b>Approvals Certificates</b>		
<b>Environment</b>	<b>General Product Approval</b>	
<a href="#">Environmental Conformations</a>	    	
<b>EMV</b>	<b>other</b>	<b>Railway</b>



[Confirmation](#)

[Miscellaneous](#)

[Special Test Certificate](#)

#### Further information

##### Information on the packaging

<https://support.industry.siemens.com/cs/ww/en/view/109813875>

##### Information for data generation and storage

<https://support.industry.siemens.com/cs/ww/en/view/109995012>

##### Information- and Downloadcenter (Catalogs, Brochures,...)

<https://www.siemens.com/ic10>

##### Industry Mall (Online ordering system)

<https://mall.industry.siemens.com/mall/en/en/Catalog/product?mlfb=3RT1481-6AF36>

##### Service&Support (Manuals, Certificates, Characteristics, FAQs,...)

<https://support.industry.siemens.com/cs/ww/en/ps/3RT1481-6AF36>

##### Image database (product images, 2D dimension drawings, 3D models, device circuit diagrams, EPLAN macros, ...)

[https://www.automation.siemens.com/bilddb/cax\\_de.aspx?mlfb=3RT1481-6AF36&lang=en](https://www.automation.siemens.com/bilddb/cax_de.aspx?mlfb=3RT1481-6AF36&lang=en)

##### Cax online generator

<https://support.automation.siemens.com/WW/CAXorder/default.aspx?lang=en&mlfb=3RT1481-6AF36>

##### Characteristic curves

[https://curves.simaris.siemens.com/curves/<mmp\\_prod\\_noCOMP="HAUPT"></mmp\\_prod\\_no>](https://curves.simaris.siemens.com/curves/<mmp_prod_noCOMP="HAUPT"></mmp_prod_no>)

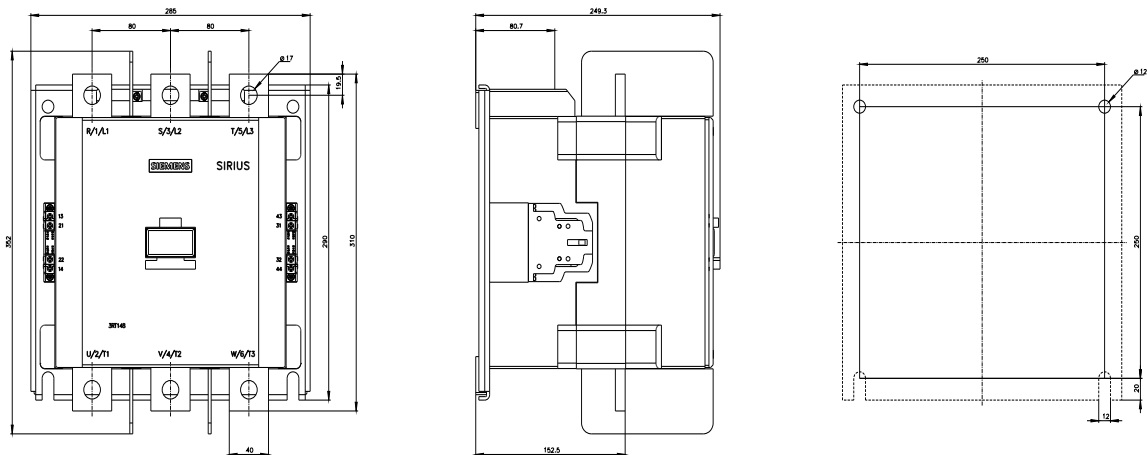

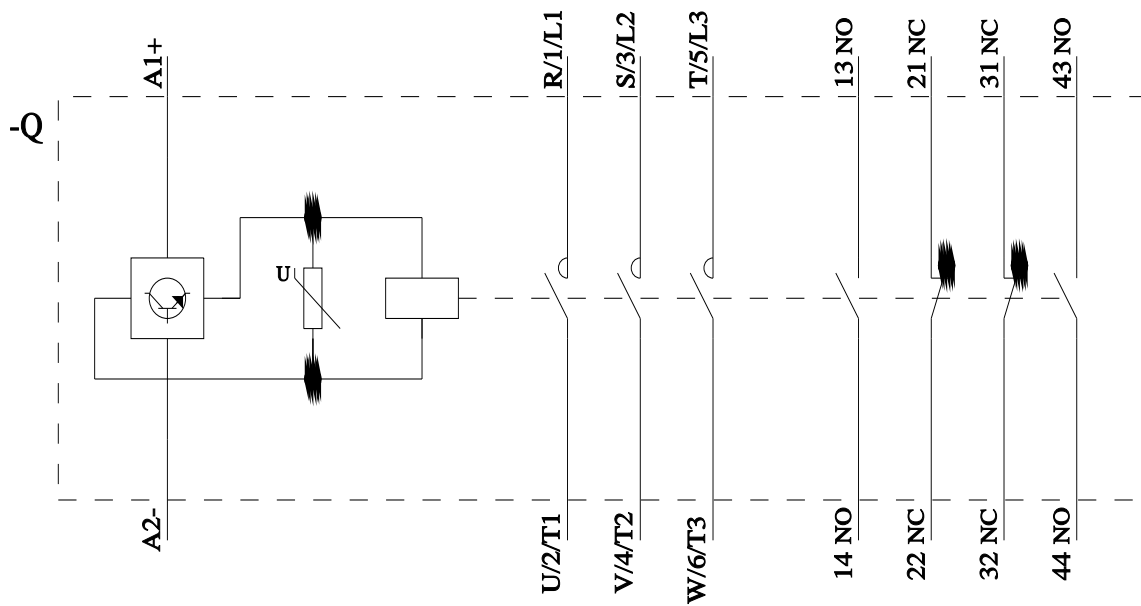

last modified:

12/16/2025 