



SMT Power Inductors

ERU 20, helically wound

Series/Type: B82559*A020

Ordering code:

Date: June 2012

Rated inductance 1 ... 35 μ H
Saturation current 9.3 ... 50.0 A

Construction

- High temperature ferrite core
- Magnetically shielded
- Helical winding
- Self-leded construction under body termination



Features

- High rated current
- Extremely low DC resistance
- Very low profile and smallest possible footprint
- RoHS-compatible
- Easily customized
- Suitable for pick-and-place processes

Applications

Energy storage chokes for

- DC/DC converters
- VRM modules
- POL converters
- Solar converters

Terminals

- Lead-free tinned

Marking

- Manufacturer, ordering code, inductance
 manufacturing date, coded (yyww)

Delivery mode and packing units

- Blister tape
- Reel

Dimensional Drawing and layout recommendation

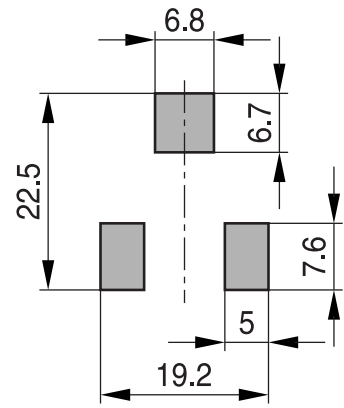
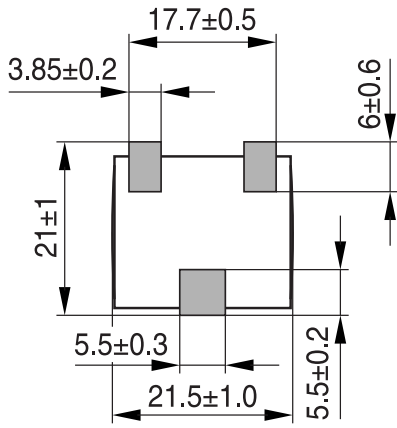

IND1057-H

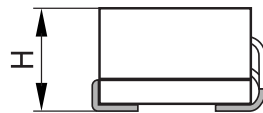
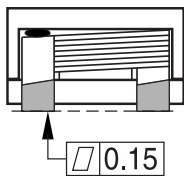

IND1056-B

Taping and packing

Blister tape:

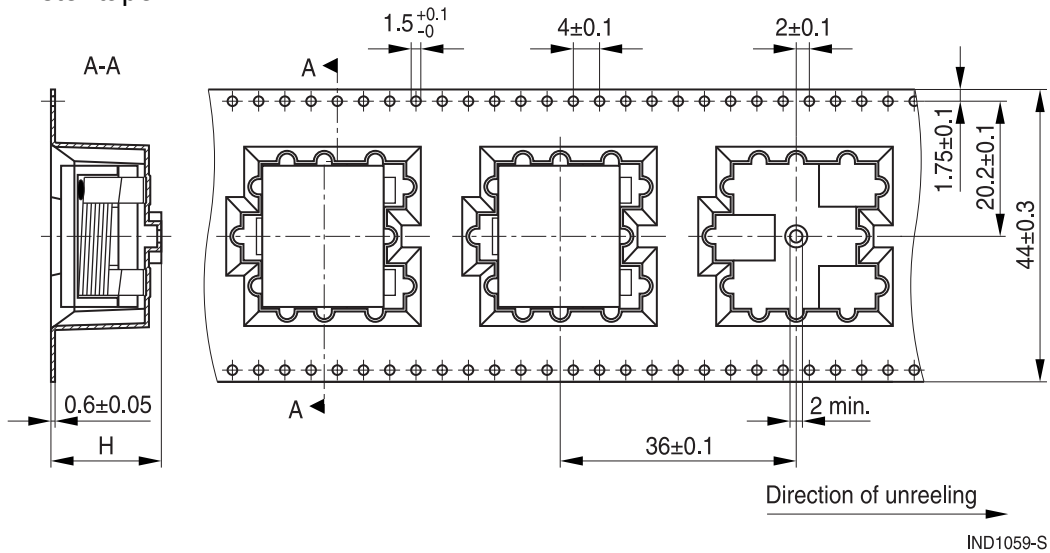

IND1059-S

Reel:

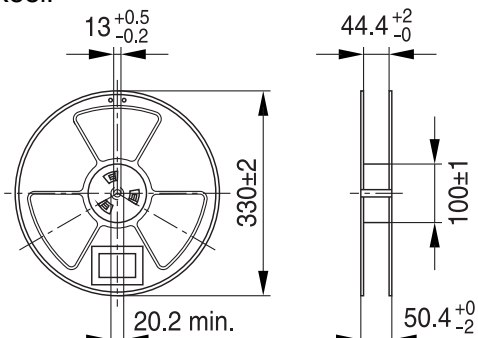

Dimensions in mm

Height (mm)		Packaging unit (pcs.)
Component (h)	Blister tape (H)	Per reel
9.8	10.8	150
10.8	12.5	130
12.2	13.9	115
13.2	14.9	110
14.2	15.9	100

SMT Power Inductors
ERU 20, helically wound
B82559*A020
Technical data and measuring conditions

Inductance L	Measured with Wayne-Kerr 3260/3265 at 0.1 V, +25 °C, 100 kHz
Inductance tolerance	±10 %
Saturation current I [L _{IDC}]	Current that will result in approx. 10-15 % drop in inductance values
Rated inductance L _{IDC}	The minimum allowable inductance at the saturation current I[L _{IDC}]
DC resistance R _{DC} (max)	Measured at +25 °C, toleranced resistances upon request
Self-resonant frequency	> 2 MHz
Solderability	+235 °C, 5 s Wetting of soldering area ≥ 90% (based on IEC 60068-2-58, solder bath method)
Resistance to soldering heat	To JEDEC J-STD 020D
Operating temperature	-40 °C ... +150 °C
Storage conditions (packaged)	-25 °C ... +40 °C, ≤ 75% RH

Characteristics and ordering codes

L	L	I _{sat}	R _{DC} (max)	R _{DC} (typ)	Height h (max.)	Approx. weight	Ordering code
μH	at I _{sat} μH	A	mΩ	mΩ	mm	g	
1.0	0.75	50.0	0.62	0.55	9.8	15.7	B82559A2102A020
1.5	1.10	50.0	0.9	0.78	10.8	17.6	B82559A3152A020
2.2	1.60	43.0	1.2	1.0	12.2	19.8	B82559A4222A020
3.3	2.50	34.0	1.5	1.28	13.2	22.5	B82559A5332A020
4.7	3.50	22.0	2.6	2.15	9.8	15.7	B82559A4472A020
6.8	5.10	19.0	2.9	2.68	9.8	16.3	B82559A5682A020
10.0	7.50	18.3	3.9	3.74	10.8	18.1	B82559A7103A020
15.0	11.2	15.3	4.9	4.65	12.2	19.7	B82559A9153A020
20.0	14.9	14.3	6.4	6.0	14.2	22.5	B82559A0203A020
29.0	21.5	11.0	7.0	6.65	14.2	23.9	B82559A0293A020
35.0	26.0	9.3	7.0	6.65	14.2	23.9	B82559A0353A020

Inductance L versus DC load current I_{DC}

The temperature rise T_R is measured at an ambient of +25 °C. A current is applied for 30 minutes and the temperature is measured when point equilibrium is reached via a thermal coupler placed on top of the device. No forced air cooling is applied.

The inductance vs. current curves are generated by measuring the inductors at +25 °C and +100 °C using a Wayne Kerr PM 3260A with the related bias units.

Ordering code: B82559A3152A020

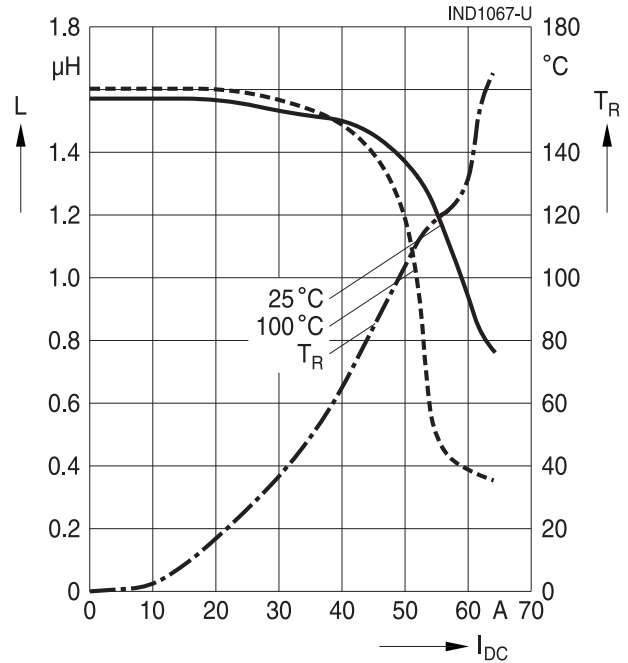

Ordering code: B82559A2102A020

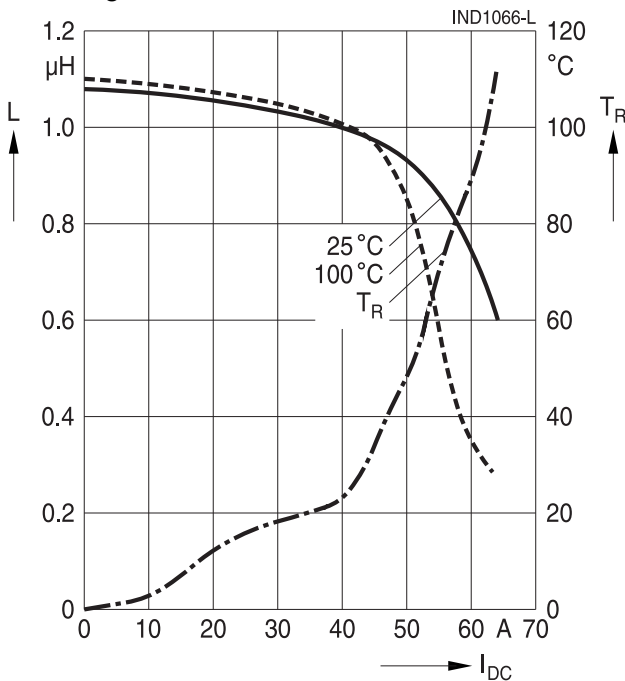

Ordering code: B82559A4222A020

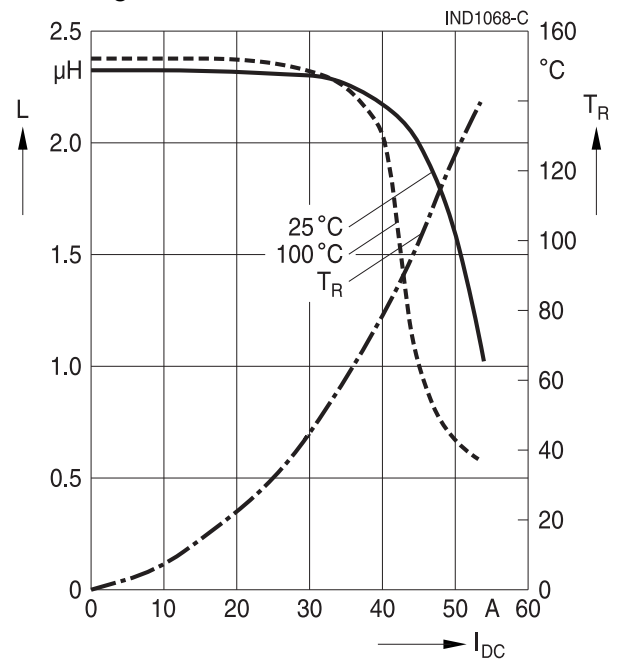

Ordering code: B82559A5332A020

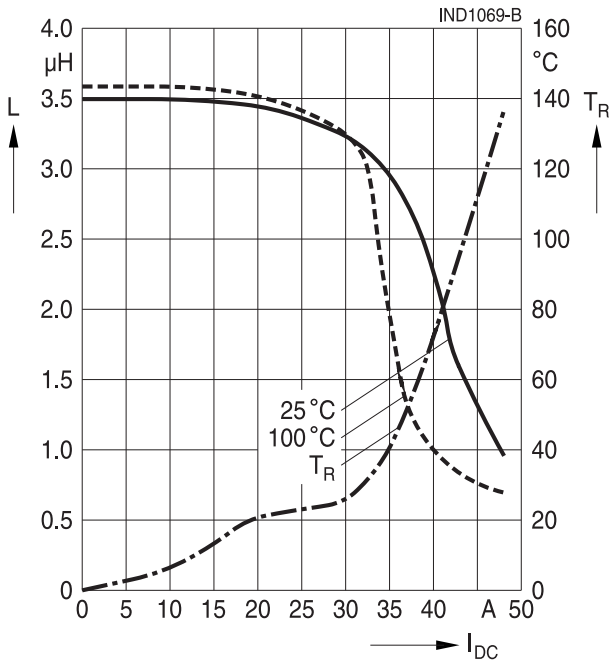

Ordering code: B82559A5682A020

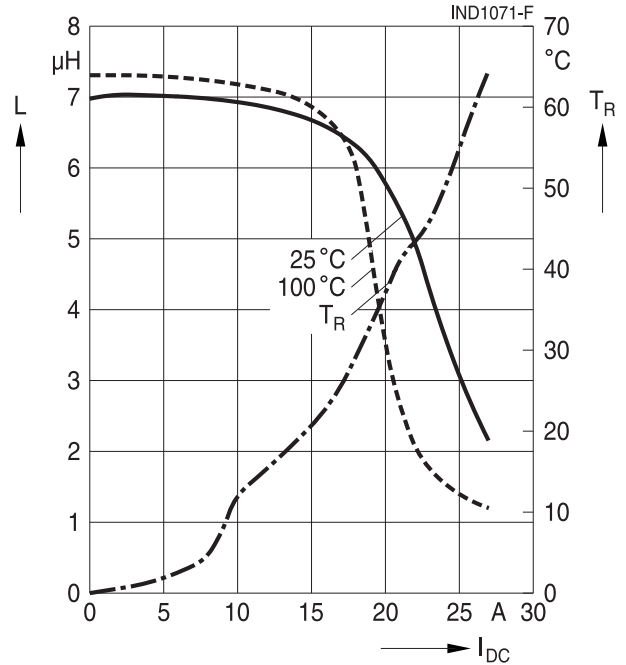

Ordering code: B82559A4472A020

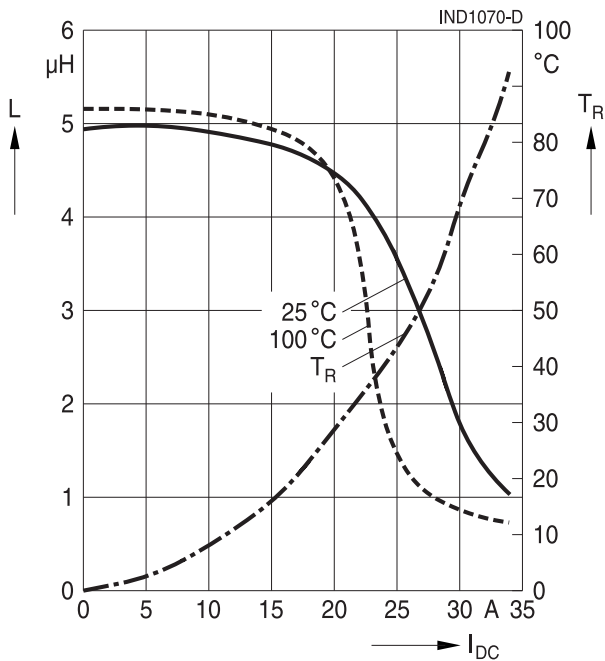

Ordering code: B82559A7103A020

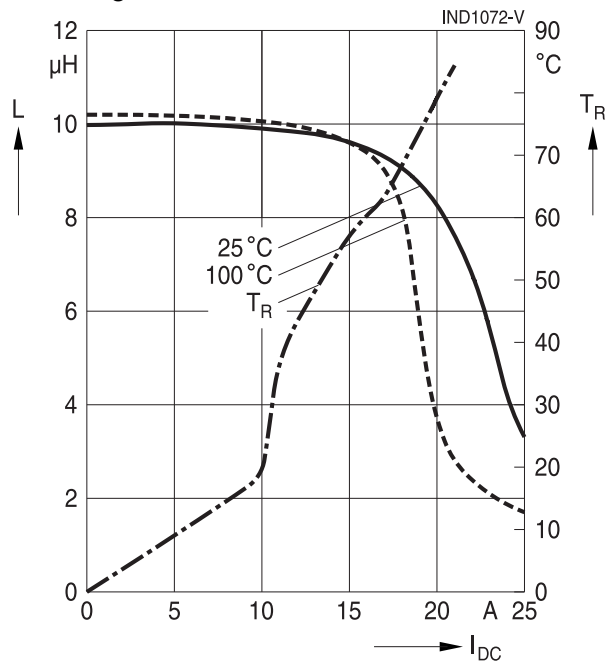

Ordering code: B82559A9153A020

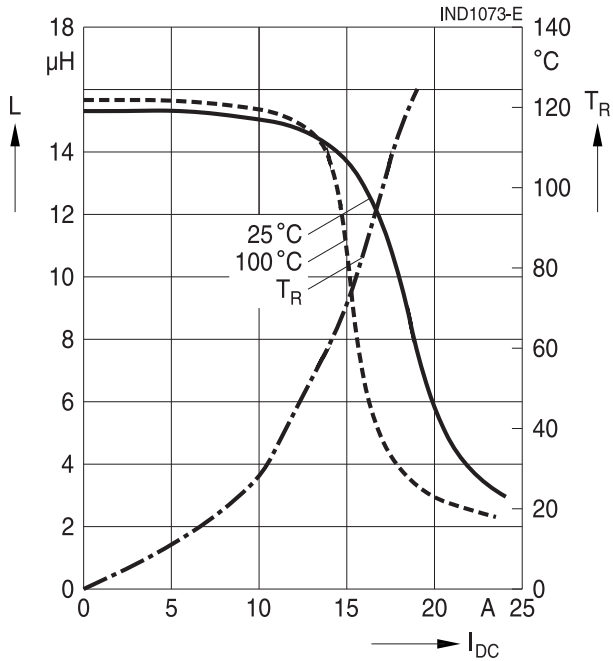

Ordering code: B82559A0293A020

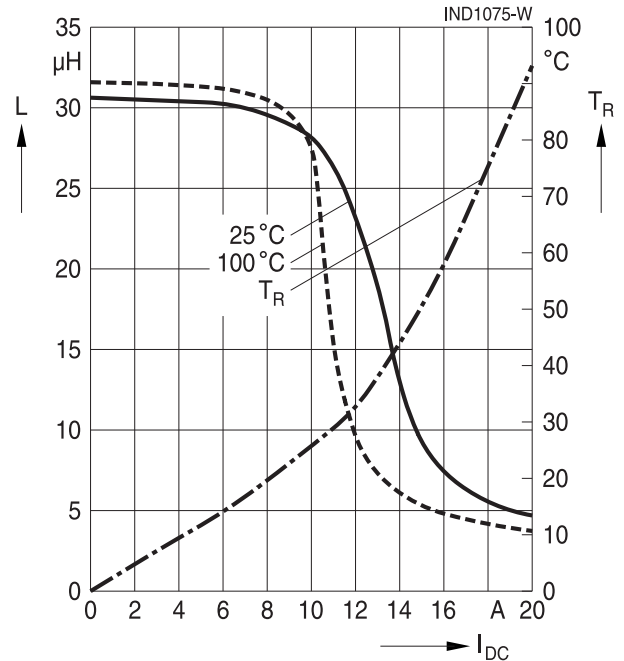

Ordering code: B82559A0203A020

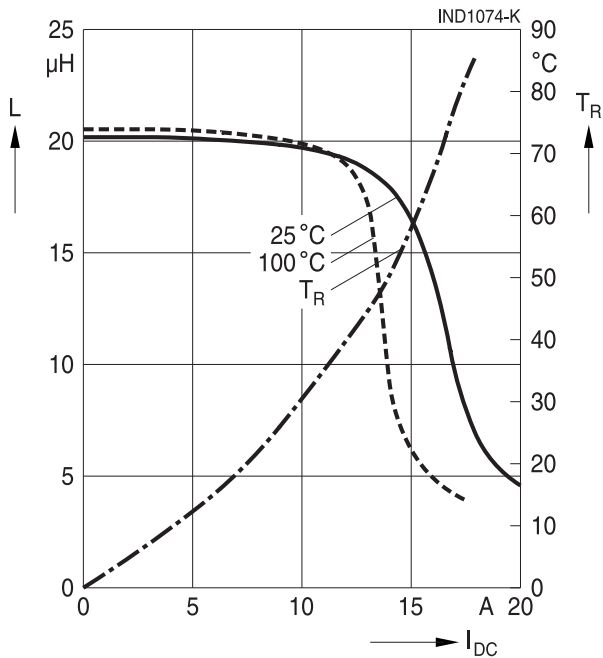

Ordering code: B82559A0353A020

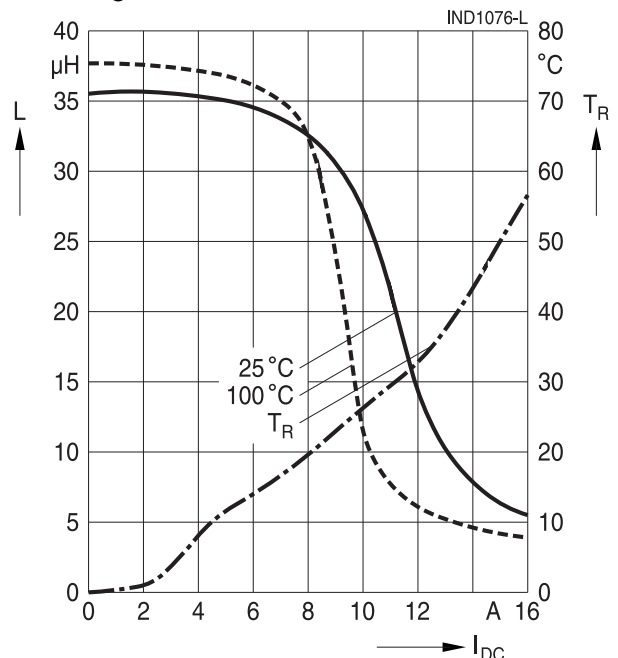

Cautions and warnings

- Please note the recommendations in our Inductors data book (latest edition) and in the data sheets.
 - Particular attention should be paid to the derating curves given there.
 - The soldering conditions should also be observed. Temperatures quoted in relation to wave soldering refer to the pin, not the housing.
- If the components are to be washed varnished it is necessary to check whether the washing varnish agent that is used has a negative effect on the wire insulation, any plastics that are used, or on glued joints. In particular, it is possible for washing varnish agent residues to have a negative effect in the long-term on wire insulation
Washing processes may damage the product due to the possible static or cyclic mechanical loads (e.g. ultrasonic cleaning). They may cause cracks to develop on the product and its parts, which might lead to reduced reliability or lifetime.
- The following points must be observed if the components are potted in customer applications:
 - Many potting materials shrink as they harden. They therefore exert a pressure on the plastic housing or core. This pressure can have a deleterious effect on electrical properties, and in extreme cases can damage the core or plastic housing mechanically.
 - It is necessary to check whether the potting material used attacks or destroys the wire insulation, plastics or glue.
 - The effect of the potting material can change the high-frequency behaviour of the components.
- Ferrites are sensitive to direct impact. This can cause the core material to flake, or lead to breakage of the core.
- Even for customer-specific products, conclusive validation of the component in the circuit can only be carried out by the customer.

Important notes

The following applies to all products named in this publication:

1. Some parts of this publication contain **statements about the suitability of our products for certain areas of application**. These statements are based on our knowledge of typical requirements that are often placed on our products in the areas of application concerned. We nevertheless expressly point out **that such statements cannot be regarded as binding statements about the suitability of our products for a particular customer application**. As a rule, EPCOS is either unfamiliar with individual customer applications or less familiar with them than the customers themselves. For these reasons, it is always ultimately incumbent on the customer to check and decide whether an EPCOS product with the properties described in the product specification is suitable for use in a particular customer application.
2. We also point out that **in individual cases, a malfunction of electronic components or failure before the end of their usual service life cannot be completely ruled out in the current state of the art, even if they are operated as specified**. In customer applications requiring a very high level of operational safety and especially in customer applications in which the malfunction or failure of an electronic component could endanger human life or health (e.g. in accident prevention or life-saving systems), it must therefore be ensured by means of suitable design of the customer application or other action taken by the customer (e.g. installation of protective circuitry or redundancy) that no injury or damage is sustained by third parties in the event of malfunction or failure of an electronic component.
3. **The warnings, cautions and product-specific notes must be observed.**
4. In order to satisfy certain technical requirements, **some of the products described in this publication may contain substances subject to restrictions in certain jurisdictions (e.g. because they are classed as hazardous)**. Useful information on this will be found in our Material Data Sheets on the Internet (www.epcos.com/material). Should you have any more detailed questions, please contact our sales offices.
5. We constantly strive to improve our products. Consequently, **the products described in this publication may change from time to time**. The same is true of the corresponding product specifications. Please check therefore to what extent product descriptions and specifications contained in this publication are still applicable before or when you place an order. We also **reserve the right to discontinue production and delivery of products**. Consequently, we cannot guarantee that all products named in this publication will always be available. The aforementioned does not apply in the case of individual agreements deviating from the foregoing for customer-specific products.
6. Unless otherwise agreed in individual contracts, **all orders are subject to the current version of the "General Terms of Delivery for Products and Services in the Electrical Industry" published by the German Electrical and Electronics Industry Association (ZVEI)**.
7. The trade names EPCOS, BAOKE, Alu-X, CeraDiode, CeraLink, CSMP, CSSP, CTVS, DeltaCap, DigiSiMic, DSSP, FilterCap, FormFit, MiniBlue, MiniCell, MKD, MKK, MLSC, MotorCap, PCC, PhaseCap, PhaseCube, PhaseMod, PhiCap, SIFERRIT, SIFI, SIKOREL, SilverCap, SIMDAD, SiMic, SIMID, SineFormer, SIOV, SIP5D, SIP5K, ThermoFuse, WindCap are **trademarks registered or pending** in Europe and in other countries. Further information will be found on the Internet at www.epcos.com/trademarks.