



### Marking on IR Receiver Modules

#### CAST

PART NUMBER	MARKING CODE
TSOP11xxx	TSOP11xxx
TSMP1138	TSMP1138
TSOP31xxx	TSOP31xxx
TSOP31xxxR	TSOP31xxxR
TSOP91xxx	TSOP91xxx

Code for lot tracking

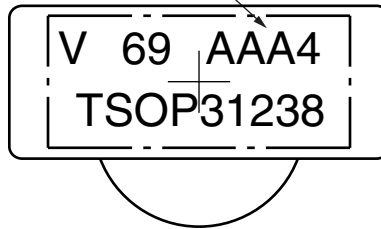

#### MINICAST

PART NUMBER	MARKING CODE
TSOP18xxx	V18xxx
TSOP38xxx	V38xxx
TSOP38xxxV	V38xxxV
TSOP58xxx	V58xxx
TSOP58xxxA	V58xxxA
TSOP98xxx	V98xxx
TSSP58xxx	S58xxx
TSSP58xxxXB	V58xxxB
TSMP58xxx	M58xxx

Code for lot tracking

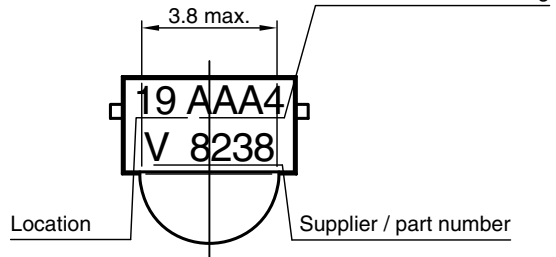

xxxxxx R for all types TSxPxxxxR



**TVCAST**

PART NUMBER	MARKING CODE
TSOP19xxx	V19xxx
TSOP39xxx	V39xxx
TSOP59xxx	V59xxx
TSOP99xxx	V99xxx

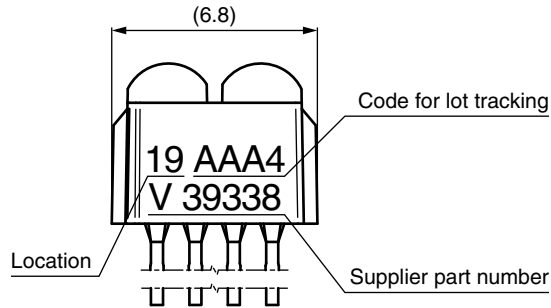

**MOLD**

PART NUMBER	MARKING CODE
TSOP12xxx	V12xxx
TSOP12xxxF	V12xxxF
TSOP14xxx	V14xxx
TSOP14xxxF	V14xxxF
TSOP2xxx	V2xxx
TSOP2xxxF	V2xxxF
TSOP2xxxN	V2xxxN
TSOP32xxx	V32xxx
TSOP32xxxF	V32xxxF
TSOP32xxxN	V32xxxN
TSOP32xxxV	V32xxxV
TSOP32xxxVF	V32xxxVF
TSOP34xxx	V34xxx
TSOP34xxxA	V34xxxA
TSOP34xxxF	V34xxxF
TSOP34xxxN	V34xxxN
TSOP34xxxV	V34xxxV
TSOP34xxxFA	V34xxxFA
TSOP34xxxFABL	V34xxxFA
TSOP4xxx	V4xxx
TSOP4xxxF	V4xxxF
TSOP4xxxN	V4xxxN
TSOP4xxxL	V4xxxL
TSOP4xxxFA	V4xxxFA
TSOP92xxx	V92xxx
TSOP92xxxF	V92xxxF
TSOP94xxx	V94xxx
TSOP94xxxF	V94xxxF
TSOP94138	V94138
TSDP34xxx	VD34xxx
TSSP4xxx	S4xxx
TSMP4xxx	M4xxx

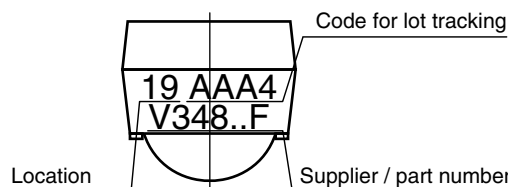

### MINIMOLD

PART NUMBER	MARKING CODE
TSOP19xxx	V19xxx
TSOP19xxxF	V19xxxF
TSOP33xxx	V33xxx
TSOP33xxx...F	V33xxxF
TSOP53xxx	V53xxx
TSOP53xxx...F	V53xxxF
TSOP99xxx	V99xxx
TSOP99xxxF	V99xxxF

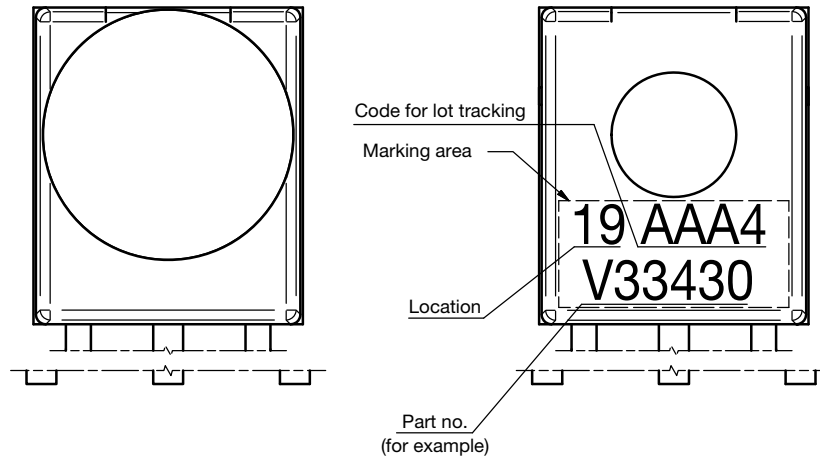

### PANHEAD

PART NUMBER	MARKING CODE
TSOP16xxx	16xxx
TSOP16xxxF	16xxxF
TSOP36xyy	38x*
TSOP36xyyF	36x*F
TSOP36xyyN	36x*N
TSOP36xyyV	36x*V
TSOP36xyyVF	36x*FV
TSOP6xyy	6x*
TSOP6xyyAP	6x*AP
TSOP6xyyF	6x*F
TSOP6xyyN	6x*N
TSOP96xxx	96xxx
TSOP96xxxF	96xxxF
VEMD8130	8130

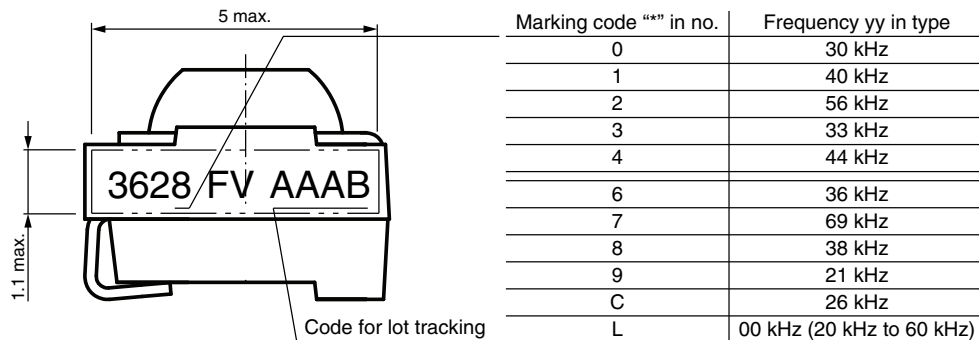



**HEIMDALL** (with and without lens)

PART NUMBER	MARKING CODE
TSOP15xyy	15x*
TSOP15xyyW	15x*W
TSOP15xyyF	15x*F
TSOP15xyyFW	15x*FW
TSOP75xyy	75x*
TSOP75xyyW	75x*
TSOP75xyyF	5xF*
TSOP75xyyFW	5xF*
TSOP75xyyFV	5xZ*
TSOP75xyyFWW	5xZ*
TSOP75xyyV	5xV*
TSOP75xyyS	5xS*
TSOP75xyyRF	5xR*
TSOP75xyyWRF	5xR*
TSOP77xyy	77x*
TSOP77xyyW	77x*
TSOP77xyyAP	AP*
TSOP77xyyF	7xF*
TSOP77xyyFW	7xF*
TSOP75xyyN	5xN*
TSOP95xyy	95x*
TSOP95xyyW	95x*W
TSOP95xyyF	95x*F
TSOP95xyyFW	95x*FW
TSMP77xyy	7M*
TSSP77xyy	7S*

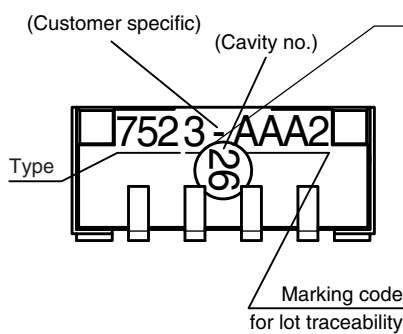

Marking code "AA" in no.	Frequency yy in type
0	30 kHz
3	33 kHz
6	36 kHz
8	38 kHz
1	40 kHz
2	56 kHz
5	25 kHz
4	44 kHz
9	21 kHz
7	69 kHz
C	26 kHz
L	00 kHz (20 kHz to 60 kHz)
A	85 kHz



## BELOBOG (with and without shield)

PART NUMBER	MARKING CODE
TSOP17yy	17x*
TSOP17yyH	17xH*
TSOP37xyy	3x*
TSOP37xyyH	3xH*
TSOP37xyyE	3x*E
TSOP57xyy	5x*
TSOP57xyyH	5xH*
TSOP97xyy	97x*
TSOP97xyyH	97xH*
TSSP57xyy	Sx*
TSSP57xyyE	Sx*E
TSOP57xyyE	5*E
TSSP57xyyH	SxH*

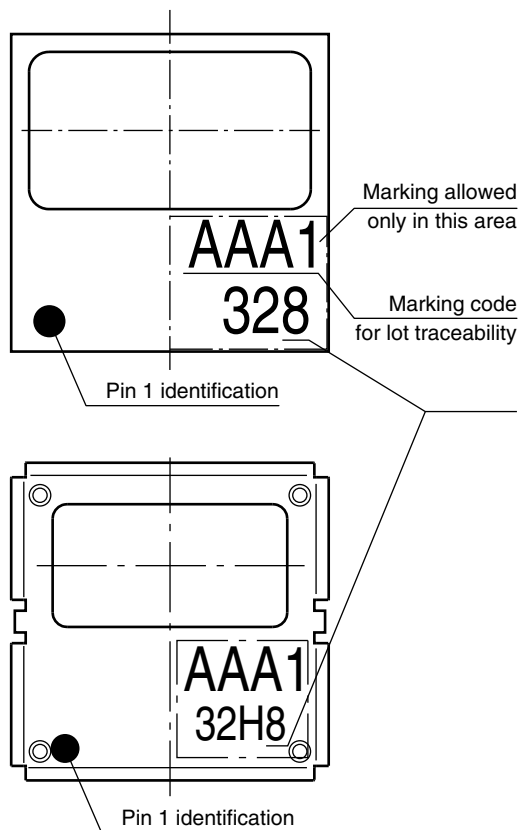

Marking code “**” in no.	Frequency yy in type
0	30 kHz
3	33 kHz
6	36 kHz
8	38 kHz
1	40 kHz
2	56 kHz
5	25 kHz
4	44 kHz
9	21 kHz
7	69 kHz



## 2 mm x 2 mm DFN PACKAGE

PART NUMBER	MARKING CODE
VSOP38xyy	33yy
VSOP58xyy	53yy

