

**KEMET Part Number: PHBC13-1R2A0081V**  
(UALP131R2A0081)

KEMET, PHBC, AC Line Filters, Normal Mode, 81 uH, 20%

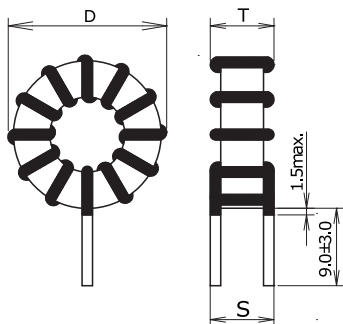

#### Dimensions

<b>D</b>	30mm MAX
<b>T</b>	15.7mm MAX
<b>LL</b>	9mm +/-3mm
<b>S</b>	11mm NOM

#### Packaging Specifications

<b>Packaging:</b>	Tray
<b>Packaging Quantity:</b>	150
<b>Weight:</b>	30 g

#### General Information

<b>Series:</b>	PHBC
<b>Style:</b>	Through-Hole
<b>Features:</b>	Switching Power Supply Outlet, DC-DC Converter, Phase Compensation, Noise Solution
<b>RoHS:</b>	Yes
<b>Miscellaneous:</b>	30 (K) Temperature Rise Max.

#### Specifications

<b>Inductance:</b>	81 uH (0.1 MHz)
<b>Inductance Tolerance:</b>	20%
<b>Current:</b>	6 A
<b>Temperature Range:</b>	-40/+125°C
<b>DC Resistance:</b>	24.7 mOhms