

SAC-5P- 3,0-PUR/M12FR

Order No.: 1669864



Sensor/Actuator cable, 5-position, PUR halogen-free, Black-gray RAL 7021, Free cable end, on Socket angled M12, A-coded, Cable length: 3 m

Commercial data

EAN	 4 017918 134761
Pack	1
Customs tariff	85444290
Gross weight in pieces	115.00 g
Country of Origin	IN
Catalog page information	Page 137 (PC-2011)

Product notes

WEEE/RoHS-compliant since:
01/08/2005



Please note that the data given here has been taken from the online catalog. For comprehensive information and data, please refer to the user documentation at <http://www.download.phoenixcontact.com>. The General Terms and Conditions of Use apply to Internet downloads.

Technical data**General data**

Rated current at 40°C	4 A
Rated voltage	60 V
Number of positions	5
Volume resistance	≤ 5 mΩ
Insulation resistance	≥ 100 MΩ

Length of cable	3 m
Stripping length of the free conductor end	50 mm
Ambient temperature (operation)	-25 °C ... 90 °C (Plug / socket)

General characteristics

Standards/regulations	M12 plug-in connector IEC 61076-2-101
Coding	A - standard
Surge voltage category	II
Pollution degree	3
Degree of protection	IP65/IP68/IP69K
Insertion/withdrawal cycles	≥ 100
Torque	0.4 Nm (M12 plug-in connector)
Contact material	CuSn
Contact surface material	Ni/Au
Contact carrier material	TPU GF
Material of grip body	TPU, hardly inflammable, self-extinguishing
Material, knurls	Zinc die-cast, nickel-plated
Sealing material	NBR
Status display	No

Conductor data

Cable type	PUR halogen-free black
Cable type (abbreviation)	PUR
UL AWM style	20549
Conductor cross section	5x 0.34 mm ² (signal line)
AWG signal line	22
Conductor structure signal line	42x 0.10 mm
Core diameter including insulation	1.27 mm ±0.02 mm (signal line)
Thickness, insulation	approx. 0.7 mm
Wire colors	brown, white, blue, black, green-yellow
External sheath, color	Black-gray RAL 7021
External cable diameter D	5 mm ±0.15 mm
Smallest bending radius, fixed installation	25 mm
Smallest bending radius, movable installation	50 mm
Number of bending cycles	4000000
Bending radius	50 mm

Traversing path	10 m
Traversing rate	3 m/s
Acceleration	10 m/s ²
Cable weight	35 kg/km
Outer sheath, material	PUR
Conductor material	Bare Cu litz wires
Insulation resistance	≥ 16 GΩ*km (at 20 °C)
Conductor resistance	max. 58 Ω/km (at 20 °C)
Nominal voltage, conductor	300 V
Test voltage, conductor	3000 V
Special properties	Flexible cable conduit capable
	Silicone-free
	Free of substances which would hinder coating with paint or varnish
	Flexible
Flame resistance	in accordance with DIN UL-Style 20549
Halogen-free	in accordance with DIN VDE 0472 part 815
Resistance to oil	in accordance with DIN EN 60811-2-1
Other resistance	Highly resistant to acids, alkaline solutions and solvents
	hydrolysis and microbe resistant
	Resistant to salt water
	partly UV-resistant in accordance with DIN EN ISO 4892-2-A
Ambient temperature (operation)	-40 °C ... 80 °C (cable, fixed installation)
	-25 °C ... 80 °C (cable, flexible installation)

Certificates



Certification

cULus Listed, GOST

Certifications applied for:

Certification Ex:

Accessories		
Item	Designation	Description
Fuse		
1558991	SAC-M12-EXCLIP-F	Fuse clip for the socket side of various M12 sensor/actuator connectors prevents plug-in connections being interrupted without using a tool
Marking		
1051993	B-STIFT	Marker pen, for manual labeling of unprinted Zack strips, smear-proof and waterproof, line thickness 0.5 mm
1013944	PABA RD/15	Insert label, Strip, red, Unlabeled, Can be labeled with: Plotter, Mounting type: Thread on, Cable diameter: 0.6-50 mm, Lettering field: 15 x 4 mm
1013151	PABA WH/15	Insert label, Strip, white, Unlabeled, Can be labeled with: Plotter, Mounting type: Thread on, Cable diameter: 0.6-50 mm, Lettering field: 15 x 4 mm
1013698	PABA YE/15	Insert label, Strip, yellow, Unlabeled, Can be labeled with: Plotter, Mounting type: Thread on, Cable diameter: 0.6-50 mm, Lettering field: 15 x 4 mm
1013850	PATG 2/23	Conductor marker carrier, transparent, Unlabeled, Mounting type: Slide on, Cable diameter: 2-4 mm, Lettering field: 4 x 23 mm
1013863	PATG 3/23	Conductor marker carrier, transparent, Unlabeled, Mounting type: Slide on, Cable diameter: 4-7 mm, Lettering field: 4 x 23 mm
0808011	PATG 4/23	Conductor marker carrier, transparent, Unlabeled, Mounting type: Slide on, Cable diameter: 6-10 mm, Lettering field: 4 x 23 mm
Protection and sealing elements		
1430899	PROT-M12 MS-PA-CHAIN	M12 sealing cap with fixing band, for sensor cables, for free M12 sockets
Tools		
1212207	CUTFOX-S VDE	Diagonal cutter for copper and aluminum conductors, VDE-tested
1208432	SAC BIT M12-D15	Nut for assembling sensor/actuator cables with M12 connector and for M12 connectors with QUICKON fast connection technology, for 4 mm hexagonal drive
1208429	TSD 04 SAC	Torque screwdriver, with preset torque of 0.4 Nm and 4 mm hexagonal drive for M12 connectors
1212224	TSD-M 1,2NM	Torque screw driver, accuracy as per EN ISO 6789 standard, adjustable from 0.3 - 1.2 Nm
1212600	TSD-M SAC-BIT ADAPTER	Adapter bit for TSD-M...torque tools, E6.3-1/4" drive with 4 mm hexagon to accommodate SAC bits

1212150	WIREFOX 10	Stripping tool, for cables and conductors from 0.02 - 10 mm ² , self-adjusting, stripping length of up to 18 mm, cutting capacity of up to 10 mm ² stranded/1.5 mm ² solid, replaceable stripping blade
1212623	WIREFOX SAC	Stripping pliers, for halogen-free sensor/actuator cables (SAC cables), with PUR and PVC insulation, from Ø of 4.4 to 7 mm, any stripping length

Drawings

Dimensioned drawing

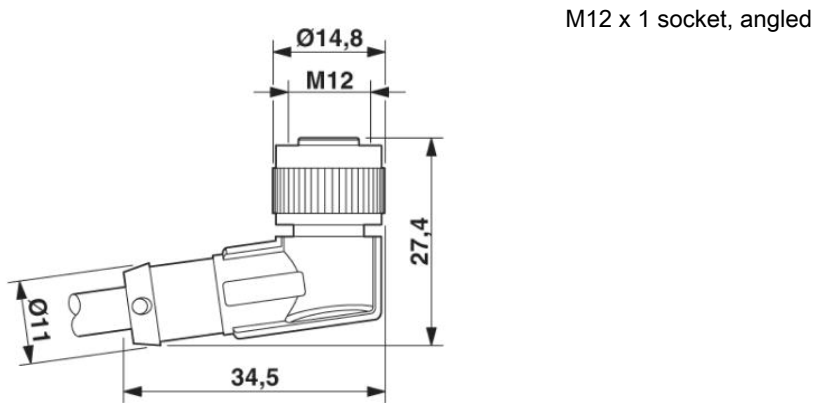

Circuit diagram

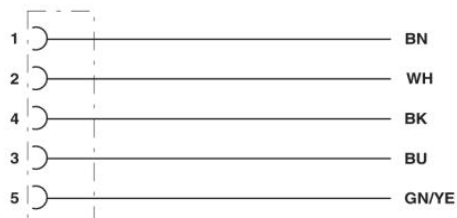

Contact assignment of the M12 sockets

Schematic diagram

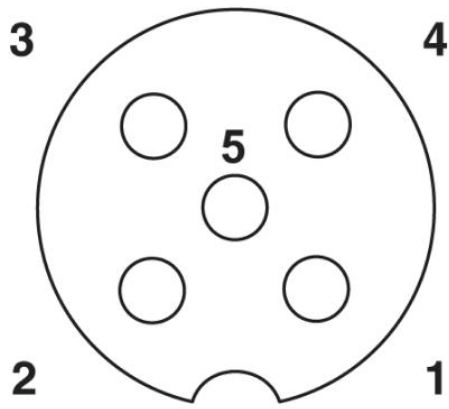

Pin assignment M12 socket, 5-pos., A-coded, socket side view

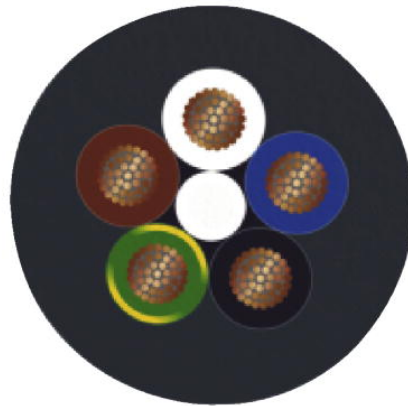

PUR halogen-free black [PUR]

Address

PHOENIX CONTACT Ltd
Halesfield 13
Telford / Shropshire / TF7 4PG,England
Phone 01952 681 700
Fax 01952 681 799
<http://www.phoenixcontact.co.uk>



Phoenix Contact Ltd.
Technical modifications reserved;