



Instruction Manual

for

Soldering / SMD Rework Station

LF-1680

For Lead-free soldering application and rework on professional SMD electronics.

INTRODUCTION

Thank you for purchasing Xytronic's soldering and SMD rework station. This appliance is specially designed for both lead free soldering and SMD chips, SOT, Flat pack ICs' etc. reworking without alternating the wands. **Please carefully** read the instruction manual prior to operate to maximize the advantages of using your new rework station.

 **WARNING:** This appliance is not intended for use by children or other persons without assistance or supervision if their physical, sensory or mental capabilities prevent them from using it safely. Children should be supervised to ensure that they do not play with the appliance. Failure to observe the safety regulation will result in a risk to life and limb. The manufacturer shall not be liable for damage resulting from misuse of the unit or unauthorized alterations.

 **CAUTION:**

- ◆ Always place the soldering iron or tweezers in its original holder when not being used.
- ◆ Keep the soldering/tweezers tip and heating element away from the body, clothes and flammable material when in operation.
- ◆ The soldering/tweezers tip and the heating element are still remaining hot after being switched off. Ensure that you do not touch the soldering tip and the heating element.
- ◆ For your health, do not inhale solder fumes.
- ◆ You must not undertake work on live parts. Only the technician is permitted to undertake repairs. Use the original replacement part only.

KEY FEATURES

- ◆ **HEATER/SENSOR FAILED DETECTION:** If sensor circuit failed that the display read "S--E" and cut off the heater power. If heater circuit failed the display read "H--E" and cut off the heater power.
- ◆ **TEMPERATURE "LOCK-OUT" FEATURE:** The temperature can be locked by "password" code that is convenient for production line management.
- ◆ **ISOLATED HOLDER WITH TIP CLEANER:** Made of low abrasive brass shavings instead of conventional sponges to meet RoHS requirement cleans better and no water is necessary.
- ◆ **LOW VOLTAGE OUTPUT WITH SAFETY OPERATION:** The power unit is isolated from the A.C. line by a transformer and allows 32Vac to drive the heating

element. Both of the Solder wand and tweezers wand run from 32 Volts for safety and with 80W power ceramic heater for a super-fast heat-up and quick temperature recovery. Both of the solder wand and tweezers wand are attached with heat resistant, non-burning, flexible 5-wire cord.

- ◆ **CONVENIENT FUNCTION SWITCH:** Switch the function quickly that you want to select.
- ◆ **ESD SAFE AND SPIKE FREE CIRCUITRY:** The “Zero Voltage” electronic switching design also protects voltage and current sensitive components (CMOS devices, etc.) against damaging current and transient voltage spikes commonly produced by less efficient, mechanically switched stations.
- ◆ **DETACHABLE AC POWER CORD WITH PLUG:** Engineered AC outlet for alternating AC power cord with plug and connector specially designed for individual CE countries requirements.
- ◆ **EARTH JACK:** With a grounding connector, there is the possibility for a grounding of the wire strap if required.

PRODUCT DESCRIPTION

LF-1680 electronically temperature controlled rework station with specially intelligent chip microcomputer control designs was developed to meet the present and future Lead-free soldering needs of the electronic production industry and suitable for work on professional SMD electronics. An ergonomic handle with shorter distance between heating element and tip gets very fast heat up time and quick heat compensation. A high-quality sensor and heat transfer technology ensure precise temperature regulation is essential for making consistent, reliable soldered connections. The aluminum housing has the advantages of strong structure, good heat sink and effectively resistant of electro-magnetic interference. It provides all the benefits of temperature regulation and connects via a highly flexible burn-resistant lead, and can be easily adjusted in temperature.

The LF-1680 incorporates electronic circuitry which enables the user to alter tip temperature from 200 to 480°C (392-896°F) for soldering application without changing tips or heating elements. As for tweezers the temperature might be lower 30-50°C say to 430-450°C (806-842°F) due to the different tweezers tip. Also, with digital display readout and pressing keys on the front panel get clear vision and comfortable setting. The temperature is maintained within +/-3°C (+/- 6°F) of its operating temperature by a thermocouple sensor placed in the head of the heating element, allowing the tip to rest against the sensor. The 80W power results in both a

rapid heat-up and super fast recovery.

The revolutionary “Zero Voltage” electronic switching design also protects voltage and current sensitive components (CMOS devices. etc.) against damaging current and transient voltage spikes commonly produced by less efficient, mechanically switched stations. The power unit is isolated from the A.C. line by a transformer and allows only 32Vac to drive the heating element. The temperature “Lock-out” feature by “password” is convenient for production management. The many features of the product make it the ideal tool for service and repair technicians as well as production line soldering operations. This unit is developed to meet the present and future lead-free soldering needs of the electronic production industry and is ideal for use at any AC outlet.

BRIEF INTRODUCTION OF PANEL FUNCTIONS:

Front panel

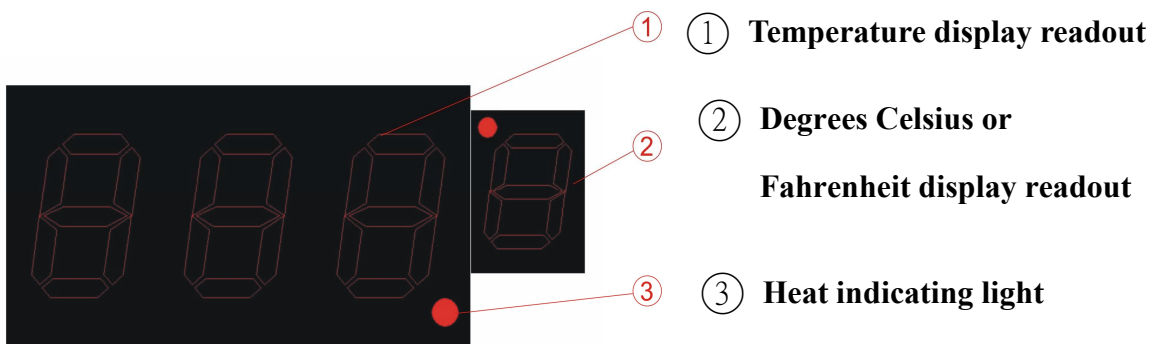

- ① **Temperature display readout**
- ② **Degrees Celsius or Fahrenheit display readout**
- ③ **Heat indicating light**



- ④ **Main power switch**
- ⑤ **Solder wand socket**
- ⑥ **Function switch**
- ⑦ **Tweezers socket**
- ⑧ **“▲”: Up key**
- ⑨ **“▼”: Down key**
- ⑩ **“SET”: Function key**

Rear side

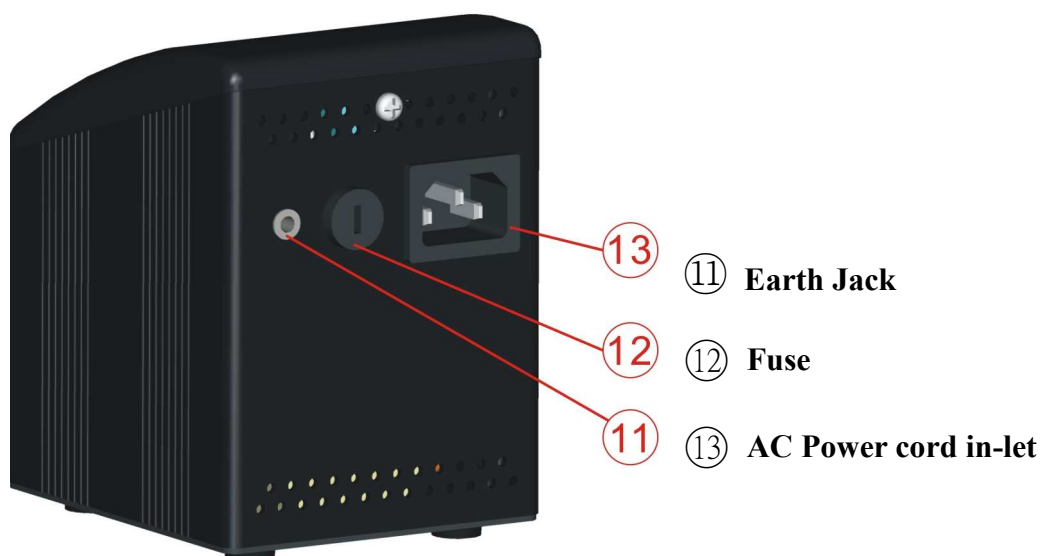

SPECIFICATIONS:

| | | |
|------------------------------|-----------------------------------|-----------------|
| Model | LF-1680 | |
| Input | 220-240Vac 50Hz | 100-120Vac 60Hz |
| Output | 32Vac/80W | |
| Fuse (Slow type) | T1A | T2A |
| Temperature Range | 200°C -480°C (392°F -896°F) | |
| Temperature Correction Range | +99°C ~-99°C /+178°F ~-178°F | |
| Default Set | 200°C /392°F | |
| | Temperature correction value "00" | |
| Figure Dimension | 105 x 90 x 126mm (W x H x D) | |
| Weight (Unit only) | 1.5kg | |

WORKING TEMPERATURE

To meet RoHS requirements, the 60/40 solder alloys are not allowed in the production process. The lead free solder alloys require a working temperature of 30°C (54°F) higher than previous generation electrical soldering. The working temperature of solder is detailed below and can vary from manufacture to manufacture.

| | |
|---------------------------|-----------------------|
| Melting point | 220°C (428°F) |
| Normal operation | 300-360°C (572-680°F) |
| Production line operation | 360-410°C (680-770°F) |

When the iron's working temperature is set within the parameters suitable for the type

of solder being used, a good joint is assured. Too low of a temperature will slow the rate of solder flow while a high temperature setting might burn the flux in the solder and emit a heavy, white smoke resulting in a dry joint or permanent damage to the printed circuit board (P.C.B.) and may also shorten the tip life.

IMPORTANT: The temperature above 410°C (770°F) is not recommended for normal soldering functions, but can be used for short periods of time when high temperatures are required. **Please note** that the lead free solder alloys require a higher soldering temperature which shortens tip life.

OPERATING INSTRUCTIONS

- Ensure that the working voltage matches your power supply before beginning use.
- Check carefully for any damage during transportation.
- The unit contains:
 1. Solder wand
 2. Tweezers wand
 3. Iron holder with brass tip cleaner.
 4. Tweezers holder with brass tip cleaner
 5. AC power cord with plug.

OPERATING PROCEDURES:

SOLDER IRON OPERATING PROCEDURES

1. Ensure that the base unit power switch is in the “OFF” position.
2. Plug in Solder wand and connect AC power cord to mains “In-let”
3. Flip the “TWZ/SIA” function switch on to the “SIA” position.
4. Turn “Mains power switch” to “ON” position.
5. Press the “▲” key up until the temperature to 250°C (482°F) (If set to degrees Centigrade, the temperature display window of the upper right corner shows °C, if set to degrees Fahrenheit, the temperature display window of the upper right corner shows °F). Then tin the surface of the tip by applying a new covering of solder after being warmed to protect tip and extend its life.
6. When the temperature reaches to the desired temperature that the heating indicator light will be flashed on and off to maintain the set temperature. The unit now is ready for use.

Fig. 1 Soldering iron assembly 108ESD



TWEEZERS OPERATING PROCEDURES

1. Ensure that the base unit power switch is in the “OFF” position.
2. Plug in Tweezers wand and connect AC power cord to mains “In-let”
3. Flip the “TWZ/SIA” function switch on to the “TWZ” position.
4. Turn “Mains power switch” to “ON” position.
5. Press the key “▲” and choose the temperature you want to set.
6. When the temperature reaches to the desired temperature that the heating indicator light will be flashed on and off to maintain the set temperature. The unit now is ready for use.
7. Gently pick up and remove components while ensuring that a vertical pick up and pull out motion is maintained.

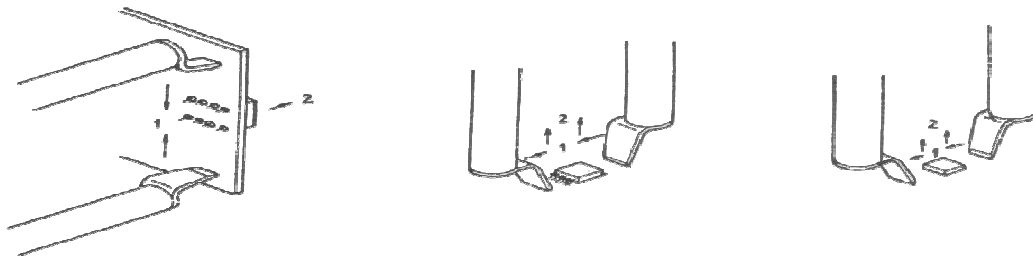

Please note :

1. The tweezers temperature will be lower about 50°C than the soldering iron temperature at the same temperature setting.
2. Use only the approximately designed tips for the job to avoid unnecessary component damage.

Fig. 2 Drawing of Tweezers & spares SMD tips for TWZ80

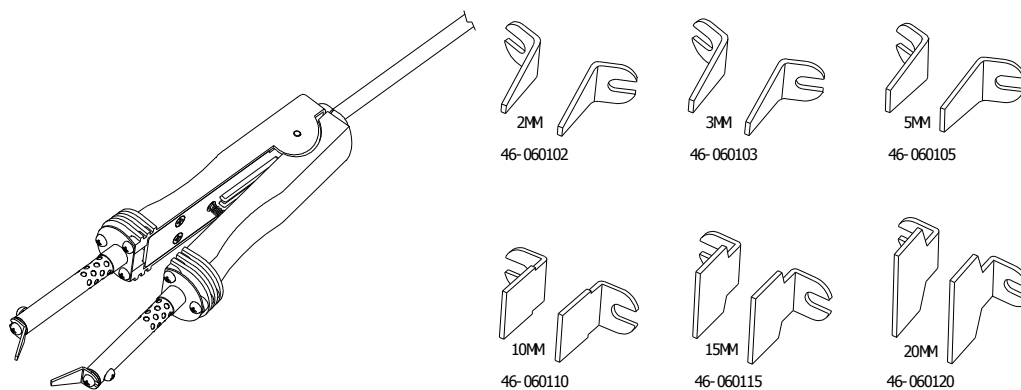

⚠ CAUTIONS:

REMEMBER, THE TIP IS HOT!

- The tip and barrel of the solder wand will cause serious burns if they are allowed to contact skin. Always return the solder wand to the safety holder after each use.

DO NOT WORK ON LIVE CIRCUITS

- Before working on any mains powered equipment, make sure that it is turned off, and the mains plug is removed from the power point.

DO NOT USE IF DAMAGED

- If the power lead becomes damaged or the rework station becomes faulty, discontinue use immediately. To comply with safety standards, the power lead must only be replaced by authorized technicians as special purpose tools are required.

Caution: Soldering irons or SMD Tweezers operate at high temperatures and can easily burn people or objects. Do not touch the tip and heater at any time and keep it a safe distance from flammable materials while the unit is on or while it's cooling. Please allow a sufficient time for it to cool before changing tips or servicing the unit!

TEMPERATURE SETTING: (No password set)

1. Increase temperature: By pressing “▲” key one time, the digital will be increase “1” numeral. If pressing “▲” key over 2 seconds then the digital numerals will be forwarded counting continuously till the temperature up to what you desire to set.
2. Decrease temperature: By pressing“▼” key, the same procedure as above.

PARAMETER SETTING:

1. Press “SET” key and hold for at least 4 seconds until display shown “— — —” sign then release the “SET” key. The sign “— — —” starts to flash and reminding the user to input the mode lock password “010” (fixed). If the user inputs the same number as “010”, the unit will enter the modes selection procedure, otherwise, the unit will be back from the current mode automatically.
2. After the unit enters the Modes selection, the LED will display “F-0”and flash. Press “▲”or “▼” key to select modes. If the user doesn't press “▲” or “▼” key within 15 seconds or press “SET” key one time, then the unit will be immediately back from the Parameter Set status.

For example: F-0 → F-1 → F-2 → F-3

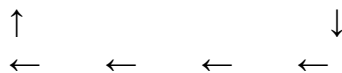

3. Password Setting:

When the LED displays “F-1” and flashes, press “SET” key one time and the unit enters the Password Set status. At this moment, the LED displays the pre-set value. Press “▲” or “▼” key to change password set value. If the user sets “000” that means the unit will be under the status of no password. If the user sets “100” then means the unit will be under the password status. Press “SET” key once to finish password setting and the unit will backup mode, the user can continue set other modes or back from the setting mode.

4. Temperature Correction Setting

Press “SET” key once when the LED displays “F-2” and flashes that the unit enters the Temperature Correction Mode. At this moment, the LED displays preset correction value.

A: Operation of Centigrade temperature correction ($+99^{\circ}\text{C} \sim -99^{\circ}\text{C}$)

Press “▲” or “▼” key to change the temperature correction value. The first digit “—” means minus (actual temperature is down), “No display” means plus (actual temperature is up).

B: Operation of Fahrenheit temperature correction value ($+178^{\circ}\text{F} \sim -178^{\circ}\text{F}$)

Press “▲” or “▼” key to change the temperature correction value. When the numbers is sparkling on LED displays, it means minus value (actual temperature is down), when the numbers stop sparkling, it means plus value (actual temperature is up). Press “SET” key once to finish the temperature correction and the unit automatically backup mode. The user may continue set other modes or back from the current setting mode.

Example for temperature correction: The current set temperature value is 200°C , however, the actual temperature is only 190°C . So it needs to correct by $+10^{\circ}\text{C}$.

Correction method: if the current correction value is 00 or -00; then change it to 10. If the current correction value is -20, then change it to -10. If the current correction value is 20, then change it to 30.

5. Fahrenheit and Centigrade (Celsius) temperature selection

When temperature display window shows "F-3" and blinking, press the "SET" button, at this time, the system enters the degrees Fahrenheit and Centigrade temperature selection function, indicating the temperature of the window shows the current status. Press "▲" or "▼" key to change the temperature selection status. It expressed as degrees Celsius temperature value If set to $^{\circ}\text{C}$; it shows as degrees Fahrenheit temperature if set to $^{\circ}\text{F}$

CARE OF TIPS

 **Caution:** The soldering iron or tweezer can reach very high temperatures. Be sure to turn the unit off prior to carrying out any maintenance or trouble shooting steps listed below.

IMPORTANT

Remove the tip and clean after moderate to heavy use or at least daily for light usage. Remove any loose build up in the tip retaining assembly to prevent tip freezing.

The solder tips supplied are iron clad cooper and if used properly, they should maintain optimum life.

1. Always tin the tip before returning it to the holder, turning off the station, or storing it for long periods of time. Wipe the tip on a brass cleaner prior to use.
2. Keeping the iron set at high temperatures (more than 400°C or 750°F) will shorten tip life.
3. Does not use excessive pressure to the tip or rub the joint with the tip while soldering; it does not improve the heat transfer and may damage the tip.
4. Apply solder to the joint, not the tip when soldering. The flux is naturally caustic and thus will eat away the tip.
5. Never clean the tip with a file or abrasive materials.
6. Do not use fluxes which contain chloride or acid. Use only rosin or resin activated fluxes.
7. If an oxide film forms on the tip, it can be removed by careful buffing with a 600-800 grit emery cloth, isopropyl alcohol or equivalent and then wrapping rosin core solder around the newly exposed surfaces. Coat the tinned areas with rosin-core solder after the resin-core has melted.

NEW SOLERING IRON TIPS

Applying the following steps will lead to optimum life.

1. Flip the “**TWZ / SIA**” function switch on to the “**SIA**” position.
2. Turn the main power switch to the “**ON**” position.
3. Set temperature to min. then turn Coat the tinned surfaces with rosin-core solder after reaching 250°C (482°F).
4. Set to desired temperature after allowing the unit to idle at 250°C for 3 minutes.
5. The iron will be ready for use once it reaches the preset temperature.

IMPORTANT: Remove and clean the tip daily. If a new tip is installed, remove any loose build up in the barrel assembly, otherwise the tip may fuse to the heating element or retaining barrel.

MAINTENANCE

TIP MAINTENANCE AND DRESSING

Tips can be changed or replaced simply by unscrewing the knurled nut barrel assembly. The station must be switched off and allowed to cool before this operation as damage may result if the system is left on without the tip in place!

After removing the tip, blow out any oxide dust that may have formed in the tip retaining area of the barrel. Be careful to avoid getting this dust in your eyes. Replace the tip and screw back the knurled nut barrel assembly using only firm hand pressure to tighten. Pliers should only be used to tighten the nut to avoid burning your fingers, but care should be taken not to over-tighten as this could damage the element.

GENERAL CLEANING

The outer cover of the iron/tweezers and rework station may be cleaned with a damp







cloth using small amounts of liquid detergent. Never submerge the unit in liquid or allow any liquid to enter the case of the station. Never use any solvent to clean the case.

SERVICE

If the iron/tweezers or rework station should become faulty or, for some reason not operate normally, the system should be returned to the service department of your authorized dealer or service agent. Or a similarly qualified person in order to avoid a hazard.

INTERCHANGEABLE TIPS

TWEEZERS TIPS FOR TWZ80

| TIP TYPE | APPLY TO COMPONENT |
|---|--|
|    | <p>*Chip resistors</p> <p>*Chip capacitors</p> <p>*SOT</p> |
|    | <p>*Flat pack IC`s</p> <p>*Small outlet 8-24 pins</p> <p>*Flat package tunnel types</p> |

REPLACEMENT TIPS FOR 108ESD

