



Residual current operated circuit breaker, 2-pole, type F, selective, In: 80 A, 300 mA, Un AC: 230 V

Model	
product brand name	SENTRON
product designation	RCCB
design of the product	Selective
product type designation	5SV3
General technical data	
number of poles	2
size of installation devices according to DIN 43880	1
mechanical service life (operating cycles) typical	10 000
short-circuit current of series fuse maximum permissible	80 A
short-circuit current rating	10 kA
switching function short-term delayed	No
overvoltage category	III
Supply voltage	
supply voltage for testing equipment minimum	100 V
value range of the supply voltage frequency	50 Hz
value range of the operating frequency	50/60 Hz
value range of the supply voltage at AC	230/400 V
Protection class	
protection class IP	IP20, if the distribution board is installed, with connected conductors
Switching capacity	
switching capacity current	
• according to IEC 61008-1 rated value	0.8 kA
Dissipation	
power loss [W]	
• for rated value of the current at AC in hot operating state per pole	3.9 W
• maximum	7.8 W
Product details	
product feature silicon-free	Yes
product extension installable supplementary devices	Yes
Connections	
connectable conductor cross-section solid	
• minimum	0.75 mm ²
• maximum	35 mm ²
connectable conductor cross-section stranded	
• minimum	0.75 mm ²
• maximum	35 mm ²
tightening torque with screw-type terminals	
• minimum	2.5 N·m

• maximum	3 N·m
position of power supply cord	top or bottom





Mechanical Design

height	90 mm
width	36 mm
depth	70 mm
installation depth	70 mm
number of modular width units	2
fastening method	DIN rail (REG)
mounting position	any
grid spacing	60 mm
net weight	200 g

Environmental conditions

ambient temperature during operation	
• minimum	-25 °C
• maximum	45 °C
ambient temperature during storage minimum	-40 °C
number of test cycles for environmental testing according to IEC 60068-2-30	28

Approvals Certificates

General Product Approval		Declaration of Conformity			
Confirmation		Miscellaneous			

Test Certificates	other	Railway	Dangerous Good
-------------------	-------	---------	----------------

Miscellaneous	Confirmation	Miscellaneous	Confirmation	Vibration and Shock	Transport Information
-------------------------------	------------------------------	-------------------------------	------------------------------	-------------------------------------	---------------------------------------

Environment

[Environmental Confirmations](#)

Further information

Siemens has decided to exit the Russian market (see here).
<https://press.siemens.com/global/en/pressrelease/siemens-wind-down-russian-business>

Siemens is working on the renewal of the current EAC certificates.
 Please contact your local Siemens office on the status of validity of the EAC certification if you intend to import or offer to supply these products to an EAC relevant market (other than the sanctioned EAEU member states Russia or Belarus).

Information on the packaging
<https://support.industry.siemens.com/cs/ww/en/view/109813875>

Information- and Downloadcenter (Catalogs, Brochures,...)
<http://www.siemens.com/lowvoltage/catalogs>

Industry Mall (Online ordering system)
<https://mall.industry.siemens.com/mall/en/en/Catalog/product?mlfb=5SV3617-7>

Service&Support (Manuals, Certificates, Characteristics, FAQs,...)
<https://support.industry.siemens.com/cs/ww/en/ps/5SV3617-7>

Image database (product images, 2D dimension drawings, 3D models, device circuit diagrams, ...)
http://www.automation.siemens.com/bilddb/cax_en.aspx?mlfb=5SV3617-7

CAX-Online-Generator
<http://www.siemens.com/cax>

Tender specifications
<http://www.siemens.com/specifications>

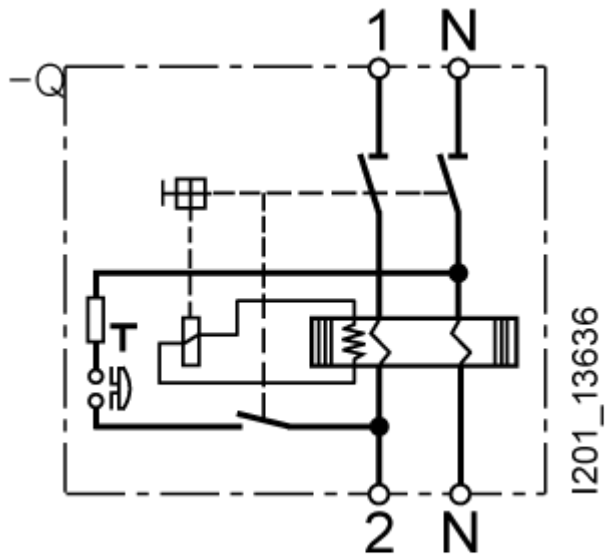
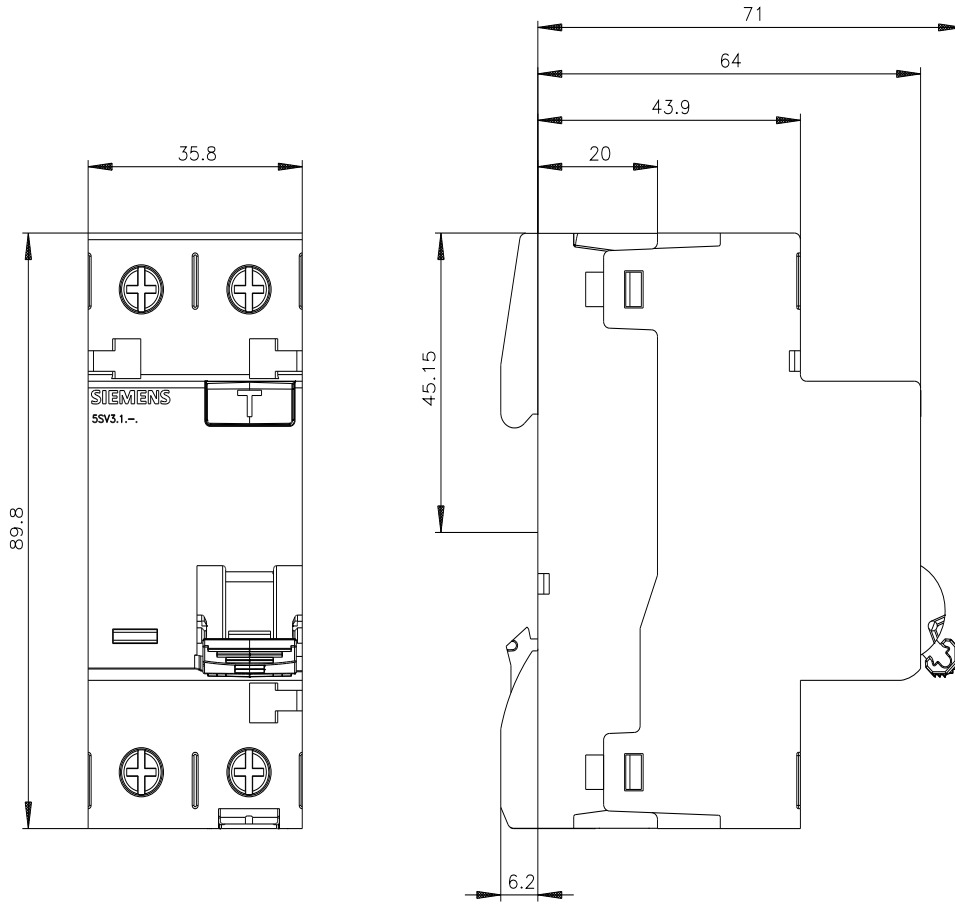

-CB

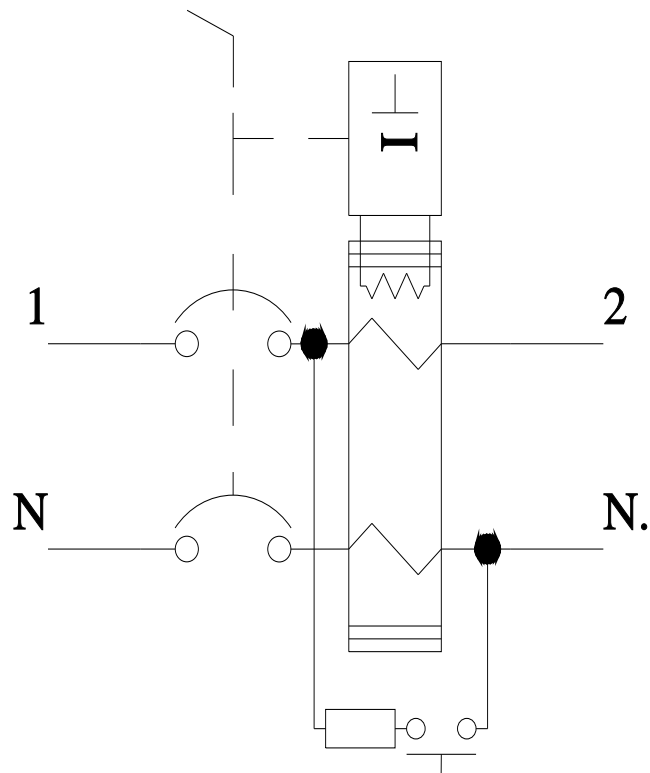

last modified:

8/15/2023 