

USING THE CIRCUITMASTER 4000M PRECISION ACTIVE OSCILLOSCOPE FOR CIRCUIT ANALYSIS



Introduction

The **CircuitMaster 4000M Precision Active Oscilloscope** is unlike any other oscilloscope, and provides some innovative test and measurement functions which enable engineers to perform several new types of circuit analysis. This article shows how the **CircuitMaster** can be used to investigate problem circuits

The **CircuitMaster 4000M Precision Active Oscilloscope** is designed for safe probing of closely spaced components by adding precision DC measurement, signal storage and analysis functions to a traditional oscilloscope design. In

addition, the **Active** mode allows signals to be injected into the board when required, allowing circuit conditions such as drive strength and source impedance to be checked that are not possible with traditional oscilloscopes. The **CircuitMaster** even has a built-in **LogicView** 4 channel logic analyser for logic signal display as well as the 2 analogue inputs. **FirmFlex** and **VI Curve** functions provide impedance signature analysis on powered and unpowered boards.



There are several situations where the CircuitMaster wins over conventional equipment because of its extra functions. Let's have a look at some examples: -

Keep your eyes on the job!

Look at the traditional way of doing oscilloscope measurements from several test points on a PCB: -

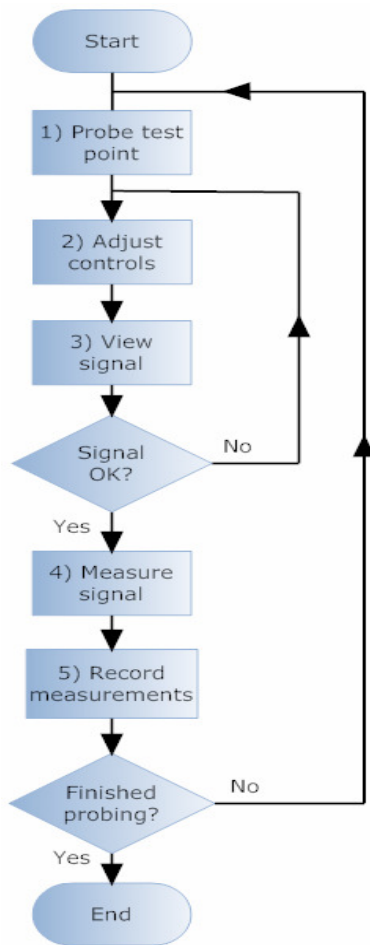

At step 1, the engineer has a clear view of the test point while probing.

In steps 2 and 3, the engineer is adjusting the oscilloscope to get the best waveform. During this time he has to take his eyes off the probe while holding the probe in place.

In steps 4 and 5, the engineer is recording the results from the displayed waveform. During this time he can no longer look at the probe, and may need to use another hand for writing or using a keyboard.

The need to look away from the probe can cause invalid or inaccurate measurements (at best) or damage to the circuit (if pins are shorted when the probe slips).

USING THE CIRCUITMASTER 4000M PRECISION ACTIVE OSCILLOSCOPE FOR CIRCUIT ANALYSIS

We need to separate signal acquisition and signal analysis. Now let's have a look how the CircuitMaster does it :-

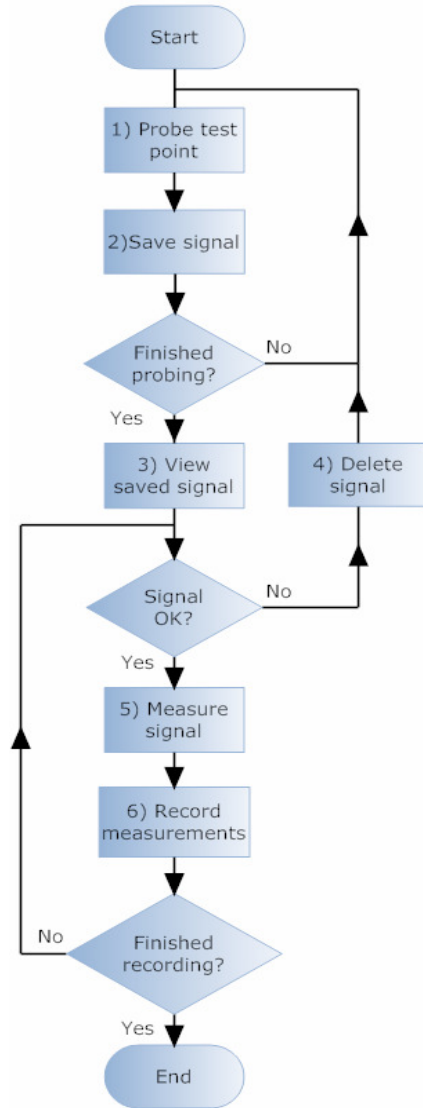

At step 1, the engineer has a clear view of the test point while probing.

In step 2, the engineer uses the foot switch to auto range the **CircuitMaster** and save the signal in the **WaveStack** memory. He still has a clear view of the probe while doing this.

This probe/save cycle is repeated until all test points have been acquired. The probe can then be removed from the board.

In step 3, the engineer looks at the saved signal to confirm that it is suitable for analysis. If necessary it can be deleted and re-acquired by repeating steps 1 and 2.

In steps 5 and 6 the signal is measured, using on screen cursors or automatic measurements, and the results are recorded

The measurement/record cycle is repeated until all acquired signals have been analysed.

Here you can see the WaveStack in use, showing 4 ► stored waveforms in addition to the live signal. You can use the Review control to choose which waveform to view on the main display, and the measurements and DVM readings for that waveform will be shown.

This shows how separating the acquisition and analysis makes circuit investigation quicker, more accurate and more reliable. The CircuitMaster can store up to 40 signals in its WaveStack, including all signal parameters and DC voltage levels, all at the press of a foot switch leaving hands and eyes free for concentrating on the board under investigation.

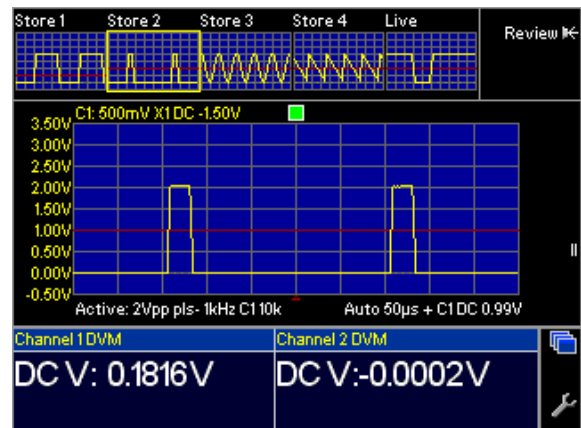



USING THE CIRCUITMASTER 4000M PRECISION ACTIVE OSCILLOSCOPE FOR CIRCUIT ANALYSIS

Spot the difference!

Switch your traditional oscilloscope on and set to 1V/div. It's no surprise to see a flat line at 0V. Now connect the probe tip to ground. Result? No difference, still a flat line at 0V. Try the same with a DVM with the probes apart and shorted – the reading is round about 0V in both cases. So here we have two of the most common test instruments giving the same readings for totally opposite conditions – open circuit and short circuit! Not really very useful is it?

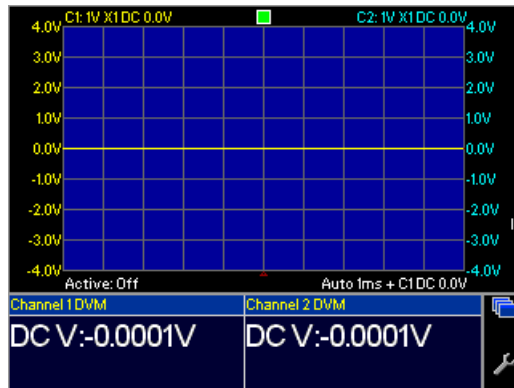

◀ Left picture
Results for open circuit probe. Note the flat trace at 0V and 0V DVM reading.

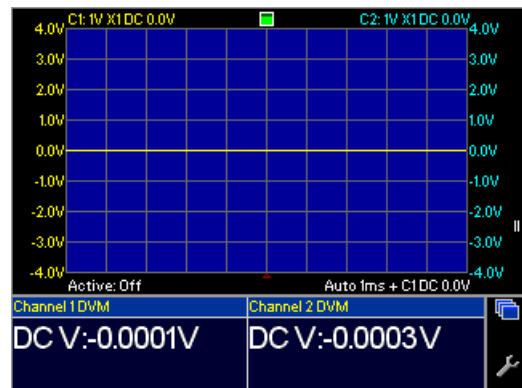

Right picture ▶
Results for short circuit probe. Can you see the difference?

Of course you can't – there isn't any! But that's not much use in a real circuit where a short to 0V may be a fault. So how does the CircuitMaster deal with this? Simple – it uses **Active** mode as in the next two traces: -

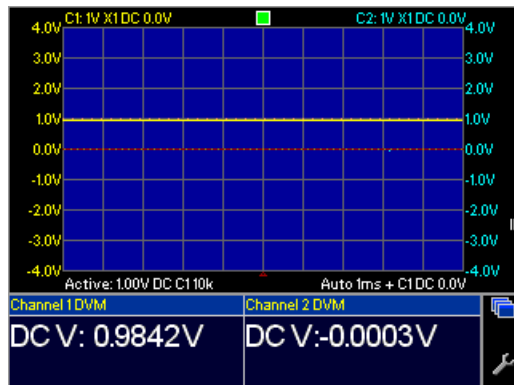

◀ Left picture
Results for open circuit probe in **Active** mode with a 1V/10k active load.

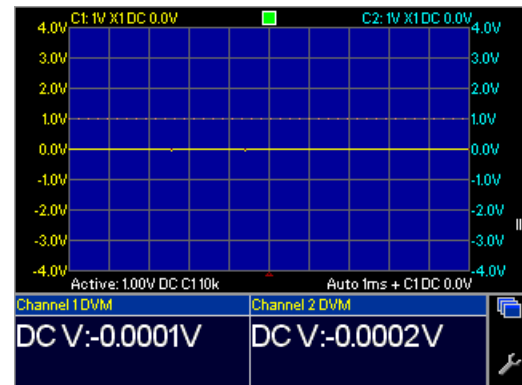

Right picture ▶
Results for short circuit probe. Now you can clearly see the difference.

Let's explain. The CircuitMaster uses **Active** mode to impose an active load on the probe, using a programmable voltage source in conjunction with a selectable series resistance. With an open circuit, the input voltage follows the active load voltage (1V nominal, actually 0.9842V measured by the DVM), but with a short circuit the input is still 0V as in the right hand picture.

Of course, you can use an ohmmeter to quickly find the difference, but only when no power is present – on a working powered board it is still important to know whether the 0V you are measuring is a direct connection to ground, a resistance to ground, a logic gate driving low, or an open circuit. If we turn off the power, the logic gate output will probably look like an open circuit on an ohmmeter, so we really need to investigate with the power on. By adjusting the active load voltage and resistance, you can easily see the difference between a logic low output and a short, by using the **CircuitMaster** to apply a pull up voltage to the test point.

With resistive connections to ground, you will see intermediate voltages depending on the relative value of the board resistance and the **Active** mode output resistance. You can adjust the voltage and/or resistance to get the best results. **Active** mode can also generate AC signals of various shapes and sizes, so it can be used to inject signals into your board like a function generator if you wish.

USING THE CIRCUITMASTER 4000M PRECISION ACTIVE OSCILLOSCOPE FOR CIRCUIT ANALYSIS

Rise to the occasion

The following block diagram is a simple example of a common situation in industrial electronics (e.g. the SMEMA interface standard <http://www.ipc.org/html/IPC-SMEMA-9851.pdf>), where a controller PCB drives signals off-board to a peripheral, using open-drain drivers or opto isolators with termination resistors to VCC on the peripheral board.

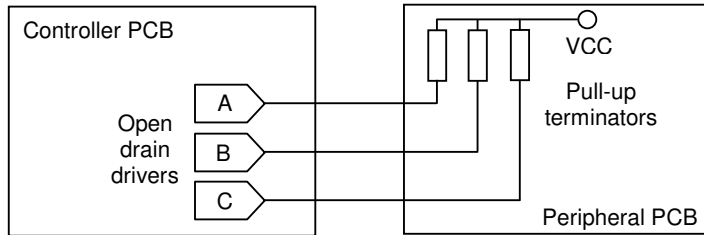

The drivers are often damaged by overload, static or voltage spikes.

On this board, one of the drivers on the controller PCB has a faulty open circuit output, one has a faulty short circuit output, and one is OK. We have the board powered up on a bench

and we need to diagnose the faulty drivers and replace them. Easy so far.

We configure the controller board so the inputs to the drivers have 2.5kHz clock signals running, then use an oscilloscope to look at the outputs. Result? Horizontal lines at 0V on all three outputs! But one driver is working, and the other two have totally different faults. How can we find out which is which?

You've guessed it – with the **CircuitMaster** in **Active** mode! The active output is set to 5V with a 1k resistance, to replace the pull up resistors normally on the peripheral board

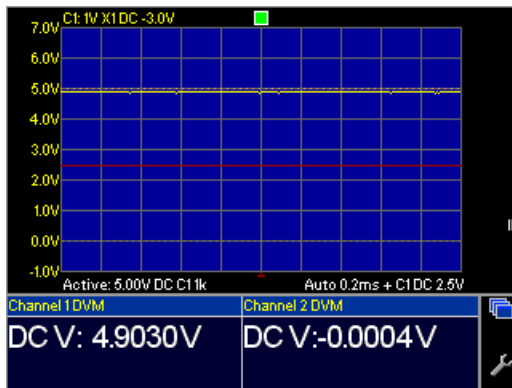

◀ Here is the result for the driver with a faulty open circuit output. The output is pulled to 5V by the active pull-up in the CircuitMaster, and the results is a horizontal line at 5V and a 5V (approx) DVM reading.

Next, the result ▶ for the driver with a faulty short circuit output. Here, the faulty output maintains a 0V level, overcoming the

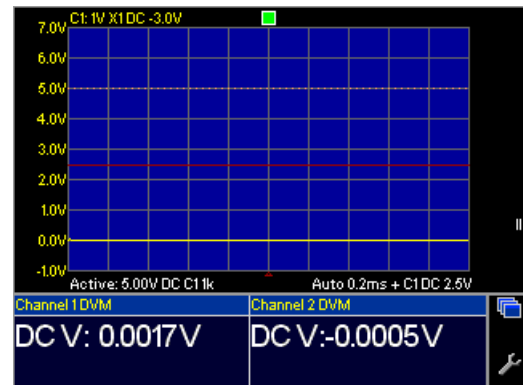

active pull up. The oscilloscope trace and DVM reading clearly show this.

◀ Finally, the result for the good output. The 5V active pull up allows the normal high logic level to be achieved, and the driver 2.5kHz output signal can be clearly seen.

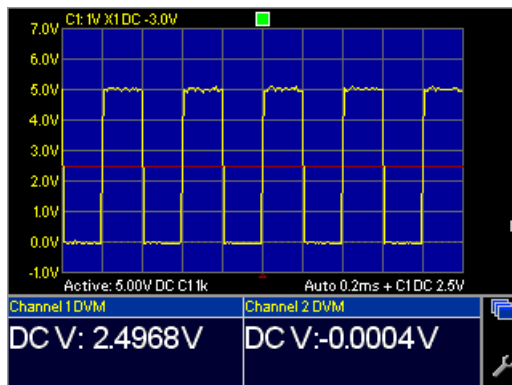

The **CircuitMaster** uses **Active** mode here to provide a pull up for the signal. The pull up resistance can be 100R to 1M in decade steps, and the pull up voltage can be up to 10V in 0.1V steps. Working with ECL? Or with exotic serial communication protocols? The pull up voltage can also be adjusted down to -10V for less common applications, in effect providing a pull down facility.

Many engineers will cobble together an external circuit for dealing with this situation – with the **CircuitMaster** this is not necessary, as the features you need are built-in.

USING THE CIRCUITMASTER 4000M PRECISION ACTIVE OSCILLOSCOPE FOR CIRCUIT ANALYSIS

DC or not DC? – that is the question

Have a look at this precision DC circuit. Here, a REF191 voltage reference IC is used to generate a 2.048V reference voltage, and a precision op amp is used to multiply this voltage by 2 to give 4.096V. Both voltages can be measured at test points TP1 and TP2.

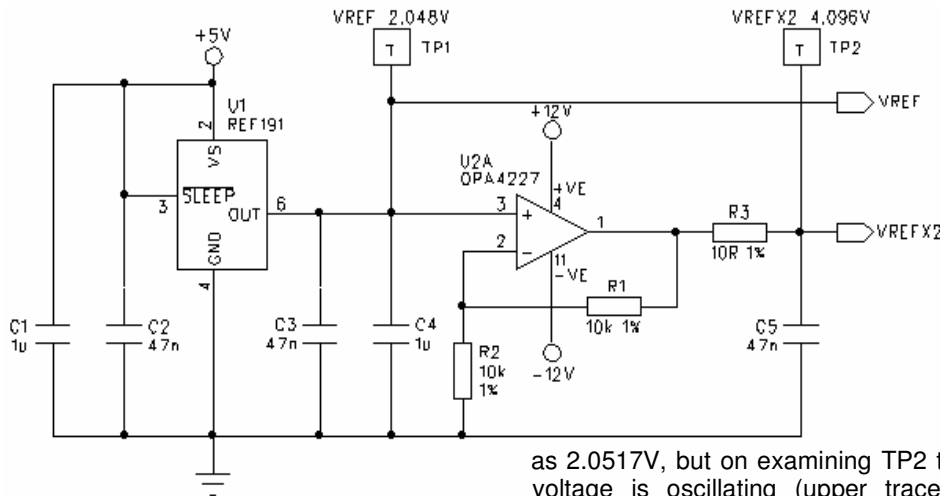

Using a DVM, the voltage at TP1 measures correctly at 2.052V (which is within tolerance), but at TP2 something very strange is happening. The test point voltage measures about 4.1V but the DVM reading is unstable – the last couple of digits are changing all the time. What's going on?

Let's have a look with the **CircuitMaster** in standard mode. Channel 1 DVM (lower trace) shows the TP1 reading

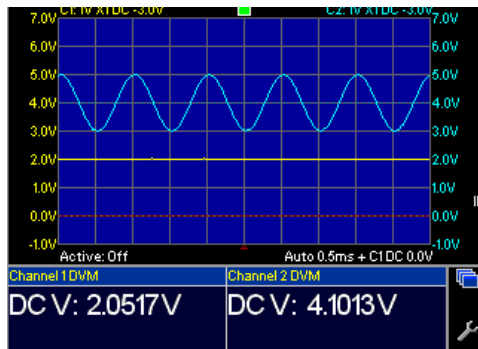

as 2.0517V, but on examining TP2 the problem becomes clear – the voltage is oscillating (upper trace) because the op amp U2 is unstable. The DVM measures the **average** voltage, which **looks** correct, but the oscilloscope shows the oscillating signal clearly

◀ Here's what the **CircuitMaster** shows! Whoever built the board is in trouble! The resistor R3 is there to isolate the capacitor C5 from the op amp output, but R3 has been fitted with a 1R resistor instead of 10R, and C5 is causing the op amp to oscillate. This is a common problem in DC circuit and shows why you should never just use a DVM for analysis. The DVM readings on the **CircuitMaster** both appear correct, but only by looking at the oscilloscope trace can you see that the circuit is not working as it should.

Next question – suppose a 100R resistor was fitted instead of 10R. The DVM would still show the correct readings (depending on the loading on VREFX2), but the board is still faulty. How do we detect this condition with the **CircuitMaster**?

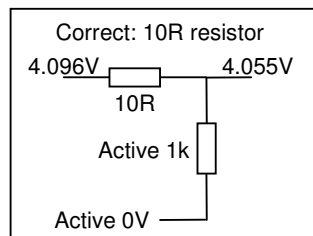

Easy! Use **Active** mode to measure the test point TP2. Set the active voltage to 0V and the impedance to 1k.

◀ On a good board with a 10R resistor, the nominal 4.096V output voltage will be divided down slightly by the 1k load, giving a voltage of 4.055V.

However, if a 100R resistor is fitted, the voltage will be divided down to 3.724V – a substantial difference which immediately identifies the fault.

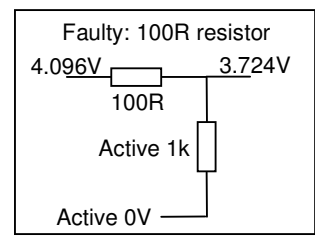

This example shows how useful the **CircuitMaster** really is. With one measurement on a single test point, we have found an incorrect value resistor and/or an oscillating op amp. With traditional equipment, you would have to use a DVM to check the DC accuracy, because a normal oscilloscope is not accurate enough for precision DC measurements. But with a DVM, the oscillation does not show up. To detect the incorrect resistor value, you would have to power down the board and use an ohmmeter.

So you would need three different measurements with two different instruments, with power on and off, to analyse this circuit – with the **CircuitMaster** all the information is available from a single measurement!

USING THE CIRCUITMASTER 4000M PRECISION ACTIVE OSCILLOSCOPE FOR CIRCUIT ANALYSIS

Call in the KGB

Your job is board testing. You are viewing a signal from the board under test, and you have to decide whether the signal is correct. So, you set up the **CircuitMaster** automatic measurements to give you the information you want about the signal.

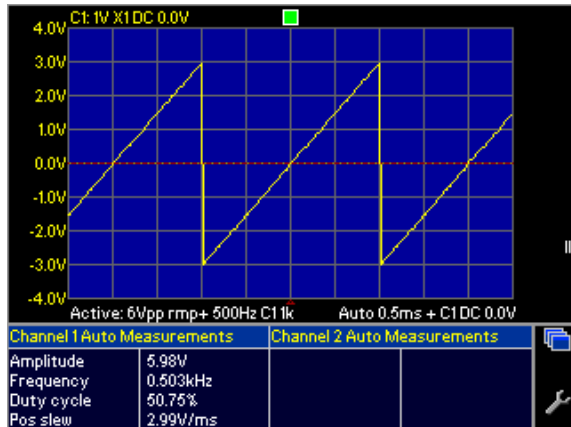

◀ Here, we are looking at a ramp waveform, and we have set up the **CircuitMaster** to measure the amplitude, frequency, duty cycle and slew rate, with the following results: -

- Amplitude 5.98V
- Frequency 503Hz
- Duty cycle 50.75%
- Positive slew rate 2.99V/ms

You can now compare these values against the expected values for your circuit to confirm that the signal is correct. This is a sophisticated and reliable test method, but takes time to set up and to analyse the results.

So is there a quicker way? Well, you guessed it, there is! This is where the KGB comes in. KGB means **Known Good**

Board, and is a very quick and highly effective test technique. If you have a working board (also sometimes called a **Golden Board**), you can use the **CircuitMaster** to compare the signals on your board with your known good board, saving time and eliminating errors cause by misunderstanding or misreading of the results.

On the right, we have stored the signal from the KGB ▶ (red), and the actual channel 1 signal is displayed in yellow. The CircuitMaster builds a mask using the vertical and horizontal tolerances shown on the menu, and compares the two waveforms. In this case, you can see the compare result is 82% (measured by how much of the signal falls within the mask) and the result is FAIL. You can see that the amplitude of the channel 1 signal (yellow) is slightly less than the stored signal (red) – hence the fail result.

This provides a very good method of checking that a signal is correct without having to compare numerical measurements, which are often a source of error or misunderstanding.

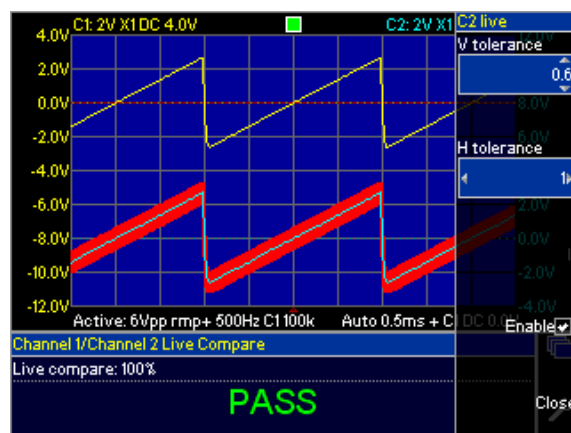
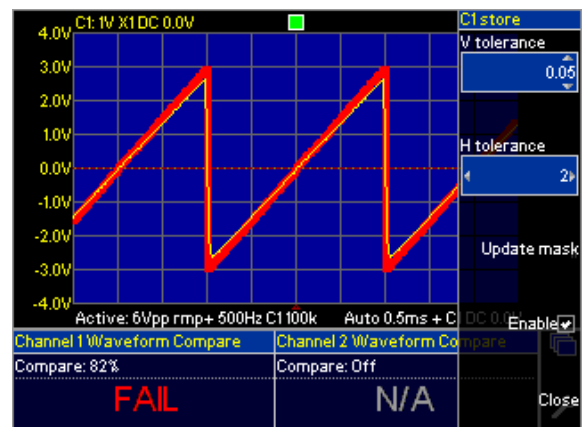

◀ In addition to comparing with stored waveforms, you can also compare channel 1 with channel 2 directly using **Live Comparison** mode. Here, the **CircuitMaster** assumes that the channel 1 signal (top trace) is a known good signal, and it compares the channel 2 signal (lower trace) against it, using a tolerance mask derived from the channel 1 signal. Note here we are using quite a large vertical tolerance but a tight time tolerance – this would be the case if the amplitude (vertical axis) of a signal is not so critical, but the correct frequency (horizontal axis) is important.

In summary, the **CircuitMaster** contains advanced signal measurement functions, both voltage related (e.g. amplitude, mean, rms, overshoot) and time related (e.g. period, frequency, rise time, slew rate) which are highly useful for signal analysis. However when testing boards, the compare

functions allow a signal to be directly compared against a **Known Good Board** for rapid PASS/FAIL decisions.

USING THE CIRCUITMASTER 4000M PRECISION ACTIVE OSCILLOSCOPE FOR CIRCUIT ANALYSIS

Keep out of no man's land

In logic circuits, a very common way of identifying a fault is to spot a signal which is not a proper digital logic level. This used to be easy, when all signals were TTL on 5V supplies. But nowadays all manner of different logic standards exist, often on the same board, and spotting the tell-tale signs of invalid logic levels is more difficult. The **CircuitMaster** has adjustable logic thresholds, so you can easily see whether a signal is valid or not.

Here we see a display with logic thresholds enabled. We ▶ have set the high threshold to 2.4V and the low threshold to 0.6V. On the left of the waveform, a bar graph is displayed showing valid high levels in red (from 2.4V to 5V) and low levels in green (0V to 0.6V). The region in between is “**no man's land**” as signal in this area are not valid logic levels and may represent a vault.

The signal here is a CMOS 5V logic signal and as you can see it had good logic levels in both the high and low states.

In addition, we are here using the vertical time cursors to measure the period of the waveform – the results below the display show the time from each cursor to the trigger, the time difference (delta) and the corresponding frequency (1/delta)

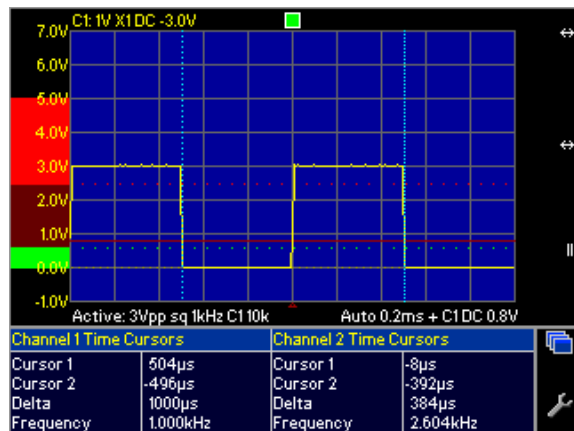
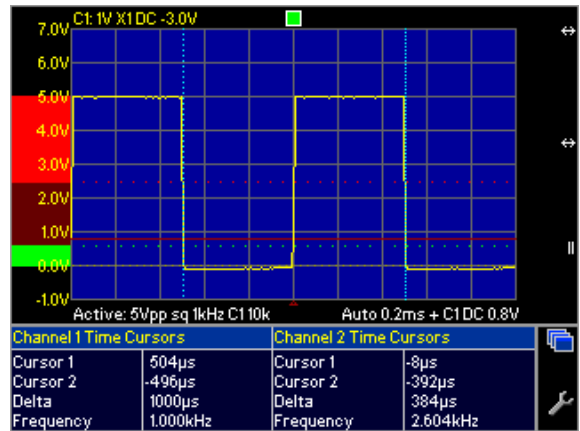

◀ Here, with the same thresholds, is a 3V logic signal. You can clearly see that this signal is still valid with our threshold settings. In a circuit with 3V and 5V logic standards, this signal would be compatible with both standards and may well be found in the interface between the two types of logic ICs on your board.

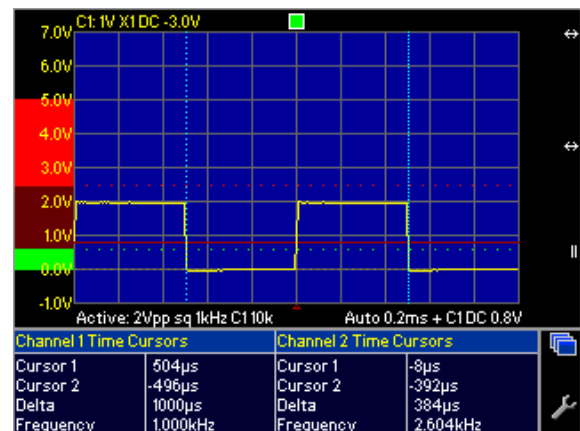

On the third waveform (on the right), an invalid signal is ▶ shown. Here the high logic level is only about 2V, which is below the valid high level threshold as can be clearly seen on the display. The high level is in “**no man's land**” and may well be due to an overloaded output, bus contention in a tri-state circuit, or a faulty IC output.

With the threshold display you can clearly see invalid logic levels and quickly identify faults. But the thresholds are not just there for logic signals. You can also use them for setting a pass band for signal measurements – in this case a signal in the middle region would be regarded as good, and in the high or low regions as bad. The thresholds can be set in the range -12V to +12V, so you can also use them for other types of digital signals (such as RS-232 serial communications) with non-standard logic levels.



USING THE CIRCUITMASTER 4000M PRECISION ACTIVE OSCILLOSCOPE FOR CIRCUIT ANALYSIS

And much, much more!

We've seen a lot so far, but there's still more you can do with the **CircuitMaster**. Here are some more examples: -

When the heat is on

Sometimes you can't do power-on testing on a board. It may have a short circuit or an overloaded output, so when you power it up it gets hot or overloads your power supply, risking further damage as components overheat. In this situation, you can use the **VI test** method to help find the fault without applying power to the board. VI testing applies a controlled AC signal, through a selectable source impedance, to a component on the board under test, and a graph of current against applied voltage is plotted. The shape of this curve, especially when compared to a KGB (known good board, see above), can be used to find faulty components and short circuits. The **CircuitMaster** storage and compare functions (**WaveStack**, stored and live comparison, tolerance masks) can also be used

I've got cramp

Multiple test point signal measurements involve a lot of probing which can be tiring. With the **MultiWay** function, you can acquire up to 40 signals at once using a built-in multiplexer and a special cable. The signals are stored in the **WaveStack** for review and inspection after acquisition. Various sizes of IC test clip can be used, and you can also make up cables to attach to interface connectors or edge connectors on your board. Not only that, a split mode enables up to 20 signals to be compared live with the same 20 signals from a second board.

Take a logical view of things

You are working on a mixed signal circuit, with a serial digital to analogue converter IC. The input signals to the DAC are logic signals, and the output is an analogue voltage. You want to look at the timing of the serial control signals and their relationship with the DAC output voltage. With the **LogicView** function, you can look at up to 4 digital signals in addition to the 2 analogue signals, all with the same timing relationship, so in effect you can have 6 signals on the display at once. LogicView is in effect a 4 channel logic analyser, with variable threshold, which can be used to good effect in mixed signal circuits.

Drifting apart

The **CircuitMaster** is quite capable of showing fast moving events, up to 100MHz, and showing fast rising edges in fine detail. But not all things are quite so fast. In precision DC circuits, thermal effects often cause drift and slow changes in voltage. Here, the DVM comes into its own. In addition to the measured voltage, the DVM also calculates the maximum, minimum and average voltage over time. These statistics (reset when changing range) show how your circuit behaves as it warms up from a cold start.

Time for your injection

A classic fault-finding technique is to inject a signal into a circuit, from a signal generator or function generator, then use an oscilloscope to trace the signal through the circuit to identify where things go wrong. With the **CircuitMaster**, you don't need separate instruments for signal injection and signal tracing – in AC **Active** mode you can configure the built-in function generator to generate sine, square, triangle, ramp and pulse signals up to 50V pk-pk, which you can inject into your circuit via one channel (in this case used as an output). With the other channel (used as an input) you can follow the signal and quickly see where it disappears. Nothing new here, except that all you need is in one box, removing the need for a separate instrument in complex interconnecting cables.

The CircuitMaster Precision Active Oscilloscope

The CircuitMaster does exactly what it says on the screen.

Precision: 0.1% accurate DC voltmeter for precision far in excess of a conventional oscilloscope.

Active: DC and AC voltage generator for active signal injection, programmable loading, bias and pull up voltages.

Oscilloscope: 100MHz DSO, 2 channels plus external trigger, all usual oscilloscope functions.

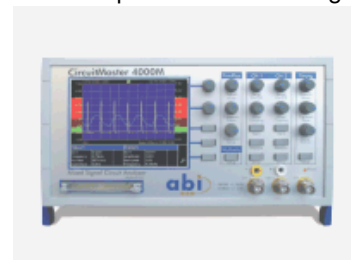

Ian Fletcher, Director, 14th June 2007