



Datasheet

Stock No: 311-9359

ENGLISH

RS Pro 2m power cord, C5 to UK Plug (BS 1363), 2.5 A, 250 V



Product Details:

IEC C5 Leads (2.5A)

Brought to you under the trusted RS Brand, this power cord has a C5 socket fitted with a UK plug, and is commonly used in applications such as laptop computers and portable projectors. The C5 connector is sometimes referred to as a "clover leaf" connector due to its unique shape.



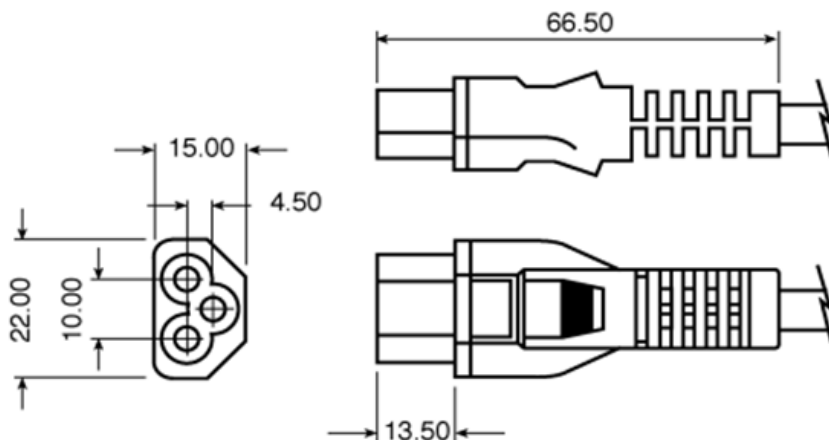



Standards: BS 4491: 1989, BS1363A, IEC 320 std 5, EN60320 std 5





Specifications:

Connector A:	C5
Connector B:	UK Plug
Length:	2m
Current Rating:	2.5 A
Sheath Colour:	Black
Voltage Rating:	250 V
Connector A Gender:	Female
Connector A Type:	IEC
Connector B Gender:	Male
Connector B Type:	BS 1363
Connector A Angle:	Straight
Connector B Angle:	Straight

	C3	C4		C13	C14
	C5	C6		C15	C16
	C7	C8		C19	C20

IEC to BS1363 Plugs

A range of electrical appliance connecting leads, the majority of which are terminated with connectors that conform to IEC 60320. The IEC (International Electrotechnical Commission) is the international standards and conformity assessment body. The drawing illustrates the range of connector types offered within this section - The 'odd' 'C' numbers refer to a socket type connector - mains input - and the 'even' 'C' numbers refer to a plug type connector - the appliance inlet. The current rating detailed in the price table refers to the rating of the lead and plug as supplied. It does not necessarily refer to the current carrying capacity of the lead by itself.