

Angle seat valve VZXF

FESTO



Angle seat valve VZXF

Key features



FESTO

Function

Angle seat valves are externally actuated valves. These valves are actuated by a direct supply of compressed air. In this process, the seat of the process valve is raised by means of a pneumatic actuator. In the normal position, the valve is closed by a spring. When the actuator is subjected to operating pressure, it raises the actuating piston and, at the same time, the valve disc too – the

valve opens. The valve seat is slanted at an angle of approx. 50° in relation to the medium flow. The direction of flow is determined by the design of the valve. Angle seat valves are used in applications in which absolute purity of the medium cannot be ensured, in which highly viscous media are to be controlled or in steam applications.

Design

-  - Connecting thread
G½ ... G2
-  - Flow rate Kv
2.8 ... 47.5 m³/h
- Gunmetal (red brass) variant
- Stainless steel casting variant
- Stainless steel casting variant with nickel-plated actuator head

General

- Angle seat valves are simple and sturdy and are thus perfectly suitable for almost all media with a viscosity of up to 600 mm²/s
- Angle seat valves control suitable gaseous and liquid media in rigid piping systems without the need for any pressure differential
- No pressure differential required between the inlet and outlet
- Low flow resistance
- Insensitive to steam or slightly contaminated media
- Long service life
- Low maintenance
- The valves have a high chemical and thermal resistance by virtue of their design
- The N/C function ensures that the valve is closed in the event of pressure loss in the control circuit
- Different designs of angle seat valves are available depending on the pressure of the medium
- There is a choice of two versions: “closing in the direction of medium flow” is used for gaseous media; “closing against the direction of media flow” is used for liquid media

Explosion protection

- ATEX-certified is used in production areas which are potentially explosive to a certain extent. The VZXF angle seat valves are certified for use in equipment group II, category 2

PWIS-free

- PWIS-free is chosen for use in production areas in which the influence of paint-wetting impairment substances must be avoided at all costs

Vacuum version

- The variant that is suitable for vacuum is used in packaging machines which need to generate a vacuum

Angle seat valve VZXF

Key features

FESTO

Variants

VZXF-L-...-M-A-G112-350-H3B1-50-8

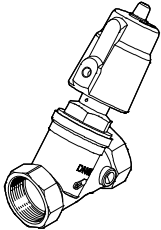

VZXF-L-...-M-A-G112-350-M1-V4V4T-50-7

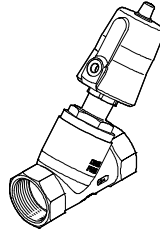

VZXF-L-...-M-A-G12-120-M1-H3B1-50-16

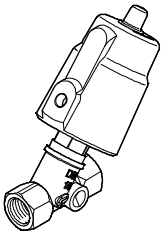

VZXF-L-...-M-B-G12-130-M1-V4V4T-50-40

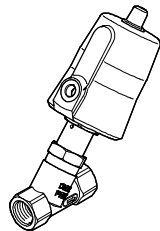

VZXF-F-L-...-M-B-G2-430-H3B1-50-3

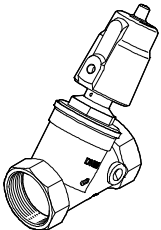



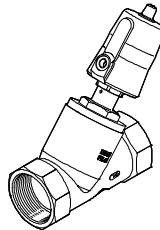



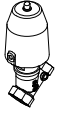

VZXF-F-L-...-M-B-G2-450-M1-V4V4T-50-3

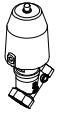

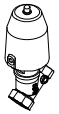

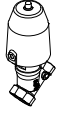



Angle seat valve VZXF

Product range overview

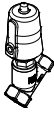
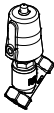
Version	Type	Process valve connection	Nominal size DN	Temperature of medium [°C]	Flow rate Kv [m³/h]	Process valve nominal pressure PN	→ Page/Internet
Gunmetal (red brass)							
	VZXF-L-...-H3B1-...	G½	15	-10 ... +80	2.8 ... 33.8	16	8
		G¾	20				
		G1	25				
		G1¼	32				
		G1½	40				
		G2	50				
	VZXF-L-...-H3B1T-..., VZXF-L-...-H3ALT-...	G½	15	-40 ... +200	3.5 ... 40	16	11 
		G¾	20				
		G1	25				
		G1¼	32				
		G1½	40				
		G2	50				
Gunmetal (red brass), vacuum version							
	VZXF-L-...-H3B1V-..., VZXF-L-...-H3ALV-...	G½	15	-10 ... +80	3.5 ... 40	16	15 
		G¾	20				
		G1	25				
		G1¼	32				
		G1½	40				
		G2	50				
Gunmetal (red brass), PWIS-free							
	VZXF-L-...-H3B1V-...	G½	15	-10 ... +80	3.7 ... 16.5	16	18 
		G¾	20				
		G1	25				
		G1½	40				
Gunmetal (red brass) with EX certification							
	VZXF-L-...-H3B1V-...-EX4	G½	15	-10 ... +80	3.5 ... 28	16	20 
		G¾	20				
		G1	25				
		G1¼	32				
		G1½	40				
		G2	50				

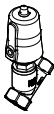
Angle seat valve VZXF

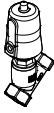
Product range overview

Version	Type	Process valve connection	Nominal size DN	Temperature of medium [°C]	Flow rate Kv [m³/h]	Process valve nominal pressure PN	→ Page/Internet
Stainless steel casting							
	VZXF-L-...-V4V4T-...	G1/2	15	-40 ... +200	2.8 ... 47.5	40	24
		G3/4	20				
		G1	25				
		G1 1/4	32				
		G1 1/2	40				
		G2	50				
Stainless steel casting with nickel-plated actuator head							
	VZXF-L-...-V4B2V-..., VZXF-L-...-V4ANT-...	G1/2	15	-40 ... +200	3.5 ... 40	40	28 
		G3/4	20				
		G1	25				
		G1 1/4	32				
		G1 1/2	40				
		G2	50				
Stainless steel casting, vacuum version							
	VZXF-L-...-V4B2V-..., VZXF-L-...-V4ANV-...	G1/2	15	-10 ... +80	3.8 ... 43	40	32 
		G3/4	20				
		G1	25				
		G1 1/4	32				
		G1 1/2	40				
		G2	50				
Stainless steel casting with EX certification							
	VZXF-L-...-V4V4T-...-EX4	G1/2	15	-40 ... +200	3.3 ... 34.5	40	36 
		G3/4	20				
		G1	25				
		G1 1/4	32				
		G1 1/2	40				
		G2	50				

Angle seat valve VZXF

Type codes

VZXF - L - M22C - M - A - G12 - 120 -

Type

VZXF	Angle seat valve, externally actuated
------	---------------------------------------

Type of directional control valve

L	In-line valve
---	---------------

Valve function

M22C	2/2-way valve, normally closed
------	--------------------------------

Reset method for monostable valves

M	Mechanical spring
---	-------------------

Media flow

A	Above valve seat for gaseous media
B	Below valve seat for gaseous and liquid media

Process valve connection

G12	Thread G1/2
G34	Thread G3/4
G1	Thread G1
G114	Thread G1 1/4
G112	Thread G1 1/2
G2	Thread G2

Nominal width

120	12 mm
130	13 mm
160	16 mm
180	18 mm
230	23 mm
240	24 mm
290	29 mm
310	31 mm
350	35 mm
430	43 mm
450	45 mm

Temperature range of medium

	Standard, -10 ... +80 °C
M1	-40 ... +200 °C

Angle seat valve VZXF

Type codes

		H3	B1		-	50	-	16	-		-	EX4
Housing material												
H3	Gunmetal (red brass)											
V4	Stainless steel											
Housing, actuator material												
AL	Aluminium											
AN	Nickel-plated aluminium											
B1	Brass											
B2	Nickel-plated brass											
V4	Stainless steel											
Sealing materials												
	Standard, NBR											
T	PTFE											
V	FPM											
Actuator size												
50	50 mm											
80	80 mm											
Medium pressure												
V	-0.9 ... 0 bar											
3	Max. 3 bar											
4	Max. 4 bar											
5	Max. 5 bar											
6	Max. 6 bar											
7	Max. 7 bar											
8	Max. 8 bar											
9	Max. 9 bar											
10	Max. 10 bar											
12	Max. 12 bar											
16	Max. 16 bar											
20	Max. 20 bar											
22	Max. 22 bar											
25	Max. 25 bar											
40	Max. 40 bar											
Presence of paint-wetting impairment substances												
	Standard											
C	PWIS-free											
EU certification												
	None											
EX4	II 2GD											

Angle seat valve VZXF

Technical data – Gunmetal (red brass), temperature of medium –10 ... +80 °C

FESTO

Function

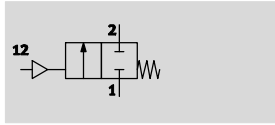

-  - Flow rate Kv
3.5 ... 28 m³/h

-  - Connecting thread
G¹/₂ ... G2



General technical data			
Process valve connection	G ¹ / ₂	G ³ / ₄	G1
Auxiliary pilot air port	G ¹ / ₈		
Nominal size DN	15	20	25
Nominal width [mm]	12	16	23
Valve function	2/2-way, closed, monostable		
Design	Poppet valve with spring return		
Type of mounting	In-line installation		
Mounting position	Any		
Direction of flow	Non-reversible		
Exhaust function	No flow control		
Sealing principle	Soft		
Reset method	Mechanical spring		
Type of actuation	Pneumatic		
Type of pilot control	Externally actuated		

Process valve connection	G ¹ / ₄	G ¹ / ₂	G2
Auxiliary pilot air port	G ¹ / ₈		
Nominal size DN	32	40	50
Nominal width [mm]	29	35	43
Valve function	2/2-way, closed, monostable		
Design	Poppet valve with spring return		
Type of mounting	In-line installation		
Mounting position	Any		
Direction of flow	Non-reversible		
Exhaust function	No flow control		
Sealing principle	Soft		
Reset method	Mechanical spring		
Type of actuation	Pneumatic		
Type of pilot control	Externally actuated		

Angle seat valve VZXF

FESTO

Technical data – Gunmetal (red brass), temperature of medium –10 ... +80 °C

Operating and environmental conditions			
Process valve connection	G1/2	G3/4	G1
Nominal pressure of process valve PN	16		
Operating medium	Compressed air to ISO 8573-1:2010 [7:4:4]		
Medium	Filtered compressed air, grade of filtration 200 µm		
	Mineral oil-based hydraulic oil		
	Inert gases		
	Mineral oil		
	Neutral fluids		
	Water		
Max. viscosity	[mm ² /s]	600	
Ambient temperature	[°C]	–10 ... +60	
Temperature of medium	[°C]	–10 ... +80	
CE marking (see declaration of conformity)	–		

Process valve connection	G1¼	G1½	G2
Nominal pressure of process valve PN	16		
Operating medium	Compressed air to ISO 8573-1:2010 [7:4:4]		
Medium	Filtered compressed air, grade of filtration 200 µm		
	Mineral oil-based hydraulic oil		
	Inert gases		
	Mineral oil		
	Neutral fluids		
	Water		
Max. viscosity	[mm ² /s]	600	
Ambient temperature	[°C]	–10 ... +60	
Temperature of medium	[°C]	–10 ... +80	
CE marking (see declaration of conformity)	To EU Pressure Equipment Directive		

Materials		
Angle seat valves		Material number
1 Housing	Gunmetal (red brass)	CC499K
2 Actuator head	Brass	–
3 Stem seal	NBR	–
	Seat seal	PTFE
– Note on materials	Contains paint-wetting impairment substances, RoHS compliant	–

Angle seat valve VZXF

Technical data – Gunmetal (red brass), temperature of medium –10 ... +80 °C

Dimensions

Download CAD data → www.festo.com

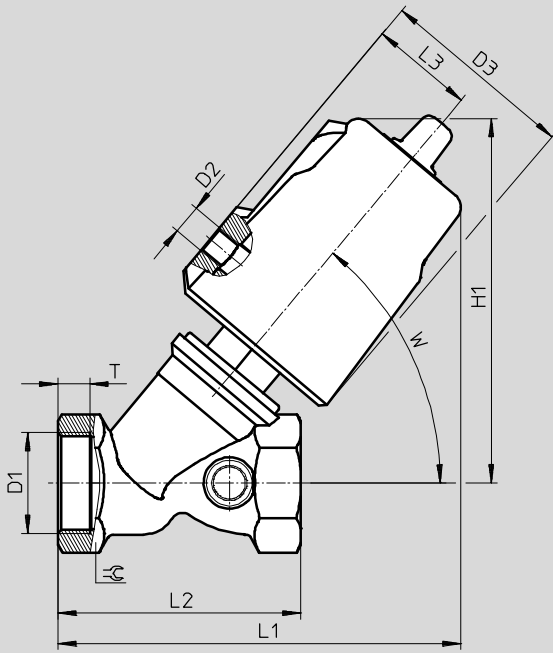

	D1	D2	D3 Ø	H1	L1	L2	L3	T	W	∠
VZXF-L-...-G12-...-H3B1-50-...	G½	G⅜	62	112	123	66	34	8	50°	27
VZXF-L-...-G34-...-H3B1-50-...	G¾			117	130	75		9		33
VZXF-L-...-G1-...-H3B1-50-...	G1			121	133	80		10.5		41
VZXF-L-...-G114-...-H3B1-50-...	G1¼			139	154	97		12.5		50
VZXF-L-...-G112-...-H3B1-50-...	G1½			145	161	107		14.5		56
VZXF-L-...-G2-...-H3B1-50-...	G2			154	171	124		16.5		68

Ordering data – Angle seat valve VZXF

	Process valve connection	Flow rate Kv [m³/h]	Medium pressure [bar]	Corrosion resistance CRC ¹⁾	Product weight [g]	Part No.	Type
	G½	3.5	0 ... 16	1	1200	1002500	VZXF-L-M22C-M-A-G12-120-H3B1-50-16
		3.7				1002501	VZXF-L-M22C-M-B-G12-120-H3B1-50-16
	G¾	5.2	0 ... 16		1300	1002503	VZXF-L-M22C-M-B-G34-160-H3B1-50-16
		6.7				1002502	VZXF-L-M22C-M-A-G34-160-H3B1-50-16
	G1	9.6	0 ... 10		1500	1002505	VZXF-L-M22C-M-B-G1-230-H3B1-50-10
		10.8				1002504	VZXF-L-M22C-M-A-G1-230-H3B1-50-16
	G1¼	6	0 ... 7		1900	1002507	VZXF-L-M22C-M-B-G114-290-H3B1-50-7
		19	0 ... 10			1002506	VZXF-L-M22C-M-A-G114-290-H3B1-50-10
	G1½	16.5	0 ... 6		2300	1002509	VZXF-L-M22C-M-B-G112-350-H3B1-50-6
		23				1002508	VZXF-L-M22C-M-A-G112-350-H3B1-50-8
	G2	23	0 ... 3		2800	1002511	VZXF-L-M22C-M-B-G2-430-H3B1-50-3
		28	0 ... 4			1002510	VZXF-L-M22C-M-A-G2-430-H3B1-50-4

1) Corrosion resistance class CRC 1 to Festo standard FN 940070

Low corrosion stress. For dry indoor applications or transport and storage protection. Also applies to parts behind covers, in the non-visible interior area, and parts which are covered in the application (e.g. drive trunnions).

Angle seat valve VZXF

Technical data – Gunmetal (red brass), temperature of medium –40 ... +200 °C

Function

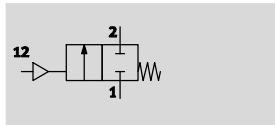

 Flow rate Kv
3.5 ... 40 m³/h

 G $\frac{1}{2}$... G2



General technical data			
Process valve connection	G $\frac{1}{2}$	G $\frac{3}{4}$	G1
Pneumatic connection	G $\frac{1}{8}$		
Nominal size DN	15	20	25
Nominal width [mm]	12	16	23
Valve function	2/2-way, closed, monostable		
Design	Poppet valve with spring return		
Type of mounting	In-line installation		
Mounting position	Any		
Direction of flow	Non-reversible		
Exhaust function	No flow control		
Sealing principle	Soft		
Reset method	Mechanical spring		
Type of actuation	Pneumatic		
Type of pilot control	Externally actuated		

Process valve connection	G1 $\frac{1}{4}$	G1 $\frac{1}{2}$	G2
Pneumatic connection	G $\frac{1}{8}$		
Nominal size DN	32	40	50
Nominal width [mm]	29	35	43
Valve function	2/2-way, closed, monostable		
Design	Poppet valve with spring return		
Type of mounting	In-line installation		
Mounting position	Any		
Direction of flow	Non-reversible		
Exhaust function	No flow control		
Sealing principle	Soft		
Reset method	Mechanical spring		
Type of actuation	Pneumatic		
Type of pilot control	Externally actuated		

Angle seat valve VZXF

Technical data – Gunmetal (red brass), temperature of medium –40 ... +200 °C

Operating and environmental conditions						
Process valve connection	G1/2		G3/4		G1	
Variant	...-M-A-...	...-M-B-...	...-M-A-...	...-M-B-...	...-M-A-...	...-M-B-...
Nominal pressure of process valve PN	16					
Operating pressure [bar]	6 ... 10					
Operating medium	Compressed air to ISO 8573-1:2010 [7:4:4]					
Medium	Steam					
	Inert gases					
	Filtered compressed air, degree of filtration 200 µm					
	–	Mineral oil-based hydraulic oil	–	Mineral oil-based hydraulic oil	–	Mineral oil-based hydraulic oil
	–	Mineral oil	–	Mineral oil	–	Mineral oil
–	Neutral fluids	–	Neutral fluids	–	Neutral fluids	
–	Water	–	Water	–	Water	
Max. viscosity [mm ² /s]	600					
Ambient temperature [°C]	–10 ... +60					
Temperature of medium [°C]	–40 ... +200					
CE marking (see declaration of conformity)	–					

Process valve connection	G1¼		G1½		G2	
Variant	...-M-A-...	...-M-B-...	...-M-A-...	...-M-B-...	...-M-A-...	...-M-B-...
Nominal pressure of process valve PN	16					
Operating pressure [bar]	6 ... 10					
Operating medium	Compressed air to ISO 8573-1:2010 [7:4:4]					
Medium	Steam					
	Inert gases					
	Filtered compressed air, degree of filtration 200 µm					
	–	Mineral oil-based hydraulic oil	–	Mineral oil-based hydraulic oil	–	Mineral oil-based hydraulic oil
	–	Mineral oil	–	Mineral oil	–	Mineral oil
–	Neutral fluids	–	Neutral fluids	–	Neutral fluids	
–	Water	–	Water	–	Water	
Max. viscosity [mm ² /s]	600					
Ambient temperature [°C]	–10 ... +60					
Temperature of medium [°C]	–40 ... +200					
CE marking (see declaration of conformity)	To EU Pressure Equipment Directive					

Materials			
Angle seat valves	...-H3ALT-...	...-H3B1T-...	Material number
1 Housing	Gunmetal (red brass)		CC499K
2 Actuator head	Aluminium	Brass	–
3 Stem seal	PTFE		–
Seat seal	PTFE		–
– Note on materials	Contains paint-wetting impairment substances, RoHS compliant		

Angle seat valve VZXF

Technical data – Gunmetal (red brass), temperature of medium –40 ... +200 °C

Dimensions

Download CAD data → www.festo.com

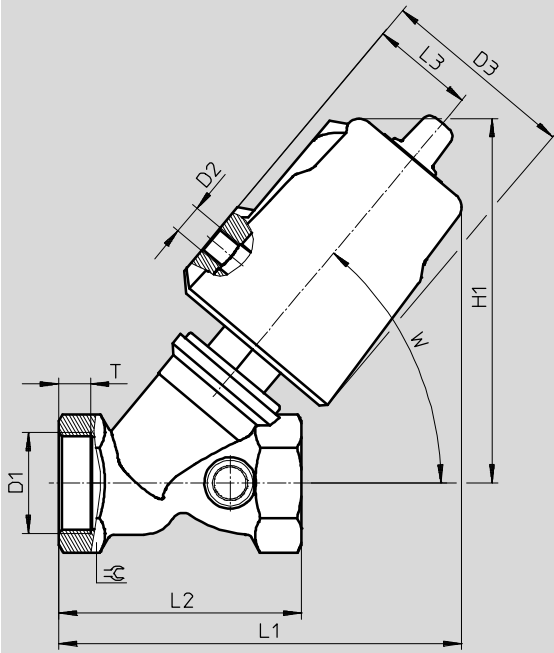

	D1	D2	D3 Ø	H1	L1	L2	L3	T	W	☉
VZXF-L-...-G12-...-H3B1T-50-...	G1/2	G1/8	62	130	135.5	66	34	13	50°	27
VZXF-L-...-G34-...-H3B1T-50-...	G3/4			130	140	75		14.5		32
VZXF-L-...-G1-...-H3B1T-50-...	G1			133	143	80		10.5		41
VZXF-L-...-G114-...-H3B1T-50-...	G1 1/4			148	160	97		12.5		50
VZXF-L-...-G114-...-H3ALT-80-...	G1 1/4		94	180	190	97	49	12.5		50
VZXF-L-...-G112-...-H3B1T-50-...	G1 1/2		62	152.5	167	107	34	14.5		55
VZXF-L-...-G112-...-H3ALT-80-...	G1 1/2		94	186	197	107	49	14.5		55
VZXF-L-...-G2-...-H3B1T-50-...	G2		62	162	178	124	34	16.5		67
VZXF-L-...-G2-...-H3ALT-80-...	G2		94	196	207.5	124	49	16.5		67

Angle seat valve VZXF

Technical data – Gunmetal (red brass), temperature of medium –40 ... +200 °C

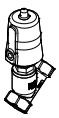
Ordering data – Angle seat valve VZXF							
	Process valve connection	Flow rate Kv [m³/h]	Medium pressure [bar]	Corrosion resistance CRC ¹⁾	Product weight [g]	Part No.	Type
	G1/2	3.5	0 ... 16	1	1200	3535619	VZXF-L-M22C-M-A-G12-120-M1-H3B1T-50-16
		3.7				3535620	VZXF-L-M22C-M-B-G12-120-M1-H3B1T-50-16
	G3/4	5.2	0 ... 16	1	1300	3535644	VZXF-L-M22C-M-B-G34-160-M1-H3B1T-50-16
		6.7				3535643	VZXF-L-M22C-M-A-G34-160-M1-H3B1T-50-16
	G1	9.6	0 ... 10	1	1500	3535665	VZXF-L-M22C-M-B-G1-230-M1-H3B1T-50-10
		10.8	0 ... 16			3535664	VZXF-L-M22C-M-A-G1-230-M1-H3B1T-50-16
		14.5	0 ... 16	–	2000	3540768	VZXF-L-M22C-M-B-G1-230-M1-H3ALT-80-16
	G1 1/4	6	0 ... 7	1	1900	3535689	VZXF-L-M22C-M-B-G114-290-M1-H3B1T-50-7
		19	0 ... 10			3535684	VZXF-L-M22C-M-A-G114-290-M1-H3B1T-50-10
		19	0 ... 12	–	2300	3535712	VZXF-L-M22C-M-B-G114-290-M1-H3ALT-80-12
		21.5	0 ... 16	3535711		VZXF-L-M22C-M-A-G114-290-M1-H3ALT-80-16	
	G1 1/2	16.5	0 ... 6	1	2300	3535721	VZXF-L-M22C-M-B-G112-350-M1-H3B1T-50-6
		23	0 ... 7			3535720	VZXF-L-M22C-M-A-G112-350-M1-H3B1T-50-7
		29.5	0 ... 8	–	2600	3535825	VZXF-L-M22C-M-B-G112-350-M1-H3ALT-80-8
		30.5	0 ... 16	3535824		VZXF-L-M22C-M-A-G112-350-M1-H3ALT-80-16	
	G2	23	0 ... 3	1	2800	3535838	VZXF-L-M22C-M-B-G2-430-M1-H3B1T-50-3
		28	0 ... 4			3535837	VZXF-L-M22C-M-A-G2-430-M1-H3B1T-50-4
		30	0 ... 5	–	2900	3536436	VZXF-L-M22C-M-B-G2-430-M1-H3ALT-80-5
		40	0 ... 16	3536435		VZXF-L-M22C-M-A-G2-430-M1-H3ALT-80-16	

1) Corrosion resistance class CRC 1 to Festo standard FN 940070
 Low corrosion stress. For dry indoor applications or transport and storage protection. Also applies to parts behind covers, in the non-visible interior area, and parts which are covered in the application (e.g. drive trunnions).

Angle seat valve VZXF

Technical data – Gunmetal (red brass), vacuum version

Function

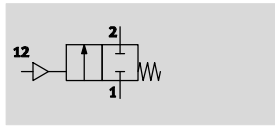

 Flow rate Kv
3.5 ... 40 m³/h

 G $\frac{1}{2}$... G2



General technical data			
Process valve connection	G $\frac{1}{2}$	G $\frac{3}{4}$	G1
Pneumatic connection	G $\frac{1}{8}$		
Nominal size DN	15	20	25
Nominal width [mm]	12	16	23
Valve function	2/2-way, closed, monostable		
Design	Poppet valve with spring return		
Type of mounting	In-line installation		
Mounting position	Any		
Direction of flow	Non-reversible		
Exhaust function	No flow control		
Sealing principle	Soft		
Reset method	Mechanical spring		
Type of actuation	Pneumatic		
Type of pilot control	Externally actuated		

Process valve connection	G1 $\frac{1}{4}$	G1 $\frac{1}{2}$	G2
Pneumatic connection	G $\frac{1}{8}$		
Nominal size DN	32	40	50
Nominal width [mm]	29	35	43
Valve function	2/2-way, closed, monostable		
Design	Poppet valve with spring return		
Type of mounting	In-line installation		
Mounting position	Any		
Direction of flow	Non-reversible		
Exhaust function	No flow control		
Sealing principle	Soft		
Reset method	Mechanical spring		
Type of actuation	Pneumatic		
Type of pilot control	Externally actuated		

Angle seat valve VZXF

Technical data – Gunmetal (red brass), vacuum version

Operating and environmental conditions						
Process valve connection	G1/2		G3/4		G1	
Variant	...-M-A-...	...-M-B-...	...-M-A-...	...-M-B-...	...-M-A-...	...-M-B-...
Nominal pressure of process valve PN	16					
Operating pressure [bar]	6 ... 10					
Operating medium	Compressed air to ISO 8573-1:2010 [7:4:4]					
Medium	Steam					
	Inert gases					
	Filtered compressed air, degree of filtration 200 µm					
	–	Mineral oil-based hydraulic oil	–	Mineral oil-based hydraulic oil	–	Mineral oil-based hydraulic oil
	–	Mineral oil	–	Mineral oil	–	Mineral oil
–	Neutral fluids	–	Neutral fluids	–	Neutral fluids	
–	Water	–	Water	–	Water	
Max. viscosity [mm ² /s]	600					
Ambient temperature [°C]	–10 ... +60					
Temperature of medium [°C]	–10 ... +80					
CE marking (see declaration of conformity)	–					

Process valve connection	G1 1/4		G1 1/2		G2	
Variant	...-M-A-...	...-M-B-...	...-M-A-...	...-M-B-...	...-M-A-...	...-M-B-...
Nominal pressure of process valve PN	16					
Operating pressure [bar]	6 ... 10					
Operating medium	Compressed air to ISO 8573-1:2010 [7:4:4]					
Medium	Steam					
	Inert gases					
	Filtered compressed air, degree of filtration 200 µm					
	–	Mineral oil-based hydraulic oil	–	Mineral oil-based hydraulic oil	–	Mineral oil-based hydraulic oil
	–	Mineral oil	–	Mineral oil	–	Mineral oil
–	Neutral fluids	–	Neutral fluids	–	Neutral fluids	
–	Water	–	Water	–	Water	
Max. viscosity [mm ² /s]	600					
Ambient temperature [°C]	–10 ... +60					
Temperature of medium [°C]	–10 ... +80					
CE marking (see declaration of conformity)	To EU Pressure Equipment Directive					

Materials			
Angle seat valves	...-H3ALV-...	...-H3B1V-...	Material number
1 Housing	Gunmetal (red brass)		CC499K
2 Actuator head	Aluminium	Brass	–
3 Stem seal	FPM		–
Seat seal	FPM		–
– Note on materials	Contains paint-wetting impairment substances, RoHS compliant		

Angle seat valve VZXF

Technical data – Gunmetal (red brass), vacuum version

Dimensions

Download CAD data → www.festo.com

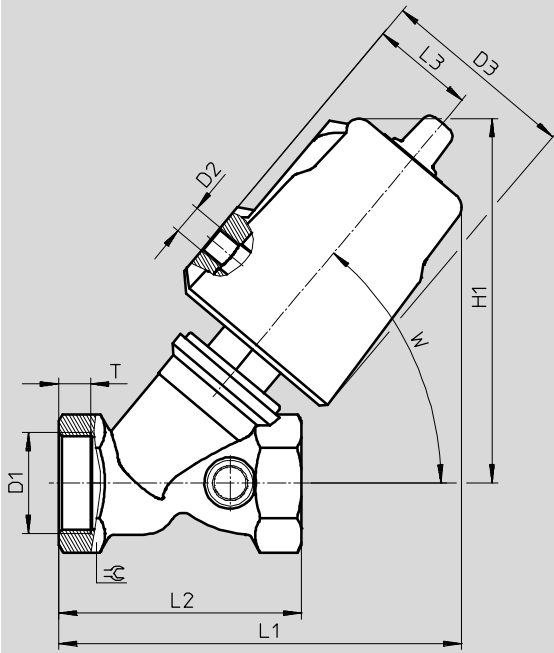

	D1	D2	D3 Ø	H1	L1	L2	L3	T	W	∠
VZXF-L-...-G12-...-H3B1V-50-...	G1/2	G1/8	62	113.5	123	66	34	13	50°	27
VZXF-L-...-G34-...-H3B1V-50-...	G3/4			118	130	75	34	14.5		32
VZXF-L-...-G1-...-H3B1V-50-...	G1			121	133	80	34	10.5		41
VZXF-L-...-G1-...-H3ALV-80-...	G1		94	168	174.5	80	49	10.5		41
VZXF-L-...-G114-...-H3B1V-50-...	G1 1/4		62	138.5	153.5	97	34	12.5		50
VZXF-L-...-G114-...-H3ALV-80-...	G1 1/4		94	174.5	185	97	49	12.5		50
VZXF-L-...-G112-...-H3B1V-50-...	G1 1/2		62	146	160	107	34	14.5		55
VZXF-L-...-G112-...-H3ALV-80-...	G1 1/2		94	180.5	192	107	49	14.5		55
VZXF-L-...-G2-...-H3ALV-80-...	G2		94	190	202.5	124	49	16.5		68

Ordering data – Angle seat valve VZXF

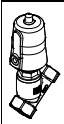
	Process valve connection	Flow rate Kv [m³/h]	Medium pressure [bar]	Corrosion resistance CRC ¹⁾	Product weight [g]	Part No.	Type
	G1/2	3.5	-0.9	1	1200	3538869	VZXF-L-M22C-M-A-G12-120-H3B1V-50-V
	G3/4	6.7		1	1300	3539178	VZXF-L-M22C-M-A-G34-160-H3B1V-50-V
	G1	10.8		1	1500	3539247	VZXF-L-M22C-M-A-G1-230-H3B1V-50-V
		12		-	2000	3536819	VZXF-L-M22C-M-A-G1-230-H3ALV-80-V
	G1 1/4	19		1	1900	3539352	VZXF-L-M22C-M-A-G114-290-H3B1V-50-V
		21.5		-	2300	3536830	VZXF-L-M22C-M-A-G114-290-H3ALV-80-V
	G1 1/2	23		1	2300	3539367	VZXF-L-M22C-M-A-G112-350-H3B1V-50-V
		30.5		-	2600	3536850	VZXF-L-M22C-M-A-G112-350-H3ALV-80-V
	G2	40		-	2900	3540796	VZXF-L-M22C-M-A-G2-430-H3ALV-80-V

1) Corrosion resistance class CRC 1 to Festo standard FN 940070

Low corrosion stress. For dry indoor applications or transport and storage protection. Also applies to parts behind covers, in the non-visible interior area, and parts which are covered in the application (e.g. drive trunnions).

Angle seat valve VZXF

Technical data – Gunmetal (red brass), PWIS-free

Function

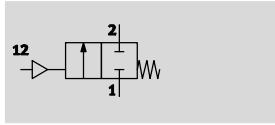

 Flow rate Kv
3.7 ... 16.5 m³/h

 G $\frac{1}{2}$... G1 $\frac{1}{2}$



General technical data				
Process valve connection	G $\frac{1}{2}$	G $\frac{3}{4}$	G1	G1 $\frac{1}{2}$
Pneumatic connection	G $\frac{1}{8}$			
Nominal size DN	15	20	25	40
Nominal width [mm]	12	16	23	35
Valve function	2/2-way, closed, monostable			
Design	Poppet valve with spring return			
Type of mounting	In-line installation			
Mounting position	Any			
Direction of flow	Non-reversible			
Exhaust function	No flow control			
Sealing principle	Soft			
Reset method	Mechanical spring			
Type of actuation	Pneumatic			
Type of pilot control	Externally actuated			

Operating and environmental conditions				
Process valve connection	G $\frac{1}{2}$	G $\frac{3}{4}$	G1	G1 $\frac{1}{2}$
Nominal pressure of process valve PN	16			
Operating pressure [bar]	6 ... 10			
Operating medium	Compressed air to ISO 8573-1:2010 [7:4:4]			
Medium	Inert gases			
	Filtered compressed air, degree of filtration 200 μ m			
	Mineral oil-based hydraulic oil			
	Mineral oil			
	Neutral fluids			
	Water			
Max. viscosity [mm ² /s]	600			
Ambient temperature [°C]	-10 ... +60			
Temperature of medium [°C]	-10 ... +80			
CE marking (see declaration of conformity)	-			

Materials		
Angle seat valves		Material number
1 Housing	Gunmetal (red brass)	CC499K
2 Actuator head	Brass	-
3 Stem seal	FPM	-
Seat seal	FPM	-
- Note on materials	RoHS compliant	

Angle seat valve VZXF

Technical data – Gunmetal (red brass), PWIS-free

Dimensions

Download CAD data → www.festo.com

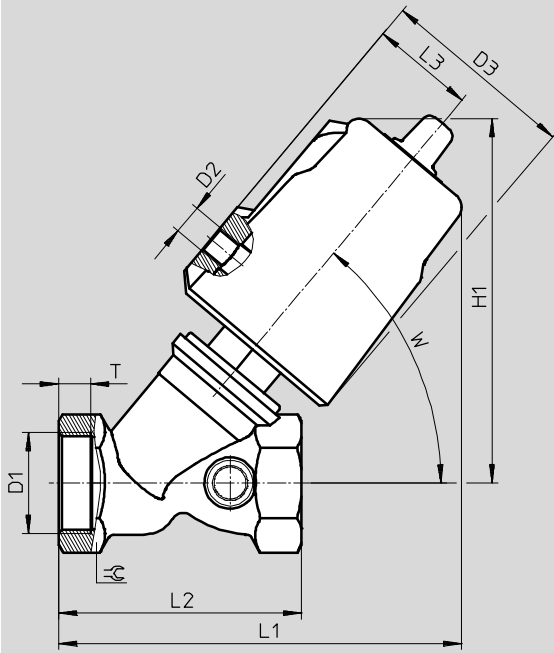

	D1	D2	D3 Ø	H1	L1	L2	L3	T	W	☞
VZXF-L-...-G12-...-H3B1V-50-...	G1/2	G1/8	62	113.5	123	66	34	13	50°	27
VZXF-L-...-G34-...-H3B1V-50-...	G3/4			118	130	75	34	14.5		32
VZXF-L-...-G1-...-H3B1V-50-...	G1			121	133	80	34	10.5		41
VZXF-L-...-G112-...-H3B1V-50-...	G1 1/2		62	146	160	107	34	14.5		55

Ordering data – Angle seat valve VZXF

	Process valve connection	Flow rate Kv [m³/h]	Medium pressure [bar]	Corrosion resistance CRC ¹⁾	Product weight [g]	Part No.	Type
	G1/2	3.7	0 ... 16	1	1200	3539036	VZXF-L-M22C-M-B-G12-120-H3B1V-50-16-C
	G3/4	5.2	0 ... 16		1300	3539179	VZXF-L-M22C-M-B-G34-160-H3B1V-50-16-C
	G1	9.6	0 ... 10		1500	3539248	VZXF-L-M22C-M-B-G1-230-H3B1V-50-10-C
	G1 1/2	16.5	0 ... 6		2300	3539368	VZXF-L-M22C-M-B-G112-350-H3B1V-50-6-C

1) Corrosion resistance class CRC 1 to Festo standard FN 940070
Low corrosion stress. For dry indoor applications or transport and storage protection. Also applies to parts behind covers, in the non-visible interior area, and parts which are covered in the application (e.g. drive trunnions).

Angle seat valve VZXF

Technical data – Gunmetal (red brass) with EX certification

Function

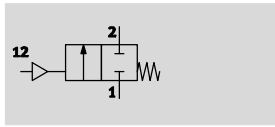

 Flow rate Kv
3.5 ... 28 m³/h

 G $\frac{1}{2}$... G2



General technical data			
Process valve connection	G $\frac{1}{2}$	G $\frac{3}{4}$	G1
Pneumatic connection	G $\frac{1}{8}$		
Nominal size DN	15	20	25
Nominal width [mm]	13	16	23
Valve function	2/2-way, closed, monostable		
Design	Poppet valve with spring return		
Type of mounting	In-line installation		
Mounting position	Any		
Direction of flow	Non-reversible		
Exhaust function	No flow control		
Sealing principle	Soft		
Reset method	Mechanical spring		
Type of actuation	Pneumatic		
Type of pilot control	Externally actuated		

Process valve connection	G1 $\frac{1}{4}$	G1 $\frac{1}{2}$	G2
Pneumatic connection	G $\frac{1}{8}$		
Nominal size DN	32	40	50
Nominal width [mm]	29	35	45
Valve function	2/2-way, closed, monostable		
Design	Poppet valve with spring return		
Type of mounting	In-line installation		
Mounting position	Any		
Direction of flow	Non-reversible		
Exhaust function	No flow control		
Sealing principle	Soft		
Reset method	Mechanical spring		
Type of actuation	Pneumatic		
Type of pilot control	Externally actuated		

Angle seat valve VZXF

Technical data – Gunmetal (red brass) with EX certification

Operating and environmental conditions						
Process valve connection Variant	G1/2 ...-M-A-... ...-M-B-...		G3/4 ...-M-A-... ...-M-B-...		G1 ...-M-A-... ...-M-B-...	
Nominal pressure of process valve PN	16					
Operating pressure [bar]	6 ... 10					
Operating medium	Compressed air to ISO 8573-1:2010 [7:4:4]					
Medium	Inert gases					
	Filtered compressed air, degree of filtration 200 µm					
	–	Mineral oil-based hydraulic oil	–	Mineral oil-based hydraulic oil	–	Mineral oil-based hydraulic oil
	–	Mineral oil	–	Mineral oil	–	Mineral oil
	–	Neutral fluids	–	Neutral fluids	–	Neutral fluids
–	Water	–	Water	–	Water	
Max. viscosity [mm ² /s]	600					
Ambient temperature [°C]	–10 ... +60					
Temperature of medium [°C]	–10 ... +80					
ATEX category for gas	II 2G					
Type of ignition protection for gas	c TX X					
ATEX category for dust	II 2D					
Type of ignition protection for dust	c TX X					
Explosion-proof temperature	–10 °C ≤ Ta ≤ +60 °C					
CE marking (see declaration of conformity)	As per EU Explosion Protection Directive (ATEX)					

Process valve connection Variant	G1 1/4 ...-M-A-... ...-M-B-...		G1 1/2 ...-M-A-... ...-M-B-...		G2 ...-M-A-... ...-M-B-...	
Nominal pressure of process valve PN	16					
Operating pressure [bar]	6 ... 10					
Operating medium	Compressed air to ISO 8573-1:2010 [7:4:4]					
Medium	Inert gases					
	Filtered compressed air, degree of filtration 200 µm					
	–	Mineral oil-based hydraulic oil	–	Mineral oil-based hydraulic oil	–	Mineral oil-based hydraulic oil
	–	Mineral oil	–	Mineral oil	–	Mineral oil
	–	Neutral fluids	–	Neutral fluids	–	Neutral fluids
–	Water	–	Water	–	Water	
Max. viscosity [mm ² /s]	600					
Ambient temperature [°C]	–10 ... +60					
Temperature of medium [°C]	–10 ... +80					
ATEX category for gas	II 2G					
Type of ignition protection for gas	c TX X					
ATEX category for dust	II 2D					
Type of ignition protection for dust	c TX X					
Explosion-proof temperature	–10 °C ≤ Ta ≤ +60 °C					
CE marking (see declaration of conformity)	To EU Pressure Equipment Directive As per EU Explosion Protection Directive (ATEX)					

Angle seat valve VZXF

Technical data – Gunmetal (red brass) with EX certification

Materials		
Angle seat valves		Material number
1 Housing	Gunmetal (red brass)	CC499K
2 Actuator head	Brass	-
3 Stem seal	NBR	-
Seat seal	PTFE	
- Note on materials	Contains paint-wetting impairment substances, RoHS compliant	

Dimensions Download CAD data → www.festo.com

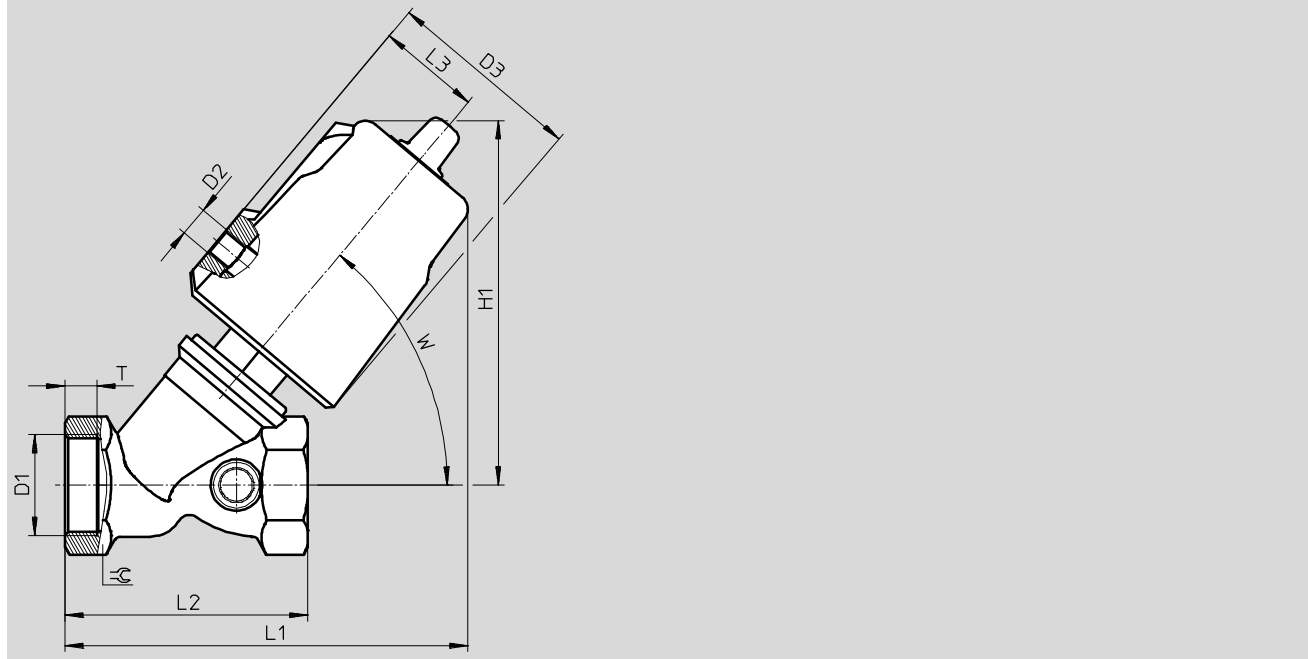

	D1	D2	D3 Ø	H1	L1	L2	L3	T	W	
VZXF-L-...-G12-...-H3B1-50-...	G½	G½	62	112	123	66	34	8	50°	27
VZXF-L-...-G34-...-H3B1-50-...	G¾			117	130	75	34	9		33
VZXF-L-...-G1-...-H3B1-50-...	G1			121	133	80	34	10.5		41
VZXF-L-...-G114-...-H3B1-50-...	G1¼			139	154	97	34	12.5		50
VZXF-L-...-G112-...-H3B1-50-...	G1½			145	161	107	34	14.5		56
VZXF-L-...-G2-...-H3B1-50-...	G2			154	171	124	34	16.5		68

Angle seat valve VZXF

Technical data – Gunmetal (red brass) with EX certification

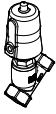
Ordering data – Angle seat valve VZXF						
	Process valve connection	Flow rate Kv [m ³ /h]	Medium pressure [bar]	Corrosion resistance CRC ¹⁾	Product weight [g]	Part No. Type
	G1/2	3.5	0 ... 16	1	1200	3539021 VZXF-L-M22C-M-A-G12-120-H3B1-50-16-EX4
		3.7				3539037 VZXF-L-M22C-M-B-G12-120-H3B1-50-16-EX4
	G3/4	5.2	0 ... 16		1300	3539181 VZXF-L-M22C-M-B-G34-160-H3B1-50-16-EX4
		6.7				3539180 VZXF-L-M22C-M-A-G34-160-H3B1-50-16-EX4
	G1	9.6	0 ... 10		1500	3539250 VZXF-L-M22C-M-B-G1-230-H3B1-50-10-EX4
		10.8	0 ... 16			3539249 VZXF-L-M22C-M-A-G1-230-H3B1-50-16-EX4
	G1 1/4	6	0 ... 7		1900	3539354 VZXF-L-M22C-M-B-G114-290-H3B1-50-7-EX4
		19	0 ... 10			3539353 VZXF-L-M22C-M-A-G114-290-H3B1-50-10-EX4
	G1 1/2	16.5	0 ... 6		2300	3539370 VZXF-L-M22C-M-B-G112-350-H3B1-50-6-EX4
		23	0 ... 7			3539369 VZXF-L-M22C-M-A-G112-350-H3B1-50-7-EX4
	G2	23	0 ... 3		2800	3540293 VZXF-L-M22C-M-B-G2-430-H3B1-50-3-EX4
		28	0 ... 4			3540292 VZXF-L-M22C-M-A-G2-430-H3B1-50-4-EX4

1) Corrosion resistance class CRC 1 to Festo standard FN 940070

Low corrosion stress. For dry indoor applications or transport and storage protection. Also applies to parts behind covers, in the non-visible interior area, and parts which are covered in the application (e.g. drive trunnions).

Angle seat valve VZXF

FESTO

Technical data – Stainless steel casting, temperature of medium –40 ... +200 °C

Function

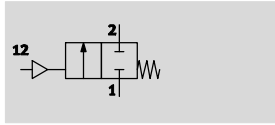

-  - Flow rate Kv
3.3 ... 43 m³/h

-  - Connecting thread
G $\frac{1}{2}$... G2



General technical data			
Process valve connection	G $\frac{1}{2}$	G $\frac{3}{4}$	G1
Auxiliary pilot air port	G $\frac{1}{8}$		
Nominal size DN	15	20	25
Nominal width [mm]	13	18	24
Valve function	2/2-way, closed, monostable		
Design	Poppet valve with spring return		
Type of mounting	In-line installation		
Mounting position	Any		
Direction of flow	Non-reversible		
Exhaust function	No flow control		
Sealing principle	Soft		
Reset method	Mechanical spring		
Type of actuation	Pneumatic		
Type of pilot control	With external control		
Operating medium	Compressed air to ISO 8573-1:2010 [7:4:4]		

Process valve connection	G1 $\frac{1}{4}$	G1 $\frac{1}{2}$	G2
Auxiliary pilot air port	G $\frac{1}{8}$		
Nominal size DN	32	40	50
Nominal width [mm]	31	35	45
Valve function	2/2-way, closed, monostable		
Design	Poppet valve with spring return		
Type of mounting	In-line installation		
Mounting position	Any		
Direction of flow	Non-reversible		
Exhaust function	No flow control		
Sealing principle	Soft		
Reset method	Mechanical spring		
Type of actuation	Pneumatic		
Type of pilot control	With external control		
Operating medium	Compressed air to ISO 8573-1:2010 [7:4:4]		

Angle seat valve VZXF

FESTO

Technical data – Stainless steel casting, temperature of medium –40 ... +200 °C

Operating and environmental conditions			
Process valve connection	G1/2	G3/4	G1
Nominal pressure of process valve PN	40		
Medium	Filtered compressed air, grade of filtration 200 µm		
	Mineral oil-based hydraulic oil		
	Inert gases		
	Mineral oil		
	Neutral fluids		
	Water		
	Steam		
Max. viscosity	[mm ² /s]	600	
Ambient temperature	[°C]	–10 ... 60	
Temperature of medium	[°C]	–40 ... 200	
CE marking (see declaration of conformity)	–		

Operating and environmental conditions			
Process valve connection	G1¼	G1½	G2
Nominal pressure of process valve PN	40		
Medium	Filtered compressed air, grade of filtration 200 µm		
	Mineral oil-based hydraulic oil		
	Inert gases		
	Mineral oil		
	Neutral fluids		
	Water		
	Steam		
Max. viscosity	[mm ² /s]	600	
Ambient temperature	[°C]	–10 ... 60	
Temperature of medium	[°C]	–40 ... 200	
CE marking (see declaration of conformity)	To EU Pressure Equipment Directive		

Materials		
Angle seat valves		Material number
1 Housing	Stainless steel casting	1.4408
2 Actuator head	Stainless steel	–
3 Stem seal	PTFE	–
	Seat seal	PTFE
– Note on materials	Contains paint-wetting impairment substances, RoHS compliant	–

Angle seat valve VZXF

Technical data – Stainless steel casting, temperature of medium –40 ... +200 °C

Dimensions

Download CAD data → www.festo.com

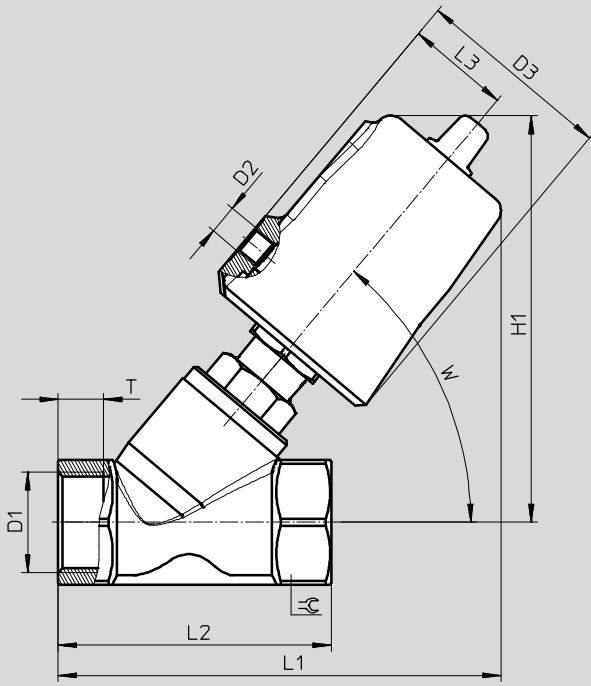

	D1	D2	D3 ∅	H1	L1	L2	L3	T	W	☉
VZXF-L-...-G12-...-V4V4T-50-...	G1/2	G1/8	62	129	135	65	34	12	50°	27
VZXF-L-...-G34-...-V4V4T-50-...	G3/4		62	130	138	75	34	13		32
VZXF-L-...-G1-...-V4V4T-50-...	G1		62	135	146	90	34	15		42
VZXF-L-...-G1-...-V4V4T-80-...	G1		94	177	184		48			
VZXF-L-...-G114-...-V4V4T-50-...	G1 1/4		62	151	155	110	34	17		50
VZXF-L-...-G114-...-V4V4T-80-...	G1 1/4		94	183	194		48			
VZXF-L-...-G112-...-V4V4T-50-...	G1 1/2		62	155	174	120	34	19		55
VZXF-L-...-G112-...-V4V4T-80-...	G1 1/2		94	187	202		48			
VZXF-L-...-G2-...-V4V4T-50-...	G2		62	167	193	150	34	21		70
VZXF-L-...-G2-...-V4V4T-80-...	G2		94	199	222		48			

Angle seat valve VZXF

Technical data – Stainless steel casting, temperature of medium –40 ... +200 °C

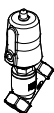
Ordering data – Angle seat valve VZXF								
	Process valve connection	Flow rate Kv [m³/h]	Medium pressure [bar]	Corrosion resistance CRC ¹⁾	Product weight [g]	Part No.	Type	
	G½	3.3	0 ... 40	3	1300	1002513	VZXF-L-M22C-M-B-G12-130-M1-V4V4T-50-40	
		3.8	0 ... 25			1002512	VZXF-L-M22C-M-A-G12-130-M1-V4V4T-50-25	
	G¾	6.5	0 ... 20		1400	1002515	VZXF-L-M22C-M-B-G34-180-M1-V4V4T-50-20	
		7.5	0 ... 20			1002514	VZXF-L-M22C-M-A-G34-180-M1-V4V4T-50-20	
	G1	11	0 ... 10		1600	1002517	VZXF-L-M22C-M-B-G1-240-M1-V4V4T-50-10	
		12	0 ... 16			1002516	VZXF-L-M22C-M-A-G1-240-M1-V4V4T-50-16	
		12	0 ... 22			3600	1002526	VZXF-L-M22C-M-B-G1-240-M1-V4V4-T-80-22
		12.5	0 ... 40				1002525	VZXF-L-M22C-M-A-G1-240-M1-V4V4-T-80-40
	G1¼	10.7	0 ... 7		2200	1002519	VZXF-L-M22C-M-B-G114-310-M1-V4V4T-50-7	
		17.5	0 ... 10			3800	1002528	VZXF-L-M22C-M-B-G114-310-M1-V4V4T-80-10
		18.5	0 ... 9			2200	1002518	VZXF-L-M22C-M-A-G114-310-M1-V4V4T-50-9
		19	0 ... 25			3800	1002527	VZXF-L-M22C-M-A-G114-310-M1-V4V4T-80-25
	G1½	17.5	0 ... 6		2500	1002521	VZXF-L-M22C-M-B-G112-350-M1-V4V4T-50-6	
		25	0 ... 7			4300	1002520	VZXF-L-M22C-M-A-G112-350-M1-V4V4T-50-7
		28	0 ... 8				1002530	VZXF-L-M22C-M-B-G112-350-M1-V4V4T-80-8
		29	0 ... 20			1002529	VZXF-L-M22C-M-A-G112-350-M1-V4V4T-80-20	
	G2	19.5	0 ... 3		3500	1002523	VZXF-L-M22C-M-B-G2-450-M1-V4V4T-50-3	
		34.5	0 ... 4			1002522	VZXF-L-M22C-M-A-G2-450-M1-V4V4T-50-4	
		39	0 ... 5			5400	1002532	VZXF-L-M22C-M-B-G2-450-M1-V4V4T-80-5
		43	0 ... 12				1002531	VZXF-L-M22C-M-A-G2-450-M1-V4V4T-80-12

1) Corrosion resistance class CRC 3 to Festo standard FN 940070
 High corrosion stress. Outdoor exposure under moderate corrosive conditions. External visible parts with primarily functional requirements for the surface and which are in direct contact with a normal industrial environment.

Angle seat valve VZXF

Technical data – Stainless steel casting with nickel-plated actuator head

Function

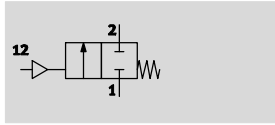

 Flow rate Kv
3.5 ... 40 m³/h

 G $\frac{1}{2}$... G2



General technical data			
Process valve connection	G $\frac{1}{2}$	G $\frac{3}{4}$	G1
Pneumatic connection	G $\frac{1}{8}$		
Nominal size DN	15	20	25
Nominal width [mm]	13	18	24
Valve function	2/2-way, closed, monostable		
Design	Poppet valve with spring return		
Type of mounting	In-line installation		
Mounting position	Any		
Direction of flow	Non-reversible		
Exhaust function	No flow control		
Sealing principle	Soft		
Reset method	Mechanical spring		
Type of actuation	Pneumatic		
Type of pilot control	Externally actuated		

Process valve connection	G1 $\frac{1}{4}$	G1 $\frac{1}{2}$	G2
Pneumatic connection	G $\frac{1}{8}$		
Nominal size DN	32	40	50
Nominal width [mm]	31	35	45
Valve function	2/2-way, closed, monostable		
Design	Poppet valve with spring return		
Type of mounting	In-line installation		
Mounting position	Any		
Direction of flow	Non-reversible		
Exhaust function	No flow control		
Sealing principle	Soft		
Reset method	Mechanical spring		
Type of actuation	Pneumatic		
Type of pilot control	Externally actuated		

Angle seat valve VZXF

Technical data – Stainless steel casting with nickel-plated actuator head

Operating and environmental conditions						
Process valve connection	G $\frac{1}{2}$		G $\frac{3}{4}$		G1	
Variant	...-M-A-...	...-M-B-...	...-M-A-...	...-M-B-...	...-M-A-...	...-M-B-...
Nominal pressure of process valve PN	40					
Operating pressure [bar]	6 ... 10					
Operating medium	Compressed air to ISO 8573-1:2010 [7:4:4]					
Medium	Steam					
	Inert gases					
	Filtered compressed air, degree of filtration 200 μ m					
	–	Mineral oil-based hydraulic oil	–	Mineral oil-based hydraulic oil	–	Mineral oil-based hydraulic oil
	–	Mineral oil	–	Mineral oil	–	Mineral oil
	–	Neutral fluids	–	Neutral fluids	–	Neutral fluids
–	Water	–	Water	–	Water	
Max. viscosity [mm ² /s]	600					
Ambient temperature [°C]	–10 ... +60					
Temperature of medium [°C]	–40 ... +200					
CE marking (see declaration of conformity)	–					

Process valve connection	G1 $\frac{1}{4}$		G1 $\frac{1}{2}$		G2	
Variant	...-M-A-...	...-M-B-...	...-M-A-...	...-M-B-...	...-M-A-...	...-M-B-...
Nominal pressure of process valve PN	40					
Operating pressure [bar]	6 ... 10					
Operating medium	Compressed air to ISO 8573-1:2010 [7:4:4]					
Medium	Steam					
	Inert gases					
	Filtered compressed air, degree of filtration 200 μ m					
	–	Mineral oil-based hydraulic oil	–	Mineral oil-based hydraulic oil	–	Mineral oil-based hydraulic oil
	–	Mineral oil	–	Mineral oil	–	Mineral oil
	–	Neutral fluids	–	Neutral fluids	–	Neutral fluids
–	Water	–	Water	–	Water	
Max. viscosity [mm ² /s]	600					
Ambient temperature [°C]	–10 ... +60					
Temperature of medium [°C]	–40 ... +200					
CE marking (see declaration of conformity)	To EU Pressure Equipment Directive					

Materials			
Angle seat valves	... -V4ANT- -V4B2T- ...	Material number
① Housing	Stainless steel casting		1.4408
② Actuator head	Nickel-plated aluminium	Nickel-plated brass	–
③ Stem seal	PTFE		–
Seat seal	PTFE		–
– Note on materials	Contains paint-wetting impairment substances, RoHS compliant		

Angle seat valve VZXF

Technical data – Stainless steel casting with nickel-plated actuator head

Dimensions

Download CAD data → www.festo.com

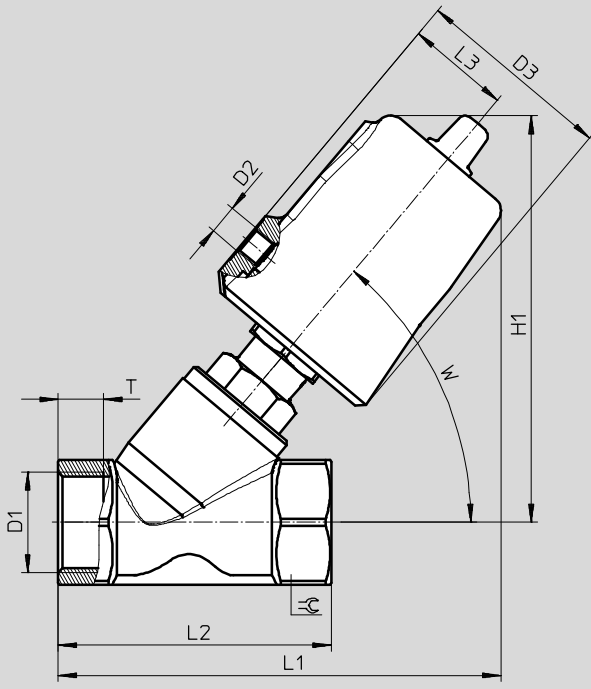

	D1	D2	D3 ∅	H1	L1	L2	L3	T	W	☉
VZXF-L-...-G12-...-V4B2T-50-...	G1/2	G1/8	62	128	133	65	34	12	50°	27
VZXF-L-...-G34-...-V4B2T-50-...	G3/4		62	128	136.5	75		13		32
VZXF-L-...-G1-...-V4B2T-50-...	G1		62	133	145	90		15		41
VZXF-L-...-G1-...-V4ANT-80-...			94	176.5	183	90	49	15		41
VZXF-L-...-G114-...-V4B2T-50-...	G1 1/4		62	150	163.5	110	34	17		50
VZXF-L-...-G114-...-V4ANT-80-...			94	183	193	110		17		50
VZXF-L-...-G112-...-V4B2T-50-...	G1 1/2		62	153	172	120		19		55
VZXF-L-...-G112-...-V4ANT-80-...			94	187	202	120		19		55
VZXF-L-...-G2-...-V4B2T-50-...	G2		62	167	193	150		21		70
VZXF-L-...-G2-...-V4ANT-80-...			94	199	221.5	150		49		21

Angle seat valve VZXF

Technical data – Stainless steel casting with nickel-plated actuator head

Ordering data – Angle seat valve VZXF							
	Process valve connection	Flow rate Kv [m ³ /h]	Medium pressure [bar]	Corrosion resistance CRC ¹⁾	Product weight [g]	Part No.	Type
	G1/2	3.3	0 ... 40	2	1300	3539720	VZXF-L-M22C-M-B-G12-130-M1-V4B2T-50-40
		3.8				3539719	VZXF-L-M22C-M-A-G12-130-M1-V4B2T-50-40
	G3/4	6.5	0 ... 20	2	1400	3538842	VZXF-L-M22C-M-B-G34-180-M1-V4B2T-50-20
		7.5				3539745	VZXF-L-M22C-M-A-G34-180-M1-V4B2T-50-20
	G1	11	0 ... 10	2	1600	3539783	VZXF-L-M22C-M-B-G1-240-M1-V4B2T-50-10
		12	0 ... 16	2	1600	3539782	VZXF-L-M22C-M-A-G1-240-M1-V4B2T-50-16
		12	0 ... 22	1	3600	3540198	VZXF-L-M22C-M-B-G1-240-M1-V4ANT-80-22
	G1 1/4	10.7	0 ... 7	2	2200	3539816	VZXF-L-M22C-M-B-G114-310-M1-V4B2T-50-7
		17.5	0 ... 10	1	3800	3540818	VZXF-L-M22C-M-B-G114-310-M1-V4ANT-80-10
		18.5	0 ... 9	2	2200	3539815	VZXF-L-M22C-M-A-G114-310-M1-V4B2T-50-9
		19	0 ... 25	1	3800	3540817	VZXF-L-M22C-M-A-G114-310-M1-V4ANT-80-25
	G1 1/2	17.5	0 ... 6	2	2500	3539927	VZXF-L-M22C-M-B-G112-350-M1-V4B2T-50-6
		25	0 ... 7	2	2500	3539926	VZXF-L-M22C-M-A-G112-350-M1-V4B2T-50-7
		28	0 ... 8	1	4300	3540250	VZXF-L-M22C-M-B-G112-350-M1-V4ANT-80-8
		29	0 ... 20	1	4300	3540248	VZXF-L-M22C-M-A-G112-350-M1-V4ANT-80-20
	G2	19.5	0 ... 3	2	3500	3540146	VZXF-L-M22C-M-B-G2-450-M1-V4B2T-50-3
		34.5	0 ... 4	2	3500	3540145	VZXF-L-M22C-M-A-G2-450-M1-V4B2T-50-4
		39	0 ... 5	1	5400	3540277	VZXF-L-M22C-M-B-G2-450-M1-V4ANT-80-5
		43	0 ... 12	1	5400	3540276	VZXF-L-M22C-M-A-G2-450-M1-V4ANT-80-12

1) Corrosion resistance class CRC 1 to Festo standard FN 940070

Low corrosion stress. For dry indoor applications or transport and storage protection. Also applies to parts behind covers, in the non-visible interior area, and parts which are covered in the application (e.g. drive trunnions).

2) Corrosion resistance class CRC 2 to Festo standard FN 940070

Moderate corrosion stress. Indoor applications in which condensation may occur. External visible parts with primarily decorative requirements for the surface and which are in direct contact with the ambient atmosphere typical for industrial applications.

Angle seat valve VZXF

Technical data – Stainless steel casting, vacuum version

Function

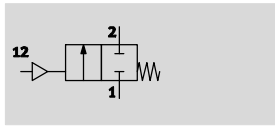

 Flow rate Kv
3.8 ... 43 m³/h

 G $\frac{1}{2}$... G2



General technical data			
Process valve connection	G $\frac{1}{2}$	G $\frac{3}{4}$	G1
Pneumatic connection	G $\frac{1}{8}$		
Nominal size DN	15	20	25
Nominal width [mm]	13	18	24
Valve function	2/2-way, closed, monostable		
Design	Poppet valve with spring return		
Type of mounting	In-line installation		
Mounting position	Any		
Direction of flow	Non-reversible		
Exhaust function	No flow control		
Sealing principle	Soft		
Reset method	Mechanical spring		
Type of actuation	Pneumatic		
Type of pilot control	Externally actuated		

Process valve connection	G1 $\frac{1}{4}$	G1 $\frac{1}{2}$	G2
Pneumatic connection	G $\frac{1}{8}$		
Nominal size DN	32	40	50
Nominal width [mm]	31	35	45
Valve function	2/2-way, closed, monostable		
Design	Poppet valve with spring return		
Type of mounting	In-line installation		
Mounting position	Any		
Direction of flow	Non-reversible		
Exhaust function	No flow control		
Sealing principle	Soft		
Reset method	Mechanical spring		
Type of actuation	Pneumatic		
Type of pilot control	Externally actuated		

Angle seat valve VZXF

Technical data – Stainless steel casting, vacuum version

Operating and environmental conditions						
Process valve connection	G $\frac{1}{2}$		G $\frac{3}{4}$		G1	
Variant	...-M-A-...	...-M-B-...	...-M-A-...	...-M-B-...	...-M-A-...	...-M-B-...
Nominal pressure of process valve PN	40					
Operating pressure [bar]	6 ... 10					
Operating medium	Compressed air to ISO 8573-1:2010 [7:4:4]					
Medium	Inert gases					
	Filtered compressed air, degree of filtration 200 μ m					
	–	Mineral oil-based hydraulic oil	–	Mineral oil-based hydraulic oil	–	Mineral oil-based hydraulic oil
	–	Mineral oil	–	Mineral oil	–	Mineral oil
	–	Neutral fluids	–	Neutral fluids	–	Neutral fluids
–	Water	–	Water	–	Water	
Max. viscosity [mm ² /s]	600					
Ambient temperature [°C]	–10 ... +60					
Temperature of medium [°C]	–10 ... +80					
CE marking (see declaration of conformity)	–					

Process valve connection	G1 $\frac{1}{4}$		G1 $\frac{1}{2}$		G2	
Variant	...-M-A-...	...-M-B-...	...-M-A-...	...-M-B-...	...-M-A-...	...-M-B-...
Nominal pressure of process valve PN	40					
Operating pressure [bar]	6 ... 10					
Operating medium	Compressed air to ISO 8573-1:2010 [7:4:4]					
Medium	Inert gases					
	Filtered compressed air, degree of filtration 200 μ m					
	–	Mineral oil-based hydraulic oil	–	Mineral oil-based hydraulic oil	–	Mineral oil-based hydraulic oil
	–	Mineral oil	–	Mineral oil	–	Mineral oil
	–	Neutral fluids	–	Neutral fluids	–	Neutral fluids
–	Water	–	Water	–	Water	
Max. viscosity [mm ² /s]	600					
Ambient temperature [°C]	–10 ... +60					
Temperature of medium [°C]	–10 ... +80					
CE marking (see declaration of conformity)	To EU Pressure Equipment Directive					

Angle seat valve VZXF

Technical data – Stainless steel casting, vacuum version

Materials			
Angle seat valves	...-V4ANV-...	...-V4B2V-...	Material number
1 Housing	Stainless steel casting		1.4408
2 Actuator head	Nickel-plated aluminium	Nickel-plated brass	–
3 Stem seal	FPM		–
Seat seal	FPM		–
– Note on materials	Contains paint-wetting impairment substances, RoHS compliant		

Dimensions Download CAD data → www.festo.com

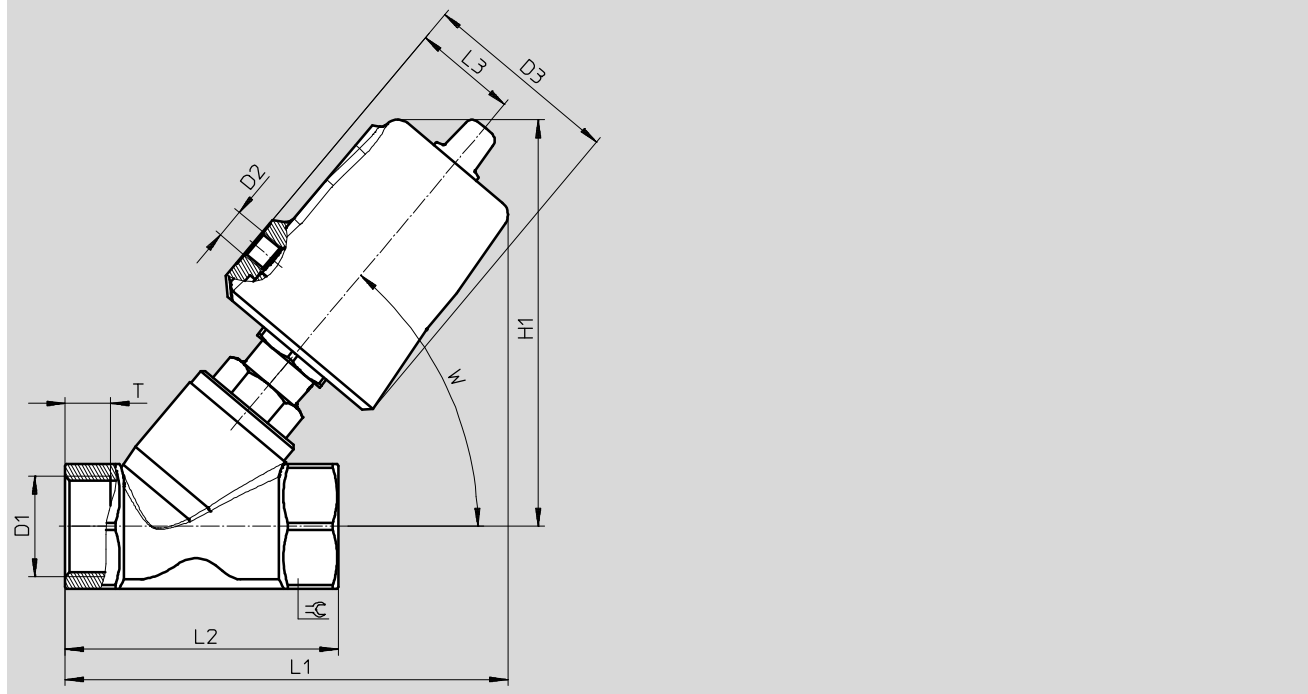

	D1	D2	D3 Ø	H1	L1	L2	L3	T	W	☉
VZXF-L-...-G12-...-V4B2V-50-...	G½	G⅜	62	112	119	65	34	12	50°	27
VZXF-L-...-G34-...-V4B2V-50-...	G¾		62	118	126.5	75	34	13		32
VZXF-L-...-G1-...-V4B2V-50-...	G1		62	121.5	135	90	34	15		41
VZXF-L-...-G1-...-V4ANV-80-...			94	169	176	90	49	15		41
VZXF-L-...-G114-...-V4B2V-50-...	G1¼		62	142.5	156.5	110	34	17		50
VZXF-L-...-G114-...-V4ANV-80-...			94	177	188	110	49	17		50
VZXF-L-...-G112-...-V4B2V-50-...	G1½		62	146	165	120	34	19		55
VZXF-L-...-G112-...-V4ANV-80-...			94	181	197	120	49	19		55
VZXF-L-...-G2-...-V4ANV-80-...			G2	94	193	216.5	150	49		21

Angle seat valve VZXF

Technical data – Stainless steel casting, vacuum version

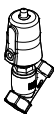
Ordering data – Angle seat valve VZXF							
	Process valve connection	Flow rate Kv [m ³ /h]	Medium pressure [bar]	Corrosion resistance CRC ¹⁾	Product weight [g]	Part No.	Type
	G1/2	3.8	-0.9	2	1300	3536502	VZXF-L-M22C-M-A-G12-130-V4B2V-50-V
	G3/4	7.5		2	1400	3536650	VZXF-L-M22C-M-A-G34-180-V4B2V-50-V
	G1	12		2	1600	3536659	VZXF-L-M22C-M-A-G34-180-V4B2V-50-V
				1	3600	3536677	VZXF-L-M22C-M-A-G1-240-V4ANV-80-V
	G1 1/4	18.5		2	2200	3536686	VZXF-L-M22C-M-A-G114-310-V4B2V-50-V
				1	3800	3536711	VZXF-L-M22C-M-A-G114-310-V4ANV-80-V
	G1 1/2	25		2	2500	3536717	VZXF-L-M22C-M-A-G112-350-V4B2V-50-V
				1	4300	3536771	VZXF-L-M22C-M-A-G112-350-V4ANV-80-V
	G2	43		1	5400	3536786	VZXF-L-M22C-M-A-G2-450-V4ANV-80-V

1) Corrosion resistance class CRC 1 to Festo standard FN 940070

Low corrosion stress. For dry indoor applications or transport and storage protection. Also applies to parts behind covers, in the non-visible interior area, and parts which are covered in the application (e.g. drive trunnions).

2) Corrosion resistance class CRC 2 to Festo standard FN 940070

Moderate corrosion stress. Indoor applications in which condensation may occur. External visible parts with primarily decorative requirements for the surface and which are in direct contact with the ambient atmosphere typical for industrial applications.

Angle seat valve VZXF

Technical data – Stainless steel casting with EX certification

Function

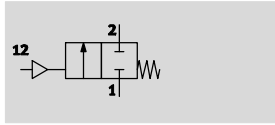

 Flow rate Kv
3.3 ... 34.5 m³/h

 G $\frac{1}{2}$... G2



General technical data			
Process valve connection	G $\frac{1}{2}$	G $\frac{3}{4}$	G1
Pneumatic connection	G $\frac{1}{8}$		
Nominal size DN	15	20	25
Nominal width [mm]	13	18	24
Valve function	2/2-way, closed, monostable		
Design	Poppet valve with spring return		
Type of mounting	In-line installation		
Mounting position	Any		
Direction of flow	Non-reversible		
Exhaust function	No flow control		
Sealing principle	Soft		
Reset method	Mechanical spring		
Type of actuation	Pneumatic		
Type of pilot control	Externally actuated		

Process valve connection	G1 $\frac{1}{4}$	G1 $\frac{1}{2}$	G2
Pneumatic connection	G $\frac{1}{8}$		
Nominal size DN	32	40	50
Nominal width [mm]	31	35	45
Valve function	2/2-way, closed, monostable		
Design	Poppet valve with spring return		
Type of mounting	In-line installation		
Mounting position	Any		
Direction of flow	Non-reversible		
Exhaust function	No flow control		
Sealing principle	Soft		
Reset method	Mechanical spring		
Type of actuation	Pneumatic		
Type of pilot control	Externally actuated		

Angle seat valve VZXF

Technical data – Stainless steel casting with EX certification

Operating and environmental conditions						
Process valve connection Variant	G1/2 ...-M-A-... ...-M-B-...		G3/4 ...-M-A-... ...-M-B-...		G1 ...-M-A-... ...-M-B-...	
Nominal pressure of process valve PN	40					
Operating pressure [bar]	6 ... 10					
Operating medium	Compressed air to ISO 8573-1:2010 [7:4:4]					
Medium	Steam					
	Inert gases					
	Filtered compressed air, degree of filtration 200 µm					
	–	Mineral oil-based hydraulic oil	–	Mineral oil-based hydraulic oil	–	Mineral oil-based hydraulic oil
	–	Mineral oil	–	Mineral oil	–	Mineral oil
	–	Neutral fluids	–	Neutral fluids	–	Neutral fluids
–	Water	–	Water	–	Water	
Max. viscosity [mm ² /s]	600					
Ambient temperature [°C]	–10 ... +60					
Temperature of medium [°C]	–40 ... +200					
ATEX category for gas	II 2G					
Type of ignition protection for gas	c TX X					
ATEX category for dust	II 2D					
Type of ignition protection for dust	c TX X					
Explosion-proof temperature	–10 °C ≤ Ta ≤ +60 °C					
CE marking (see declaration of conformity)	As per EU Explosion Protection Directive (ATEX)					

Process valve connection Variant	G1 1/4 ...-M-A-... ...-M-B-...		G1 1/2 ...-M-A-... ...-M-B-...		G2 ...-M-A-... ...-M-B-...	
Nominal pressure of process valve PN	40					
Operating pressure [bar]	6 ... 10					
Operating medium	Compressed air to ISO 8573-1:2010 [7:4:4]					
Medium	Steam					
	Inert gases					
	Filtered compressed air, degree of filtration 200 µm					
	–	Mineral oil-based hydraulic oil	–	Mineral oil-based hydraulic oil	–	Mineral oil-based hydraulic oil
	–	Mineral oil	–	Mineral oil	–	Mineral oil
	–	Neutral fluids	–	Neutral fluids	–	Neutral fluids
–	Water	–	Water	–	Water	
Max. viscosity [mm ² /s]	600					
Ambient temperature [°C]	–10 ... +60					
Temperature of medium [°C]	–40 ... +200					
ATEX category for gas	II 2G					
Type of ignition protection for gas	c TX X					
ATEX category for dust	II 2D					
Type of ignition protection for dust	c TX X					
Explosion-proof temperature	–10 °C ≤ Ta ≤ +60 °C					
CE marking (see declaration of conformity)	To EU Pressure Equipment Directive As per EU Explosion Protection Directive (ATEX)					

Angle seat valve VZXF

Technical data – Stainless steel casting with EX certification

Materials		
Angle seat valves		Material number
1 Housing	Stainless steel casting	1.4408
2 Actuator head	Stainless steel	-
3 Stem seal	PTFE	-
Seat seal	PTFE	-
- Note on materials	Contains paint-wetting impairment substances, RoHS compliant	

Dimensions Download CAD data → www.festo.com

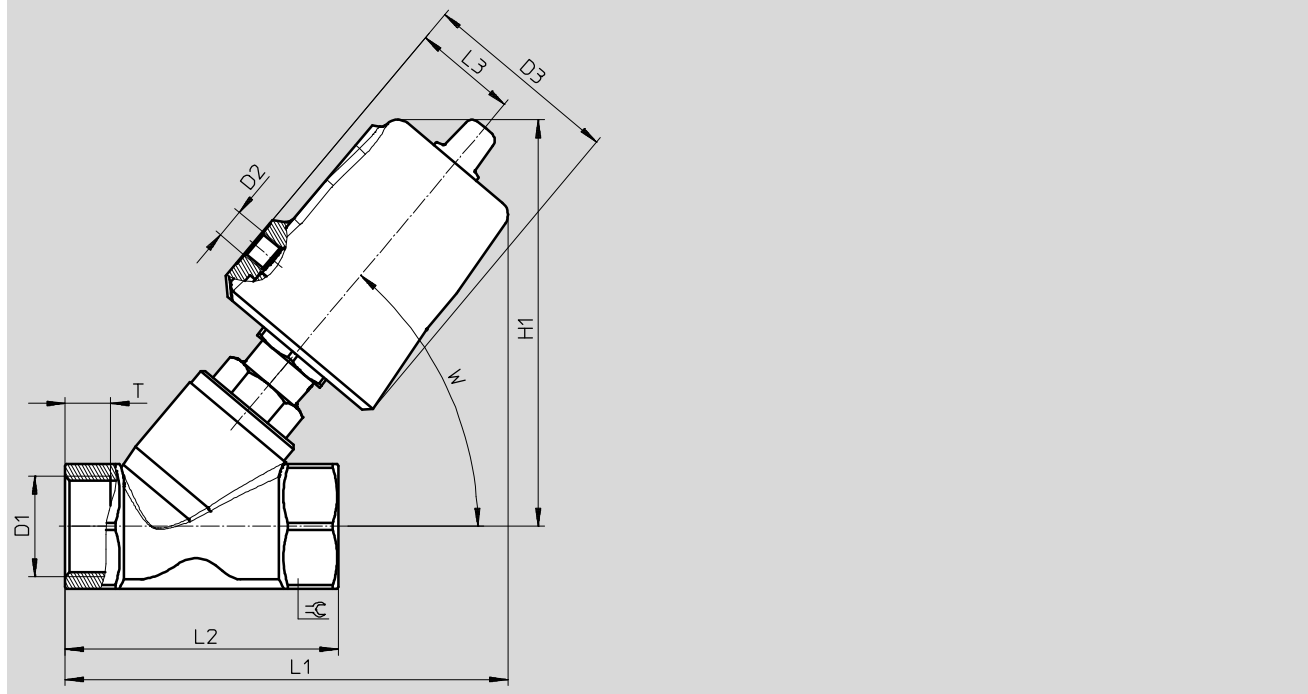

	D1	D2	D3 Ø	H1	L1	L2	L3	T	W	☉
VZXF-L-...-G12-...-V4V4T-50-...	G½	G⅛	62	129	135	65	34	12	50°	27
VZXF-L-...-G34-...-V4V4T-50-...	G¾			130	138	75		13		32
VZXF-L-...-G1-...-V4V4T-50-...	G1			135	146	90		15		42
VZXF-L-...-G114-...-V4V4T-50-...	G1¼			151	155	110		17		50
VZXF-L-...-G112-...-V4V4T-50-...	G1½			155	174	120		19		55
VZXF-L-...-G2-...-V4V4T-50-...	G2			167	193	150		21		70

Angle seat valve VZXF

Technical data – Stainless steel casting with EX certification

Ordering data – Angle seat valve VZXF							
	Process valve connection	Flow rate Kv [m ³ /h]	Medium pressure [bar]	Corrosion resistance CRC ¹⁾	Product weight [g]	Part No.	Type
	G $\frac{1}{2}$	3.3	0 ... 40	3	1300	3539723	VZXF-L-M22C-M-B-G12-130-M1-V4V4T-50-40-EX4
		3.8				3539024	VZXF-L-M22C-M-A-G12-130-M1-V4V4T-50-40-EX4
	G $\frac{3}{4}$	6.5	0 ... 20		1400	3539749	VZXF-L-M22C-M-B-G34-180-M1-V4V4T-50-20-EX4
		7.5				3539748	VZXF-L-M22C-M-A-G34-180-M1-V4V4T-50-20-EX4
	G1	11	0 ... 10		1600	3539787	VZXF-L-M22C-M-B-G1-240-M1-V4V4T-50-10-EX4
		12	0 ... 16			3539786	VZXF-L-M22C-M-A-G1-240-M1-V4V4T-50-16-EX4
	G1 $\frac{1}{4}$	10.7	0 ... 7		2200	3539820	VZXF-L-M22C-M-B-G114-310-M1-V4V4T-50-7-EX4
		18.5	0 ... 9			3539819	VZXF-L-M22C-M-A-G114-310-M1-V4V4T-50-9-EX4
	G1 $\frac{1}{2}$	17.5	0 ... 6		2500	3539931	VZXF-L-M22C-M-B-G112-350-M1-V4V4T-50-6-EX4
		25	0 ... 7			3539930	VZXF-L-M22C-M-A-G112-350-M1-V4V4T-50-7-EX4
	G2	19.5	0 ... 3		3500	3540148	VZXF-L-M22C-M-B-G2-450-M1-V4V4T-50-3-EX4
		34.5	0 ... 4			3540147	VZXF-L-M22C-M-A-G2-450-M1-V4V4T-50-4-EX4

1) Corrosion resistance class CRC 3 to Festo standard FN 940070

High corrosion stress. Outdoor exposure under moderate corrosive conditions. External visible parts with primarily functional requirements for the surface and which are in direct contact with a normal industrial environment.