

Soft Start-up Valve

Start-up valve for low speed air supply to gradually raise initial pressure in an air system and for quick exhaust by cutting off air supply

New



[See page 3.]



IP65

DIN terminal only

Power consumption: 0.35 W

* At 12/24 VDC

Current model: 1.8 W (80% reduction)

Improved flow rate characteristics:

Up to 2.3 times

C[dm³/(s·bar)]: 9.2

* For AV2000-A

Energy saving

No air flow when the main valve is switched.



AV2000-A/3000-A/4000-A/5000-A Series



CAT.ES40-63A

Improved flow rate characteristics*1 : Up to 2.3 times

C[dm³/(s·bar)]: 9.2 Fill time: Up to 50% shorter

*1 For high speed air supply

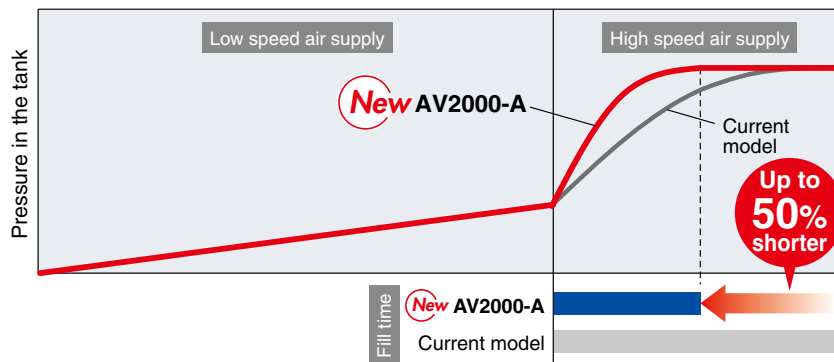
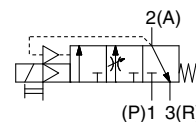

C[dm³/(s·bar)]

Body size	AV-A	Current model
20	9.2	4
30	13.1	7.4
40	19.2	12.2
50 (Port size 3/4)	34.8	22.6
50 (Port size 1")	41.3	24.4

For 1(P) → 2(A)

Improved adjustability at low speed air supply

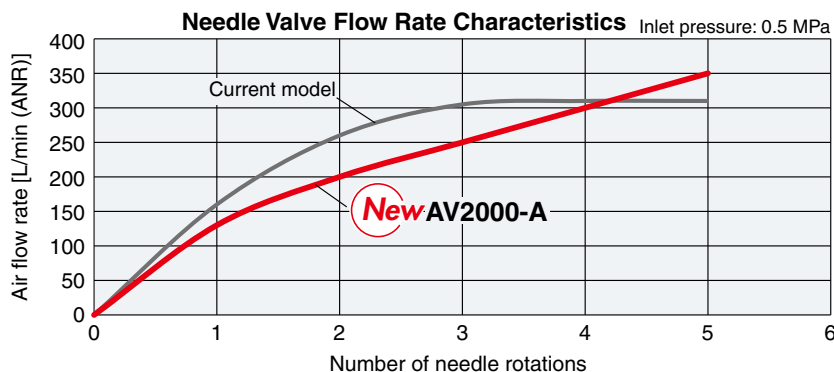

Smaller profile and less work hours due to integrated silencer

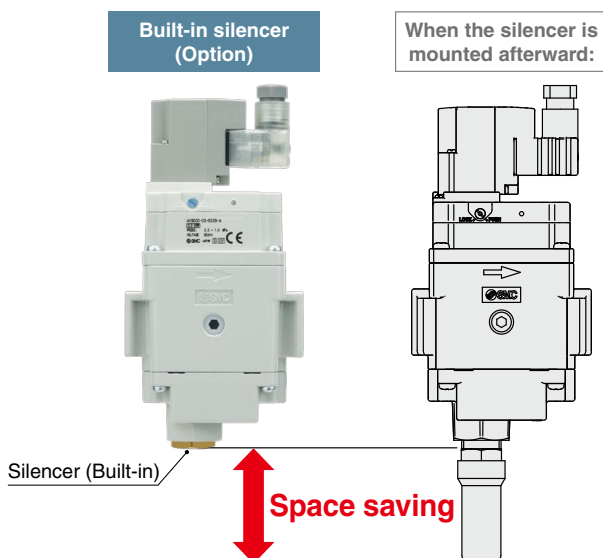

Model	Shortened dimensions [mm]	Silencer part number (when mounted afterward)
AV2000-□S-A	37	AN20-02
AV3000-□S-A	49	AN30-03
AV4000-□S-A	56	AN40-04
AV5000-□S-A	92	AN500-06

Energy saving

When switching the main valve (exhaust → low speed air supply), the flow passage to port 3 (R) is closed with the main valve. Therefore, air does not blow out to the outside.

Variations

Series	C [dm ³ /(s·bar)]	Port size		Voltage	Electrical entry	Option
		1(P), 2(A)	3(R)			
AV2000-A	9.2	1/4	1/4	100 VAC 200 VAC 110 VAC 220 VAC 24 VDC 12 VDC	• Grommet • DIN terminal	• Bracket • Pressure gauge • Silencer (Built-in)
AV3000-A	13.1	3/8	3/8			
AV4000-A	19.2	1/2	1/2			
AV5000-A	34.8	3/4	3/4			
	41.3	1				

Options



Pilot Valve Variations

DIN terminal with connector
Type D
Type Y*1

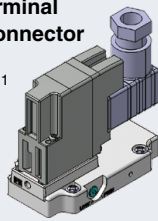

DIN terminal without connector
Type D
Type Y*1

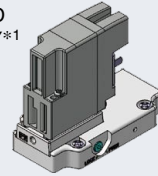

Grommet

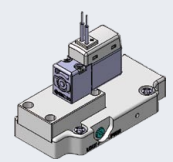

*1 A DIN terminal conforming to EN-175301-803C (former DIN43650C)

Manual Override Variations

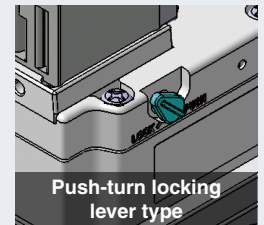
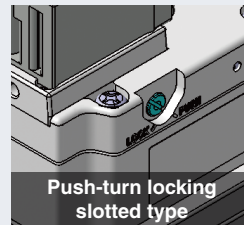

Combination with F.R.L. Units

Series	Port size	F.R.L. units					
		AC20	AC25	AC30	AC40*1	AC5□	AC60
AV2000-A	1/4	●					
AV3000-A	3/8		●	●			
AV4000-A	1/2				●		
AV5000-A	3/4					●	
	1						●

*1 Except port size 06

Connection Example

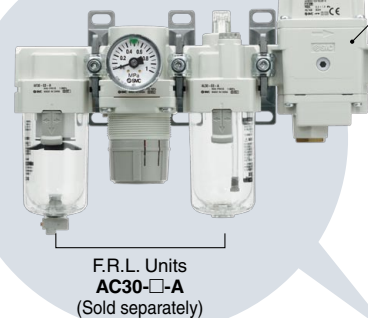

Soft Start-up Valve AV3000-A

Application Example

For slow air supply when starting-up and for rapid air exhaust after stopping the equipment.



Simple Specials System

Unit with F.R.L is available with the simple special ordering system. The lead time is almost the same as the standard product. Please contact your local sales representative for more details.

Soft Start-up Valve

AV2000-A/3000-A/4000-A/5000-A Series

Symbol

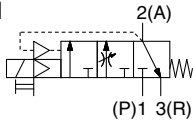

How to Order

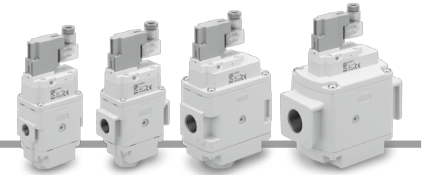

AV **20** **00** - **02** **B** - **1** **D** **B** - - **A**

① ② ③ ④ ⑤ ⑥ ⑦ ⑧ ⑨

*1 CE compliant

	Electrical entry	
	Grommet	DIN terminal
AC	—	●
DC	●	●

		Symbol	Description	①					
				Body size					
				20	30	40	50		
②	Thread type	Nil	Rc	●	●	●	●		
		N	NPT	●	●	●	●		
		F	G	●	●	●	●		
		+							
③	Port size 1(P), 2(A)	02	1/4	●	—	—	—		
		03	3/8	—	●	—	—		
		04	1/2	—	—	●	—		
		06	3/4	—	—	—	●		
		10	1	—	—	—	●		
		+							
④	a	Mounting	Nil	Without mounting option	●	●	●	●	
			B	With bracket	●	●	●	●	
			+						
	b	Pressure gauge	Nil	Without pressure gauge	●	●	●	●	
			G	Round type pressure gauge (with limit indicator)	●	●	●	●	
			+						
c	Silencer	Nil	Without silencer	●	●	●	●		
		S	Silencer (Built-in)	●	●	●	●		
		+							
⑤	d	Rated coil voltage	AC (50/60 Hz)	1	100 VAC	●	●	●	●
				2	200 VAC	●	●	●	●
				3	110 VAC [115 VAC]*1	●	●	●	●
			DC	4	220 VAC [230 VAC]*1	●	●	●	●
				5	24 VDC	●	●	●	●
				6	12 VDC	●	●	●	●
		+							
⑥	e	Electrical entry	G	Grommet (Lead wire length: 300 mm)	●	●	●	●	
			D	Type D (DIN terminal/With connector)	●	●	●	●	
			Y	Type Y (DIN terminal/With connector)*2	●	●	●	●	
			DO	Type D (DIN terminal/Without connector)	●	●	●	●	
			YO	Type Y (DIN terminal/Without connector)	●	●	●	●	
		+							
⑦	f	Light/ surge voltage suppressor	Nil	None	●	●	●	●	
			Z	With light/surge voltage suppressor	○*3	○*3	○*3	○*3	
		+							
⑧	g	Manual override	B	Push-turn locking slotted type	●	●	●	●	
			C	Push-turn locking lever type	●	●	●	●	
		+							
⑨	h	Flow direction	Nil	Flow direction: Left to right	●	●	●	●	
			R	Flow direction: Right to left	●	●	●	●	
			+						
i	Pressure unit	Nil	Name plate and pressure gauge in SI units: MPa	●	●	●	●		
		Z	Name plate and pressure gauge in imperial units: psi	○*4	○*4	○*4	○*4		

*1 The 110 VAC and 115 VAC are interchangeable. The 220 VAC and 230 VAC are interchangeable as well.

The allowable voltage fluctuation is -15% to +5% of the rated voltage for the 115 VAC or 230 VAC.

*2 Type "Y" is a DIN terminal conforming to EN-175301-803C (former DIN43650C).

*3 When the electrical entry is DO or YO, light/surge voltage suppressor cannot be selected.

*4 Only for the NPT thread

• Option: Select one each for a to c.

• Option symbol: When more than one specification is required, indicate in alphabetical order.

Example) AV2000-02BGS-1DB-A

Soft Start-up Valve **AV2000-A/3000-A/4000-A/5000-A Series**

Specifications

Series		AV2000-A	AV3000-A	AV4000-A	AV5000-A	
Port size	1(P), 2(A)	1/4	3/8	1/2	3/4	1
	3(R)	1/4	3/8	1/2	3/4	
Pressure gauge port size		1/8				
Fluid		Air				
Ambient and fluid temperature		0 to 50°C*1				
Proof pressure		1.5 MPa				
Operating pressure range		0.2 to 1.0 MPa				
Weight [kg]		0.43	0.45	0.80	1.30	1.25
Enclosure		Dust-protected (DIN terminal: IP65*2)				

*1 If the temperature is low, use the product with dry air to prevent it from freezing.

*2 Based on IEC60529

Solenoid Specifications

Electrical entry		Grommet		DIN terminal		
Rated coil voltage [V]	DC	24, 12 V				
	AC	50/60 Hz				
Allowable voltage fluctuation	DC	24 V	±10% of the rated voltage			
		12 V	±10% of the rated voltage			
	AC	100 V	±10% of the rated voltage			
		110 V*1	±10% of the rated voltage			
		[115 V]	[-15% to +5% of the rated voltage]			
		200 V	±10% of the rated voltage			
		220 V*1	±10% of the rated voltage			
[230 V]	[-15% to +5% of the rated voltage]					
Power consumption [W]	DC	0.35 (With light: 0.4)		0.35 (With light: 0.45)		
Apparent power [VA]	AC	100 V	0.78 (With light: 0.81)		0.78 (With light: 0.87)	
		110 V	0.86 (With light: 0.89)		0.86 (With light: 0.97)	
		[115 V]	[0.94 (With light: 0.97)]		[0.94 (With light: 1.07)]	
		200 V	1.18 (With light: 1.22)		1.15 (With light: 1.30)	
		220 V	1.30 (With light: 1.34)		1.27 (With light: 1.46)	
[230 V]	[1.42 (With light: 1.46)]		[1.39 (With light: 1.60)]			
Surge voltage suppressor		Refer to the Specific Product Precautions 4 on page 13.				
Indicator light		LED		LED (Neon bulb for AC)		

*1 The 110 VAC and 115 VAC are interchangeable. The 220 VAC and 230 VAC are interchangeable as well.

Flow Rate Characteristics

Series		AV2000-A	AV3000-A	AV4000-A	AV5000-A		
Port size	1(P), 2(A)	1/4	3/8	1/2	3/4	1	
	3(R)	1/4	3/8	1/2	3/4		
Flow rate characteristics	1(P) → 2(A)	C[dm ³ /(s·bar)]	9.2	13.1	19.2	34.8	41.3
		b	0.36	0.27	0.32	0.66	0.34
		Cv	2.4	3.1	5.1	12.6	13.7
	2(A) → 3(R)	C[dm ³ /(s·bar)]	8.8	9.2	10.1	23.7	
		b	0.46	0.48	0.55	0.67	
		Cv	2.5	2.6	3.2	9.2	

Pressure for switching from low speed air supply to rapid air supply

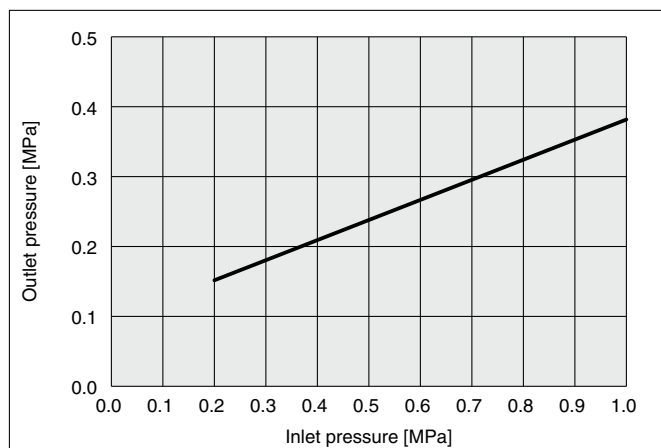

Needle flow characteristics at low speed air supply * Representative values

Inlet pressure: 0.5 MPa

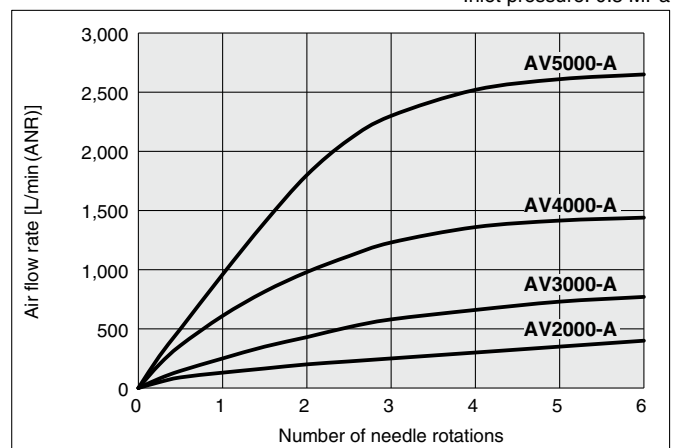

AV2000-A/3000-A/4000-A/5000-A Series

Optional Part Nos.

Series	AV2000-A	AV3000-A	AV4000-A	AV5000-A
Bracket assembly*1	AV22P-210AS	AV32P-210AS	AV42P-210AS	AV52P-210AS
Silencer assembly*2	VHS30PW-190AS	VHS40PW-190AS	VHS40PW-190-06AS	AV52P-250AS
Pressure gauge*3	G36-10-□01			

*1 Bracket: 1 pc., Mounting screw: 2 pcs. (3 pcs. for AV5000-A)

*2 Element, Element O-ring, Element cover: 1 pc. for each

*3 □ of the pressure gauge part number will indicate the connecting screw type. No indication is necessary for R; however, indicate N for NPT.
Please contact SMC regarding the pressure gauge supply for psi unit specifications.

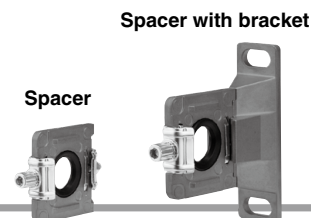

Connecting Spacer for Modular Type F.R.L. Unit

Series	AV2000-A	AV3000-A	AV4000-A	AV5000-A
Spacer	Y200-A	Y300-A	Y400-A	Y600-A
Spacer with bracket	Y200T-A	Y300T-A	Y400T-A	Y600T-A
Applicable model	AC20-A AC20-B	AC25-A, AC30-A AC25-B, AC30-B	AC40-A*1 AC40-B*1	AC50-B, AC55-B AC60-B

*1 Except port size 06

Assembly Example

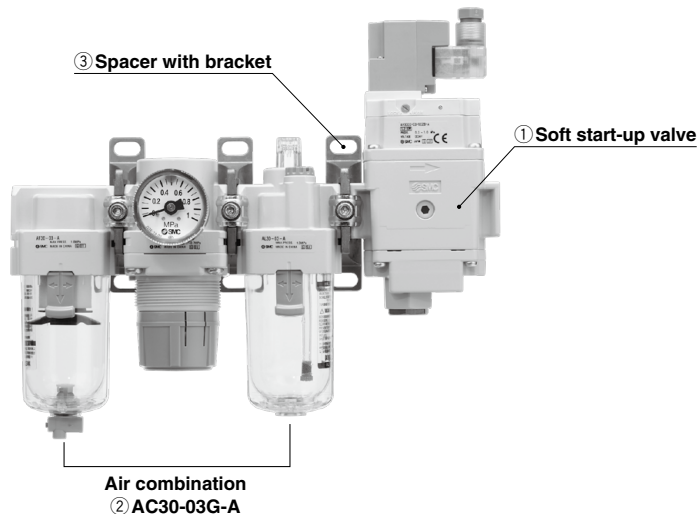

Products do not come assembled. They should be ordered separately and assembled by the customer.

* The Simple Specials System deals with product unification.
Please contact your local sales representative for more details.

Assembly example

- ① Soft start-up valve: AV3000-03S-5DZB-A 1 pc.
- ② Air combination: AC30-03G-A 1 pc.
- ③ Spacer with bracket: Y300T-A 1 pc.

Working Principle

Working conditions	Pilot valve	Pressure conditions	Operation description	Internal construction/Cylinder actuation circuit (Meter-out control) example
Low speed air supply	ON	$P_s > P_A$	<p>Operation description of the soft start-up valve</p> <p>When the pilot valve ① is energized or turned ON manually, the spool ② is pushed down due to the pilot air and gets into contact with the valve ③, closing the flow passage to port 3 (R). At this time, force that pushes the valve ③ \geq force that pushes down the spool ②. Therefore, the flow passage from the valve ③ to port 2 (A) is still closed.</p> <p>Furthermore, the piston ④ is pushed down due to the pilot air, and the flow passage from the needle ⑤ to port 2 (A) opens. And then, the air pressure whose flow rate is adjusted by the needle ⑤ flows to port 2 (A).</p> <p>Description of cylinder actuation</p> <p>The meter-in control of the needle ⑤ slowly moves the cylinder from A to B.</p> <p>PP: Inlet pressure PA: Outlet pressure</p>	
High speed air supply		$P_s \leq P_A$	<p>Operation description of the soft start-up valve</p> <p>When the outlet side is filled with pressure supplied from the needle ⑤, P_A increases. When P_A exceeds the specified pressure, the force that pushes up the valve ③ becomes smaller than the force that pushed down the spool ②. Then, the valve ③ is pushed down, opening the flow passage, and pressure is supplied to port 2 (A) rapidly.</p> <p>Description of cylinder actuation</p> <p>When $P_s < P_A$ after the cylinder reaches B, the main valve fully opens and P_A increases rapidly as shown from C to D and becomes the same pressure as P_p.</p> <p>P_s: Pressure for switching to rapid air supply</p>	
Normal operation		$P_p \approx P_A$	<p>Operation description of the soft start-up valve</p> <p>The valve ③ holds the fully open condition.</p> <p>Description of cylinder actuation</p> <p>The cylinder operation is controlled by a meter-out circuit on the cylinder side.</p>	
Exhaust		OFF	—	<p>Operation description of the soft start-up valve</p> <p>When the pilot valve ① is turned OFF, the pilot air of the spool ② is exhausted from the pilot valve ①, and the spool ② and valve ③ are returned upward due to the spring. This opens the flow passage to port 3 (R), exhausting the air pressure on the port 2 (A) side.</p> <p>The pilot air of the piston ④ is also exhausted from the pilot valve ①, and the piston ④ is returned upward due to the spring, closing the flow passage from the needle ⑤.</p>

AV2000-A/3000-A/4000-A/5000-A Series

Construction

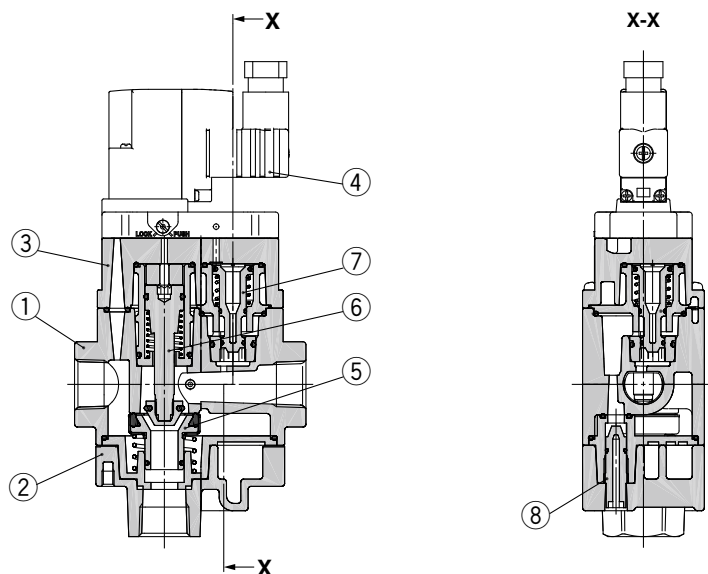

Component Parts

No.	Description	Material
1	Body	Aluminum die-cast
2	Bottom cover	Aluminum die-cast
3	Top cover	Aluminum die-cast

Replacement Parts

No.	Description	Material	AV2000-A	AV3000-A	AV4000-A	AV5000-A
4	Pilot valve assembly*1	—	See below.		See below.	
5	Valve assembly	Rubber material: HNBR	AV22P-060AS		AV42P-060AS	AV52P-060AS
6	Control valve assembly	—	AV22P-110AS		AV42P-110AS	AV52P-110AS
7	Piston assembly	POM, NBR	AV22P-120AS		AV42P-120AS	AV52P-120AS
8	Needle assembly	POM, NBR	AV22P-150AS	AV32P-150AS	AV42P-150AS	AV52P-150AS
9	Plug assembly	POM, NBR	AR22P-320AS-□01			

*1 See below for How to Order of the pilot valve.

How to Order Pilot Valve Assembly

AV **2** 0 - **1** **G** **□** **B** A

①
②
③
④
⑤

		Symbol	Description	
①	Applicable model	2	AV2000-A, AV3000-A	
		4	AV4000-A, AV5000-A	
+				
②	Rated coil voltage	AC (50/60 Hz)	1	100 VAC
			2	200 VAC
			3	110 VAC [115 VAC]*1
		DC	4	220 VAC [230 VAC]*1
			5	24 VDC
			6	12 VDC
+				
③	Electrical entry	G	Grommet (Lead wire length: 300 mm)	
		D	Type D (DIN terminal/With connector)	
		Y	Type Y (DIN terminal/With connector)*2	
		DO	Type D (DIN terminal/Without connector)	
		YO	Type Y (DIN terminal/Without connector)	
+				
④	Light/surge voltage suppressor	Nil	None	
		Z	With light/surge voltage suppressor	
+				
⑤	Manual override	B	Push-turn locking slotted type	
		C	Push-turn locking lever type	

*1 The 110 VAC and 115 VAC are interchangeable. The 220 VAC and 230 VAC are interchangeable as well. The allowable voltage fluctuation is -15% to +5% of the rated voltage for the 115 VAC or 230 VAC.

*2 Type "Y" is a DIN terminal conforming to EN-175301-803C (former DIN43650C).

* When the electrical entry is DO or YO, light/surge voltage suppressor cannot be selected.

Soft Start-up Valve AV2000-A/3000-A/4000-A/5000-A Series

Dimensions

Grommet: AV□00-□-□G□□-□-A

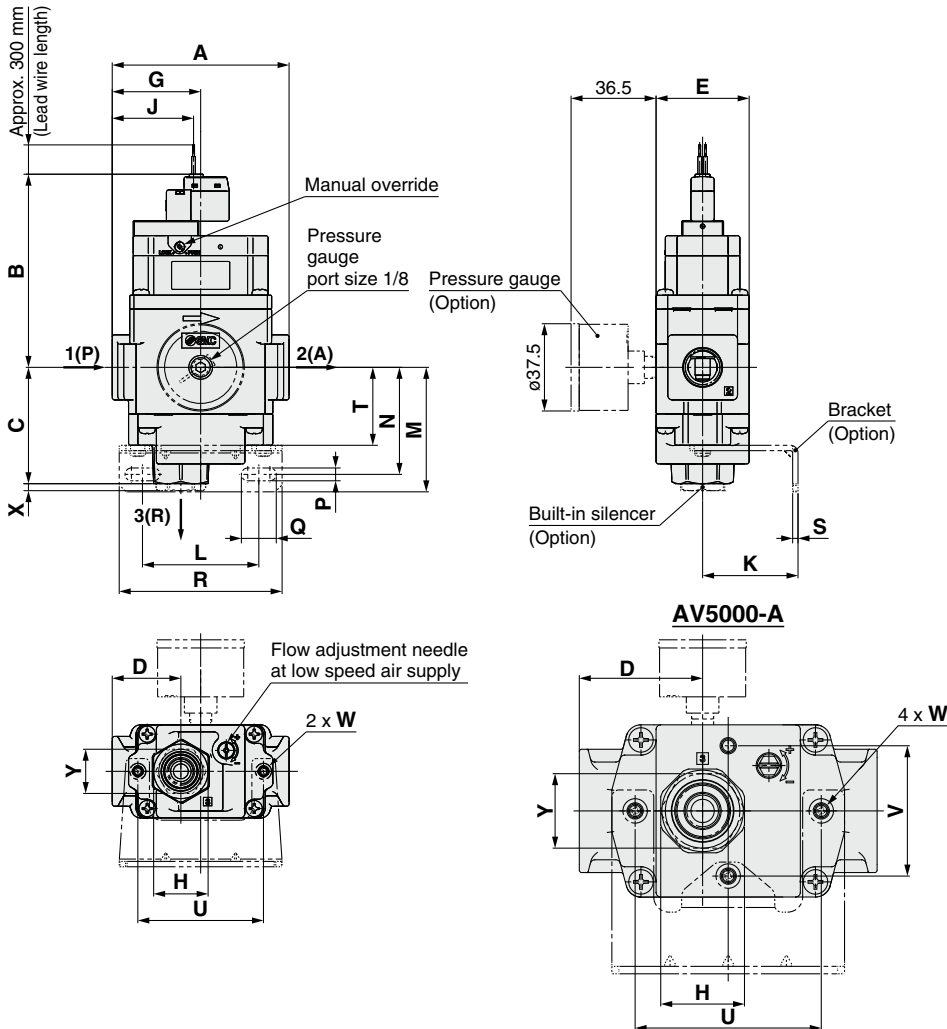

			[mm]
Body size	Coil type	B	
20	AC	85	
	DC	83	
30	AC	85	
	DC	83	
40	AC	95	
	DC	93	
50	AC	98	
	DC	96	

Dimensions

Model	Standard specifications									
	Port size			A	C	D	E	G	H	J
	1(P)	2(A)	3(R)							
AV2000-□02-1 to 4G(Z)□-A	1/4	1/4	1/4	66	47	24.5	40	33	Width across flats 22	30
AV2000-□02-5 to 6G(Z)□-A										
AV3000-□03-1 to 4G(Z)□-A	3/8	3/8	3/8	76	50	29.5	40	38	Width across flats 24	35
AV3000-□03-5 to 6G(Z)□-A										
AV4000-□04-1 to 4G(Z)□-A	1/2	1/2	1/2	98	56	39.5	52	49	Width across flats 30	33
AV4000-□04-5 to 6G(Z)□-A										
AV5000-□06, 10-1 to 4G(Z)□-A	3/4, 1	3/4, 1	3/4	128	59	53	74	53	Width across flats 36	52
AV5000-□06, 10-5 to 6G(Z)□-A										

Model	Optional specifications													
	With bracket											With built-in silencer		
	K	L	M	N	P	Q	R	S	T	U	V	W	X	Y
AV2000-□02-1 to 4G(Z)□-A	30	50	51.5	44	5.5	10	66	2.3	33.5	54	—	M4 x 0.7 Depth 6	3	Width across flats 14
AV2000-□02-5 to 6G(Z)□-A														
AV3000-□03-1 to 4G(Z)□-A	41	50	53.5	46	5.5	15	70	2.3	33.5	54	—	M4 x 0.7 Depth 6	3	Width across flats 19
AV3000-□03-5 to 6G(Z)□-A														
AV4000-□04-1 to 4G(Z)□-A	50	60	64	54	8.5	18	90	3.2	39	74	—	M5 x 0.8 Depth 6.5	4	Width across flats 22
AV4000-□04-5 to 6G(Z)□-A														
AV5000-□06, 10-1 to 4G(Z)□-A	70	75	70	60	11	16	100	3.2	45	80	56	M6 x 1 Depth 8	6	Width across flats 32
AV5000-□06, 10-5 to 6G(Z)□-A														

AV2000-A/3000-A/4000-A/5000-A Series

Dimensions

DIN terminal: AV□00-□-□D/Y□□-□-A

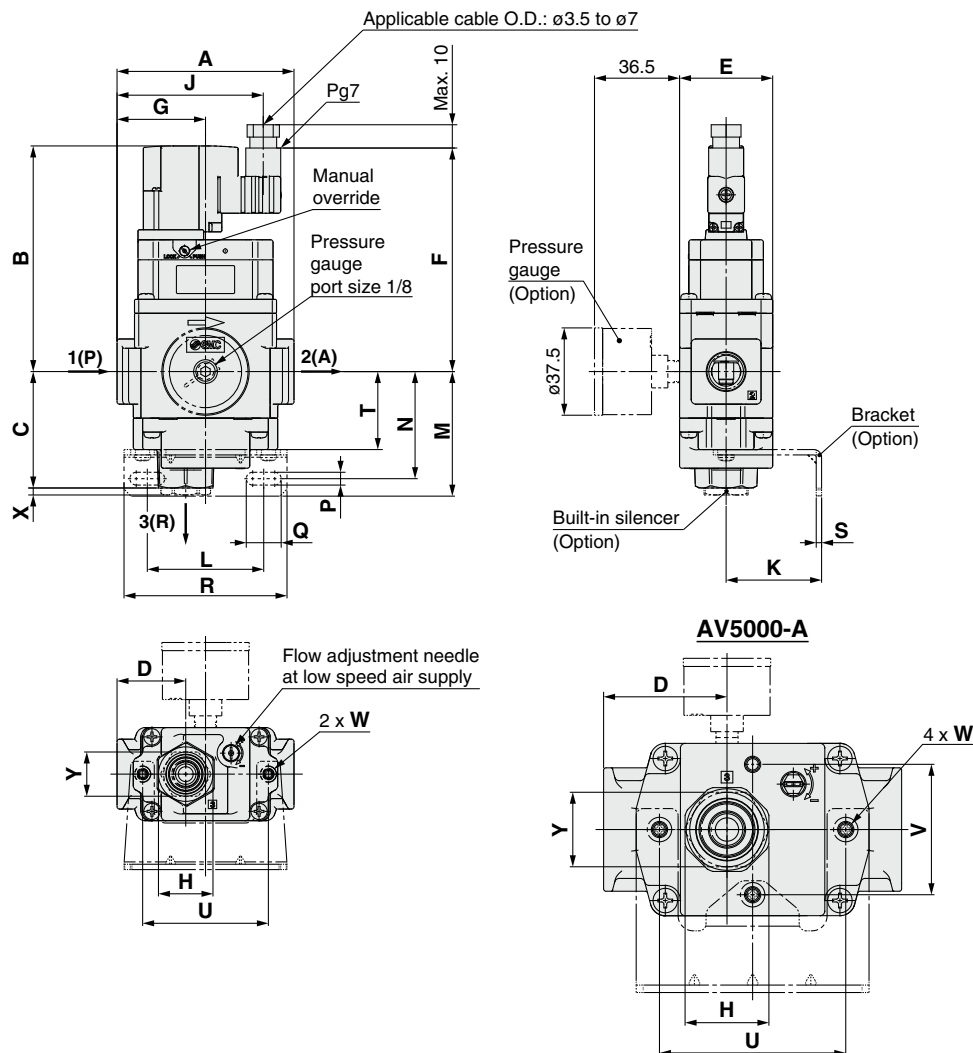

Dimensions

[mm]

Model	Standard specifications											
	Port size			A	B	C	D	E	F	G	H	J
	1(P)	2(A)	3(R)									
AV2000-□02-1 to 6D/Y(Z)□-A	1/4	1/4	1/4	66	97	47	24.5	40	96	33	Width across flats 22	58
AV3000-□03-1 to 6D/Y(Z)□-A	3/8	3/8	3/8	76	97	50	29.5	40	96	38	Width across flats 24	63
AV4000-□04-1 to 6D/Y(Z)□-A	1/2	1/2	1/2	98	107	56	39.5	52	106	49	Width across flats 30	61
AV5000-□06, 10-1 to 6D/Y(Z)□-A	3/4, 1	3/4, 1	3/4	128	109	59	53	74	108	53	Width across flats 36	80

[mm]

Model	Optional specifications													
	With bracket											With built-in silencer		
	K	L	M	N	P	Q	R	S	T	U	V	W	X	Y
AV2000-□02-1 to 6D/Y(Z)□-A	30	50	51.5	44	5.5	10	66	2.3	33.5	54	—	M4 x 0.7 Depth 6	3	Width across flats 14
AV3000-□03-1 to 6D/Y(Z)□-A	41	50	53.5	46	5.5	15	70	2.3	33.5	54	—	M4 x 0.7 Depth 6	3	Width across flats 19
AV4000-□04-1 to 6D/Y(Z)□-A	50	60	64	54	8.5	18	90	3.2	39	74	—	M5 x 0.8 Depth 6.5	4	Width across flats 22
AV5000-□06, 10-1 to 6D/Y(Z)□-A	70	75	70	60	11	16	100	3.2	45	80	56	M6 x 1 Depth 8	6	Width across flats 32



AV2000-A/3000-A/4000-A/5000-A Series Specific Product Precautions 1

Be sure to read this before handling the products. Refer to the back cover for safety instructions. For F.R.L. precautions, refer to the “Handling Precautions for SMC Products” and the “Operation Manual” on the SMC website: <http://www.smcworld.com>

Design

Warning

1. Actuator operation

When using solenoid valve or actuator in the outlet side of this product, implement appropriate measures to prevent potential danger caused by actuator operation.

2. Holding pressure

Since the valve might have slight internal leakage, it is not suitable for holding pressure in a tank or another vessel for a long period of time.

3. Not suitable for use as an emergency shutoff valve etc.

The valves listed in this catalog are not designed for safety applications such as an emergency shutoff valve. If the valves are used for the mentioned applications, additional safety measures should be adopted.

4. Ventilation

Provide ventilation when using a valve in a confined area, such as in a closed control panel. For example, install a ventilation opening etc. in order to prevent pressure from increasing inside of the confined area and to release the heat generated by the valve.

Selection

Warning

1. Confirm the specifications.

The products presented in this catalog are designed only for use in compressed air systems. Do not operate at pressures, temperatures, etc., beyond the range of the specifications, as this can cause damage or malfunction. (Refer to the specifications.) Please contact SMC if using for other fluids than compressed air.

2. Operation of closed center solenoid valves

Even if this product is used for closed center solenoid valves or actuator with a load factor of 50% or more, lurching (quick extension) cannot be prevented.

3. Using a regulator in the outlet side

When mounting a regulator in the outlet side (A port side), use a residual pressure relief regulator (AR25K to 40K) or a check type regulator. With a standard regulator (AR10 to 60), the outlet side pressure may not be released when this valve is exhausted.

4. Operation of solenoid valves in the outlet side

To operate solenoid valves mounted on this product's outlet side (A port side), first confirm that the outlet side's pressure (P_A) has increased to become equal to the inlet side's pressure (P_P).

5. Operation

The residual pressure release function of this product is for emergency use only; therefore, avoid the operation in the same manner as ordinary 3 port valves.

6. Using a lubricator

If mounting a lubricator, mount it on the inlet side (P port side), of this product. If mounted on the outlet side (A port side), back flow of oil will occur and may spurt out of the valve's R port.

Selection

Warning

7. Operation for air blowing

This product cannot be operated for air blowing due to the mechanism that switches the main valve to be fully open after the outlet side's pressure increases to approximately 1/2 of the inlet side.

Caution

1. Leakage voltage

Particularly when using a C-R element (surge voltage suppressor) to protect the switching element, take note that leakage current will flow through the C-R element, thus increasing leakage voltage.

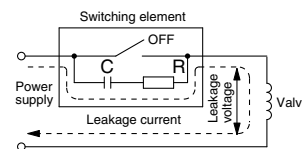

AC coil is 8% or less of the rated voltage.

DC coil is 3% or less of the rated voltage.

2. Low temperature operation

Although the valve can be operated at temperature as low as 0°C, measures should be taken to avoid solidifying or freezing drainage and moisture, etc.

Mounting

Warning

1. If air leakage increases or equipment does not operate properly, stop operation.

After mounting or maintenance, etc., connect the compressed air and power supplies, and perform appropriate function and leakage tests to confirm that the unit is mounted properly.

2. Operation manual

Mount and operate the product after reading the manual carefully and understanding its contents. Also, keep the manual in a place where it can be referred to as necessary.

3. Painting and coating

Warnings or specifications printed or labeled on a product should not be erased, removed or covered up. Furthermore, please contact SMC before painting the resin parts, as this may cause adverse effects depending on the solvent.

4. Maintenance space

Allow sufficient space for maintenance and inspection.



AV2000-A/3000-A/4000-A/5000-A Series

Specific Product Precautions 2

Be sure to read this before handling the products. Refer to the back cover for safety instructions. For F.R.L. precautions, refer to the "Handling Precautions for SMC Products" and the "Operation Manual" on the SMC website: <http://www.smcworld.com>

Adjustment

⚠ Caution

1. To perform the initial speed adjustment of the outlet side actuator, supply air from this valve's inlet side and turn ON the pilot valve. Then, rotate the needle counterclockwise from the fully closed position.

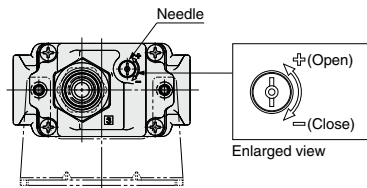

Piping

⚠ Warning

1. **Preparation before piping**
Before piping is connected, it should be thoroughly blown out by air (flushing) or washed to remove chips, cutting oil, and other debris from inside the pipe.
2. **Winding of sealant tape**
When screwing together pipes and fittings, etc., be certain that chips from the pipe threads and sealing material do not get inside the valve. Also, when the sealant tape is used, leave 1.5 to 2 thread ridges exposed at the end of the threads.

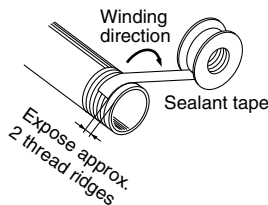

3. **Tighten threads with the proper tightening torque.**
When screwing fittings into valves, tighten with the torques given below.

Tightening Torque when Piping

Connection thread	Proper tightening torque [N·m]
Rc 1/4	12 to 14
Rc 3/8	22 to 24
Rc 1/2	28 to 30
Rc 3/4	28 to 30
Rc 1	36 to 38

4. **Piping to products**
When piping to products, avoid making an error of supply port etc., by referring to the operation manuals.
5. **F.R.L. module combination**
When connecting to a modular F.R.L. combinations (AC20 to 60), select one of the spacers, which are included. (Refer to page 5 for details.) However, modular combinations with AC40-06 are not possible. Furthermore, connect soft start-up valves to the outlet side of the F.R.L. combination.

Piping

⚠ Warning

6. **Inlet side piping conditions**
The nominal size of the piping material's or equipment's bore should be equal to or larger than the soft start-up valve's port size. The combined sonic conductance of the inlet side's (P port side's) piping or equipment should be equal to or larger than the values below.

Series	Combined sonic conductance [dm ³ /(s·bar)]
AV2000-A	1
AV3000-A	4
AV4000-A	7
AV5000-A	10

When the piping is restricted or the supply pressure is insufficient, the main valve will not switch and air leakage may occur from the R port.

Lubrication

⚠ Caution

1. The valve has been lubricated for life at the factory, and does not require any further lubrication.
2. If a lubricant is used in the system, use class 1 turbine oil (no additive), ISO VG32. For details about lubricant manufacturers' brands, refer to the SMC website. Additionally, please contact SMC for details about class 2 turbine oil (with additives) ISO VG32.
Once lubricant is utilized within the system, since the original lubricant applied within the product during manufacturing will be washed away, please continue to supply lubrication to the system. Without continued lubrication, malfunctions could occur.
If turbine oil is used, refer to the corresponding Material Safety Data Sheet (MSDS).
3. **Lubrication amount**
If the lubrication amount is excessive, the oil may accumulate inside the pilot valve, causing a malfunction or response delay. So, do not apply a large amount of oil.



AV2000-A/3000-A/4000-A/5000-A Series

Specific Product Precautions 3

Be sure to read this before handling the products. Refer to the back cover for safety instructions. For F.R.L. precautions, refer to the “Handling Precautions for SMC Products” and the “Operation Manual” on the SMC website: <http://www.smcworld.com>

Air Supply

Warning

1. Use clean air.

Do not use compressed air that contains chemicals, synthetic oils that include organic solvents, salt, corrosive gases, etc., as they can cause damage or malfunction.

Caution

1. Install an air filter.

Install an air filter upstream near the valve. Select an air filter with a filtration size of 5 μm or smaller.

2. Take measures to ensure air quality, such as by installing an aftercooler, air dryer, or water separator.

Compressed air that contains a large amount of drainage can cause a malfunction of pneumatic equipment such as valves. Therefore, take appropriate measures to ensure air quality, such as by providing an aftercooler, air dryer, or water separator.

Operating Environment

Warning

1. Do not use in an atmosphere where corrosive gases, chemicals, sea water, water, or water vapor is present. Do not use in cases where there is direct contact with any of the above.
2. Do not use in an explosive environment.
3. Do not use in a place subject to heavy vibration and/or impact.
4. The valve should not be exposed to prolonged sunlight. Use a protective cover if necessary.
5. Remove any sources of excessive heat.
6. In locations where there is contact with water, oil, weld spatter, etc., take suitable protective measures.
7. In a dusty environment or when valve switching noise is intrusive, install a silencer in the R port to prevent dust from entering, and to reduce noise.

Maintenance

Warning

1. Perform maintenance inspections according to the procedures indicated in the operation manual.

If handled improperly, malfunction and damage of machinery or equipment may occur.

2. Removal of equipment and supply/exhaust of compressed air

When components are removed, first confirm that measures are in place to prevent workpieces from dropping, run-away equipment, etc. Then, cut off the supply pressure and electric power, and exhaust all compressed air from the system using the residual pressure release function.

3. Low frequency operation

Valves should be switched at least once every 30 days to prevent a malfunction. (Use caution regarding the air supply.)

4. Manual override operation

When the manual override is operated, connected equipment will be actuated. Confirm the safety before operating.

Caution

1. Drain removal

Remove drain from air filters periodically.



AV2000-A/3000-A/4000-A/5000-A Series Specific Product Precautions 4

Be sure to read this before handling the products. Refer to the back cover for safety instructions. For F.R.L. precautions, refer to the "Handling Precautions for SMC Products" and the "Operation Manual" on the SMC website: <http://www.smcworld.com>

Manual Override Operation

Warning

Push-turn locking slotted type [Type B]

While pressing, turn in the direction of the arrow.
If it is not turned, it can be operated the same way as the non-locking type.

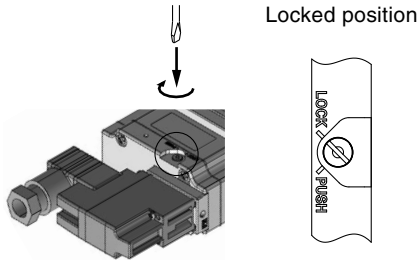

Caution

When operating the locking type D with a screwdriver, turn it gently using a watchmaker's screwdriver.
[Torque: Less than 0.1 N·m]

Push-turn locking lever type [Type C]

While pressing, turn it the direction of the arrow.
If it is not turned, it can be operated the same way as the non-locking type.

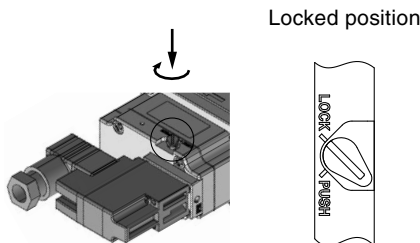

Caution

When locking the manual override on the push-turn locking types (B, C), be sure to push it down before turning.
Turning without first pushing it down can cause damage to the manual override and trouble such as air leakage etc.

Solenoid Valve for 200/220 VAC Specification

Warning

AC specification solenoid valves with grommet have a built-in rectifier circuit in the pilot section to operate the DC coil.
With 200/220 VAC specification pilot valves, this built-in rectifier generates heat when energized. The surface may become hot depending on the energized condition; therefore, do not touch the solenoid valves.

Surge Voltage Suppressor

Caution

<For DC>

Grommet

Standard type (with polarity)

With light/surge voltage suppressor (□Z)

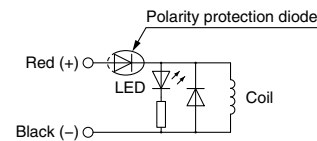

- Connect correctly the lead wires to + (positive) and - (negative) indications on the connector.
- Solenoids, whose lead wires have been pre-wired: positive side red and negative side black.

DIN Terminal

With light/surge voltage suppressor (DZ)

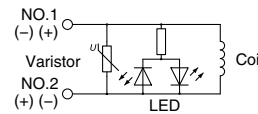

DIN terminal has no polarity.

<For AC>

Grommet

With light (GZ)

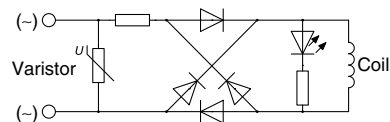

DIN Terminal

With light (DZ) (YZ)

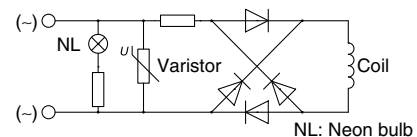

* Surge voltage suppressor of varistor has residual voltage corresponding to the protective element and rated voltage; therefore, protect the controller side from the surge. The residual voltage of the diode is approximately 1 V.



AV2000-A/3000-A/4000-A/5000-A Series Specific Product Precautions 5

Be sure to read this before handling the products. Refer to the back cover for safety instructions. For F.R.L. precautions, refer to the "Handling Precautions for SMC Products" and the "Operation Manual" on the SMC website: <http://www.smcworld.com>

How to Use DIN Terminal Connector

⚠ Caution

Connection

1. Loosen the holding screw and pull the connector out of the solenoid valve terminal block.
2. After removing the holding screw, insert a flat blade screwdriver etc. into the notch on the bottom of the terminal block and pry it open, separating the terminal block and the housing.
3. Loosen the screw (slotted screws) in the terminal block. Insert the lead core wires to the terminals according to the connection method, and secure the wires by re-tightening the terminal screw.
4. Secure the cord by tightening the gland nut.

⚠ Caution

When making connections, please note that using other than the supported size ($\phi 3.5$ to $\phi 7$) heavy-duty cord will not satisfy IP65 (enclosure) standards. Also, make sure to tighten the gland nut and holding screw within their specified torque ranges.

Changing the entry direction

After separating the terminal block and housing, the cord entry can be changed by attaching the housing in the desired direction (4 directions at 90° intervals).

* When equipped with a light, be careful not to damage the light with the cord's lead wires.

Precautions

Plug in and pull out the connector vertically without tilting to one side.

Compatible cable

Cord O.D.: $\phi 3.5$ to $\phi 7$
(Reference) 0.5 mm^2 , 2-core or 3-core, equivalent to JIS C 3306

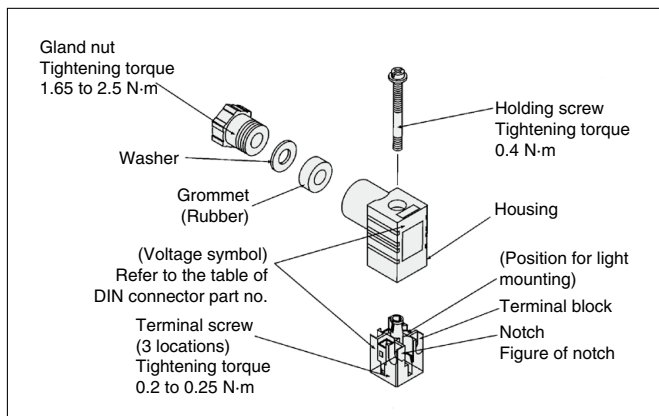

Type "Y"

Y type DIN connector is a DIN connector that conforms to the DIN pitch 8-mm standard.

- D type DIN connector with 9.4 mm pitch between terminals is not interchangeable.
- To distinguish from the D type DIN connector, "N" is listed at the end of voltage symbol. (For connector parts without lights, "N" is not indicated. Refer to the name plate to distinguish.)
- Dimensions are completely the same as D type DIN connector.

DIN Connector Part Nos.

⚠ Caution

<Type D>

Without light	SY100-61-1
---------------	------------

With light

Rated voltage	Voltage symbol	Part number
24 VDC	24 V	SY100-61-3-05
12 VDC	12 V	SY100-61-3-06
100 VAC	100 V	SY100-61-2-01
200 VAC	200 V	SY100-61-2-02
110 VAC	110 V	SY100-61-2-03
220 VAC	220 V	SY100-61-2-04

<Type Y>

Without light	SY100-82-1
---------------	------------

With light

Rated voltage	Voltage symbol	Part number
24 VDC	24 VN	SY100-82-3-05
12 VDC	12 VN	SY100-82-3-06
100 VAC	100 VN	SY100-82-2-01
200 VAC	200 VN	SY100-82-2-02
110 VAC (115 VAC)	110 VN	SY100-82-2-03
220 VAC (230 VAC)	220 VN	SY100-82-2-04

Circuit Diagram with Light

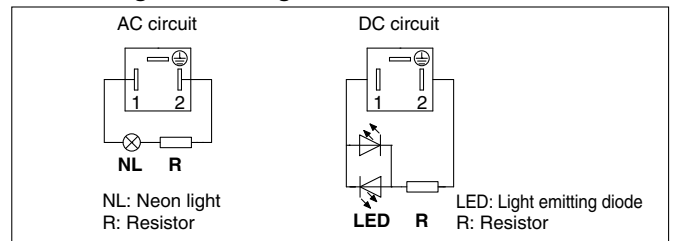

Safety Instructions

These safety instructions are intended to prevent hazardous situations and/or equipment damage. These instructions indicate the level of potential hazard with the labels of “**Caution**,” “**Warning**” or “**Danger**.” They are all important notes for safety and must be followed in addition to International Standards (ISO/IEC)*1), and other safety regulations.

 **Caution:** **Caution** indicates a hazard with a low level of risk which, if not avoided, could result in minor or moderate injury.

 **Warning:** **Warning** indicates a hazard with a medium level of risk which, if not avoided, could result in death or serious injury.

 **Danger:** **Danger** indicates a hazard with a high level of risk which, if not avoided, will result in death or serious injury.

*1) ISO 4414: Pneumatic fluid power – General rules relating to systems.
ISO 4413: Hydraulic fluid power – General rules relating to systems.
IEC 60204-1: Safety of machinery – Electrical equipment of machines.
(Part 1: General requirements)
ISO 10218-1: Manipulating industrial robots – Safety.
etc.

Warning

1. The compatibility of the product is the responsibility of the person who designs the equipment or decides its specifications.

Since the product specified here is used under various operating conditions, its compatibility with specific equipment must be decided by the person who designs the equipment or decides its specifications based on necessary analysis and test results. The expected performance and safety assurance of the equipment will be the responsibility of the person who has determined its compatibility with the product. This person should also continuously review all specifications of the product referring to its latest catalog information, with a view to giving due consideration to any possibility of equipment failure when configuring the equipment.

2. Only personnel with appropriate training should operate machinery and equipment.

The product specified here may become unsafe if handled incorrectly. The assembly, operation and maintenance of machines or equipment including our products must be performed by an operator who is appropriately trained and experienced.

3. Do not service or attempt to remove product and machinery/equipment until safety is confirmed.

1. The inspection and maintenance of machinery/equipment should only be performed after measures to prevent falling or runaway of the driven objects have been confirmed.
2. When the product is to be removed, confirm that the safety measures as mentioned above are implemented and the power from any appropriate source is cut, and read and understand the specific product precautions of all relevant products carefully.
3. Before machinery/equipment is restarted, take measures to prevent unexpected operation and malfunction.

4. Contact SMC beforehand and take special consideration of safety measures if the product is to be used in any of the following conditions.

1. Conditions and environments outside of the given specifications, or use outdoors or in a place exposed to direct sunlight.
2. Installation on equipment in conjunction with atomic energy, railways, air navigation, space, shipping, vehicles, military, medical treatment, combustion and recreation, or equipment in contact with food and beverages, emergency stop circuits, clutch and brake circuits in press applications, safety equipment or other applications unsuitable for the standard specifications described in the product catalog.
3. An application which could have negative effects on people, property, or animals requiring special safety analysis.
4. Use in an interlock circuit, which requires the provision of double interlock for possible failure by using a mechanical protective function, and periodical checks to confirm proper operation.

Caution

1. The product is provided for use in manufacturing industries.

The product herein described is basically provided for peaceful use in manufacturing industries.
If considering using the product in other industries, consult SMC beforehand and exchange specifications or a contract if necessary.
If anything is unclear, contact your nearest sales branch.

Limited warranty and Disclaimer/ Compliance Requirements

The product used is subject to the following “Limited warranty and Disclaimer” and “Compliance Requirements”.

Read and accept them before using the product.

Limited warranty and Disclaimer

1. The warranty period of the product is 1 year in service or 1.5 years after the product is delivered, whichever is first.*2)
Also, the product may have specified durability, running distance or replacement parts. Please consult your nearest sales branch.
2. For any failure or damage reported within the warranty period which is clearly our responsibility, a replacement product or necessary parts will be provided.
This limited warranty applies only to our product independently, and not to any other damage incurred due to the failure of the product.
3. Prior to using SMC products, please read and understand the warranty terms and disclaimers noted in the specified catalog for the particular products.

*2) Vacuum pads are excluded from this 1 year warranty.

A vacuum pad is a consumable part, so it is warranted for a year after it is delivered.
Also, even within the warranty period, the wear of a product due to the use of the vacuum pad or failure due to the deterioration of rubber material are not covered by the limited warranty.

Compliance Requirements

1. The use of SMC products with production equipment for the manufacture of weapons of mass destruction (WMD) or any other weapon is strictly prohibited.
2. The exports of SMC products or technology from one country to another are governed by the relevant security laws and regulations of the countries involved in the transaction. Prior to the shipment of a SMC product to another country, assure that all local rules governing that export are known and followed.

Caution

SMC products are not intended for use as instruments for legal metrology.

Measurement instruments that SMC manufactures or sells have not been qualified by type approval tests relevant to the metrology (measurement) laws of each country. Therefore, SMC products cannot be used for business or certification ordained by the metrology (measurement) laws of each country.

Safety Instructions

Be sure to read the “Handling Precautions for SMC Products” (M-E03-3) and “Operation Manual” before use.