



Brand of NTN Group

## Technical data

### UCP212-39

Bearing units



Grey cast housing, radial insert ball bearing with socket set screws, seal with slinger

### KIT CONTENT

UC212-39G2, P212

### VISUAL (S)

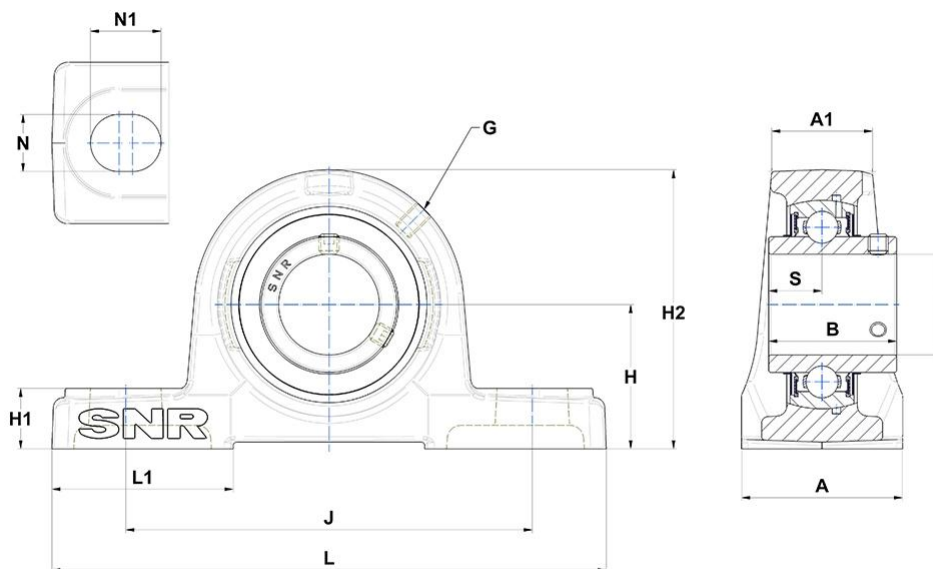

### PRODUCT DEFINITION

<b>Brand</b>	SNR
<b>A - Housing width</b>	70 mm
<b>A1 - Housing top width</b>	44 mm
<b>B - Width of Inner Ring</b>	65,1 mm
<b>d - Shaft diameter</b>	61,913 mm
<b>G - Grease fitting</b>	M6x1



**NTN Europe**

1 rue des Usines · BP 2017 · 74010 Annecy Cedex · France · Tel. +33 (0)4 50 65 30 00  
S.A. au capital de 322 639 919 € · RCS ANNECY B 325 821 072 · Id. Fiscale : FR 48 325 821 072  
SIRET 325 821 072 00015 · Code APE 2815 Z · Code NACE 28.15

### PRODUCT DEFINITION

<b>H - Distance mounting base to centerline spheric. seating diam.</b>	69,8 mm
<b>H1 - Housing foot height</b>	25 mm
<b>H2 - Housing height</b>	138 mm
<b>J - Mounting holes distance</b>	184 mm
<b>L - Housing length</b>	241 mm
<b>L1 - Housing foot length</b>	70 mm
<b>N - Mounting hole dimension</b>	20 mm
<b>N1 - Mounting hole length</b>	25 mm
<b>S - Distance front side/bearing centre</b>	25,4 mm

### PRODUCT PERFORMANCE

<b>C - Dynamic load rating</b>	52500000 mN
<b>C0 - Static load rating</b>	32800000 mN
<b>Operating temperature min.</b>	253,15 °K
<b>Operating temperature max.</b>	373,15 °K

### OTHER FEATURES

<b>Mass</b>	4,95 kg
<b>Recommended tightening torque for set screw</b>	16.8 N-m

