

Features

- 4 Pin Panel Mount
- SP25 Series
- For 25mm Panel Cutout
- Screw
- Male Contacts
- Threaded Coupling
- With Cap
- Used in Factory Automation, Robotics, Industrial Machinery, Railway & Transportation, Aerospace & Defence, Medical Equipment, Renewable Energy Systems etc.

RS PRO Industrial Circular Connectors

RS Stock No.: 0671590



RS PRO is the own brand of RS. The RS PRO Seal of Approval is your assurance of professional quality, a guarantee that every part is rigorously tested, inspected, and audited against demanding standards. Making RS PRO the Smart Choice for our customers.

Product Description

The RS PRO range of industrial circular cable connectors is engineered for robust and reliable performance in demanding environments. Featuring a circular design for secure mating and easy installation, these connectors deliver outstanding protection against dust, moisture, and mechanical stress. This makes them an ideal choice for industrial automation, robotics, and outdoor applications where durability is critical. Designed to support both power and signal transmission, the connectors offer aesthetic consistency across your project by allowing a single series to be used for multiple functions. They also provide flexible configuration options, with support for panel-to-cable and cable-to-cable connections, ensuring adaptability across a wide range of industries.

General Specifications

Number of Contacts	4
Shell Material	Polycarbonate, Nylon66, fire resistance: V-0
Insert Material	Polyphenylene Sulphide (PPS)
Contact Material	Brass Alloy
Contact Plating	Gold
Pole Format	4P
Contact Gender	Male
Mating Type	Threaded
Mating Cycles	500
Colour	Black

Electrical Specifications

Plug/Socket	Socket
Termination	Screw
Current Rating	10A
Voltage Rating	500V
Insulation Resistance	$\geq 100\text{M}\Omega$
Contact Resistance	1m Ω Max

Mechanical Specifications

Connector Size	SP25
-----------------------	------

Contact Diameter	2.5mm
Panel Cutout Diameter	25mm
Wire size (mm ² / AWG)	Min: 0.5 / 20 Max: 1.5 / 15

Operation Environment Specifications

Operating Temperature	-40°C to 85°C
-----------------------	---------------

Protection Category

IP Rating	IP68
-----------	------

Approvals

Compliance/Certifications	RoHS, CE
---------------------------	----------

Mating Parts

Cable Connector	0671642
-----------------	---------

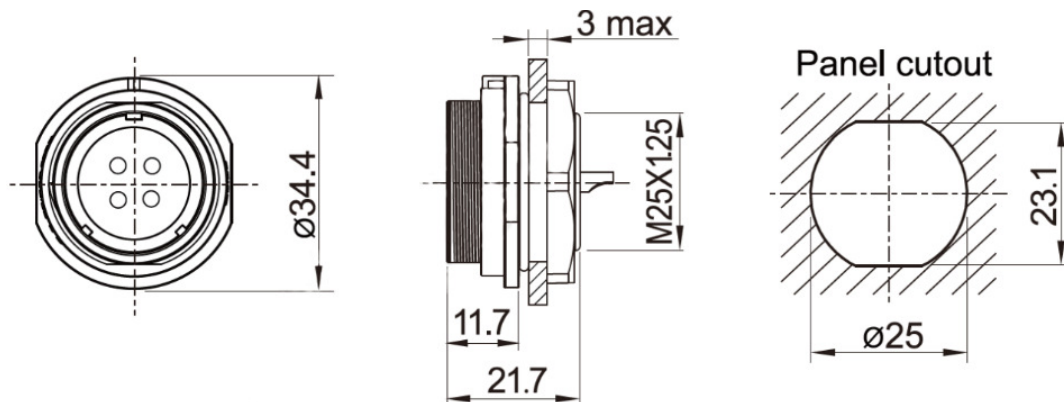

Similar Products

Parameters	0671580	0671581	0671582	0671583	0671584
Number of Contacts	2	3	4	9	10
Current Rating	10	10	10	5 & 25	10
Voltage Rating	500	500	500	500	500
Contact Gender	Female	Female	Female	Female	Female
Termination Method	Screw	Screw	Screw	Solder	Solder
Wire size (mm²)	0.5-1.5	0.5-1.5	0.5-1.5	≤0.75 & ≤4	≤2
Contact Diameter	2.5mm	2.5mm	2.5mm	1 & 2.5mm	1.5mm

Parameters	0671585	0671586	0671587	0671588
Number of Contacts	12	19	2	3
Current Rating	10	5	10	10
Voltage Rating	500	400	500	500
Contact Gender	Female	Female	Male	Male
Termination Method	Solder	Solder	Screw	Screw
Wire size (mm²)	≤2	≤0.75	0.5-1.5	0.5-1.5
Contact Diameter	1.5mm	1mm	2.5mm	2.5mm

Parameters	0671591	0671592	0671593	0671594
Number of Contacts	9	10	12	19
Current Rating	5 & 25	10	10	5
Voltage Rating	500	500	500	400
Contact Gender	Male	Male	Male	Male
Termination Method	Solder	Solder	Solder	Solder
Wire size (mm²)	≤0.75 & ≤4	≤2	≤2	≤0.75
Contact Diameter	1 & 2.5mm	1.5mm	1.5mm	1mm