

XPT IGBT

$V_{CES} = 1200V$

$I_{C25} = 78A$

$V_{CE(sat)} = 1.8V$

Copack

Part number

IXA45IF1200HB

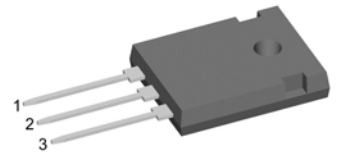

Backside: collector

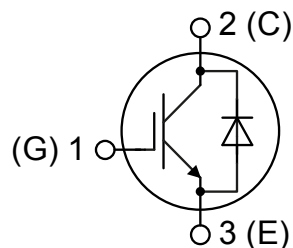
**Features / Advantages:**

- Easy paralleling due to the positive temperature coefficient of the on-state voltage
- Rugged XPT design (Xtreme light Punch Through) results in:
 - short circuit rated for 10 μ sec.
 - very low gate charge
 - low EMI
 - square RBSOA @ 3x Ic
- Thin wafer technology combined with the XPT design results in a competitive low VCE(sat)
- SONIC™ diode
 - fast and soft reverse recovery
 - low operating forward voltage

Applications:

- AC motor drives
- Solar inverter
- Medical equipment
- Uninterruptible power supply
- Air-conditioning systems
- Welding equipment
- Switched-mode and resonant-mode power supplies
- Inductive heating, cookers
- Pumps, Fans

Package: TO-247

- Industry standard outline
- RoHS compliant
- Epoxy meets UL 94V-0

IGBT				Ratings			
Symbol	Definition	Conditions	min.	typ.	max.	Unit	
V_{CES}	collector emitter voltage	$T_{VJ} = 25^{\circ}\text{C}$			1200	V	
V_{GES}	max. DC gate voltage				± 20	V	
V_{GEM}	max. transient gate emitter voltage				± 30	V	
I_{C25}	collector current	$T_C = 25^{\circ}\text{C}$			78	A	
I_{C80}		$T_C = 80^{\circ}\text{C}$			45	A	
P_{tot}	total power dissipation	$T_C = 25^{\circ}\text{C}$			325	W	
$V_{CE(sat)}$	collector emitter saturation voltage	$I_C = 35\text{A}; V_{GE} = 15\text{V}$		1.8	2.1	V	
				2.1		V	
$V_{GE(th)}$	gate emitter threshold voltage	$I_C = 1.5\text{mA}; V_{GE} = V_{CE}$	5.4	5.9	6.5	V	
I_{CES}	collector emitter leakage current	$V_{CE} = V_{CES}; V_{GE} = 0\text{V}$			0.1	mA	
				0.1		mA	
I_{GES}	gate emitter leakage current	$V_{GE} = \pm 20\text{V}$			500	nA	
$Q_{G(on)}$	total gate charge	$V_{CE} = 600\text{V}; V_{GE} = 15\text{V}; I_C = 35\text{A}$		106		nC	
$t_{d(on)}$	turn-on delay time	inductive load $V_{CE} = 600\text{V}; I_C = 35\text{A}$ $V_{GE} = \pm 15\text{V}; R_G = 27\Omega$		70		ns	
t_r	current rise time		$T_{VJ} = 125^{\circ}\text{C}$		40		ns
$t_{d(off)}$	turn-off delay time				250		ns
t_f	current fall time				100		ns
E_{on}	turn-on energy per pulse				3.8		mJ
E_{off}	turn-off energy per pulse				4.1		mJ
RBSOA	reverse bias safe operating area	$V_{GE} = \pm 15\text{V}; R_G = 27\Omega$					
I_{CM}		$V_{CEmax} = 1200\text{V}$			105	A	
SCSOA	short circuit safe operating area	$V_{CEmax} = 900\text{V}$					
t_{sc}	short circuit duration	$V_{CE} = 900\text{V}; V_{GE} = \pm 15\text{V}$			10	μs	
I_{sc}	short circuit current	$R_G = 27\Omega; \text{non-repetitive}$		140		A	
R_{thJC}	thermal resistance junction to case				0.38	K/W	
R_{thCH}	thermal resistance case to heatsink			0.25		K/W	
Diode							
V_{RRM}	max. repetitive reverse voltage	$T_{VJ} = 25^{\circ}\text{C}$			1200	V	
I_{F25}	forward current	$T_C = 25^{\circ}\text{C}$			60	A	
I_{F80}		$T_C = 80^{\circ}\text{C}$			33	A	
V_F	forward voltage	$I_F = 30\text{A}$			2.20	V	
				1.95		V	
I_R	reverse current	$V_R = V_{RRM}$			*	mA	
	* not applicable, see Ices value above				*	mA	
Q_{rr}	reverse recovery charge	$V_R = 600\text{V}$ $-di_F/dt = -600\text{A}/\mu\text{s}$ $I_F = 30\text{A}; V_{GE} = 0\text{V}$		3.5		μC	
I_{RM}	max. reverse recovery current		$T_{VJ} = 125^{\circ}\text{C}$		30		A
t_{rr}	reverse recovery time				350		ns
E_{rec}	reverse recovery energy				0.9		mJ
R_{thJC}	thermal resistance junction to case				0.7	K/W	
R_{thCH}	thermal resistance case to heatsink			0.25		K/W	

Package TO-247			Ratings			
Symbol	Definition	Conditions	min.	typ.	max.	Unit
I_{RMS}	RMS current	per terminal			70	A
T_{VJ}	virtual junction temperature		-40		150	°C
T_{op}	operation temperature		-40		125	°C
T_{stg}	storage temperature		-40		150	°C
Weight				6		g
M_D	mounting torque		0.8		1.2	Nm
F_C	mounting force with clip		20		120	N

Product Marking

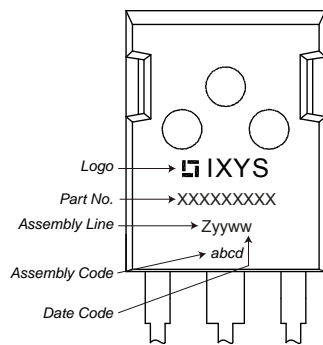

Part number

I = IGBT
 X = XPT IGBT
 A = Gen 1 / std
 45 = Current Rating [A]
 IF = Copack
 1200 = Reverse Voltage [V]
 HB = TO-247AD (3)

Ordering	Part Number	Marking on Product	Delivery Mode	Quantity	Code No.
Standard	IXA45IF1200HB	IXA45IF1200HB	Tube	30	507837

Equivalent Circuits for Simulation

* on die level

$T_{VJ} = 150\text{ °C}$

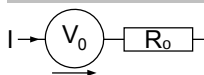

$V_{0\max}$ threshold voltage

$R_{0\max}$ slope resistance *

	IGBT	Diode	
$V_{0\max}$	1.1	1.25	V
$R_{0\max}$	39	28.3	mΩ

Outlines TO-247

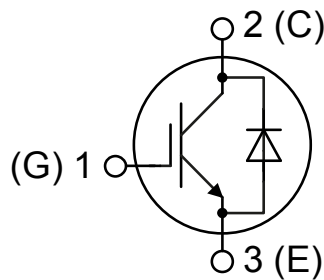
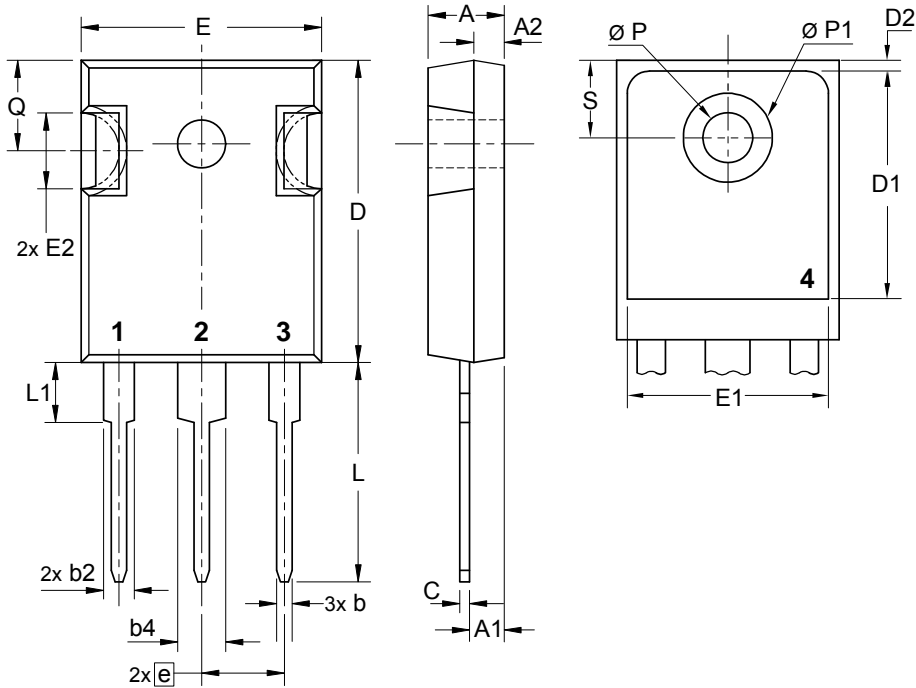

IGBT

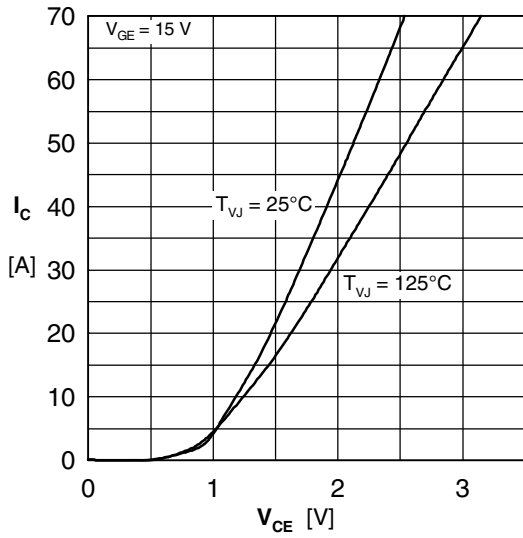

Fig. 1 Typ. output characteristics

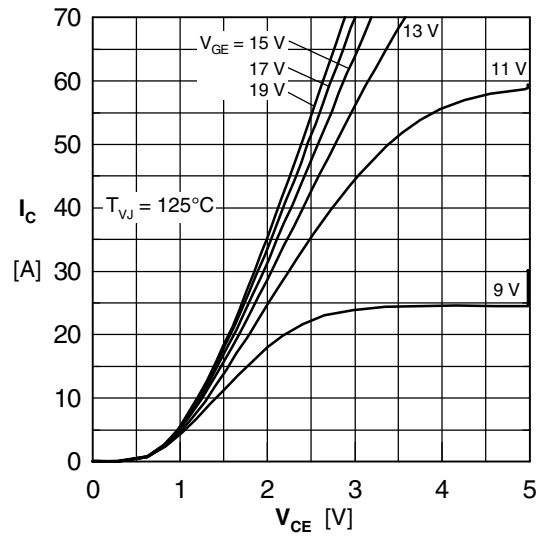

Fig. 2 Typ. output characteristics

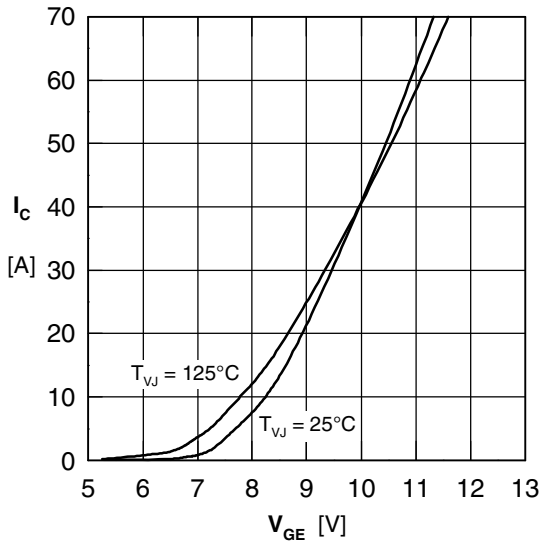

Fig. 3 Typ. transfer characteristics

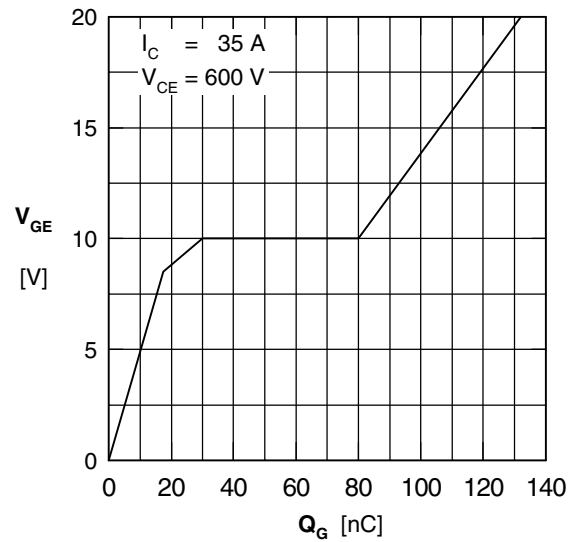

Fig. 4 Typ. turn-on gate charge

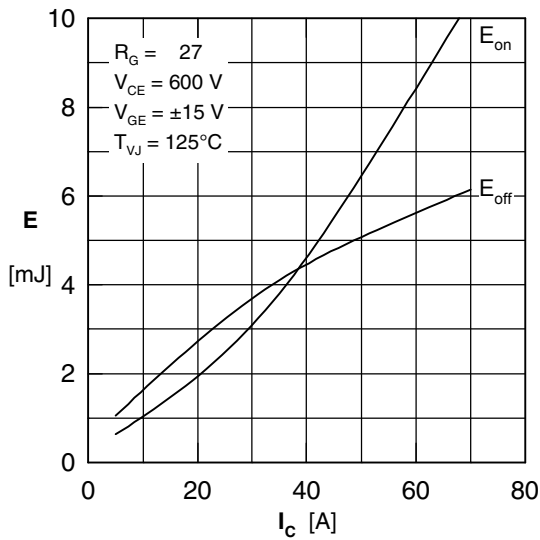

Fig. 5 Typ. switching energy vs. collector current

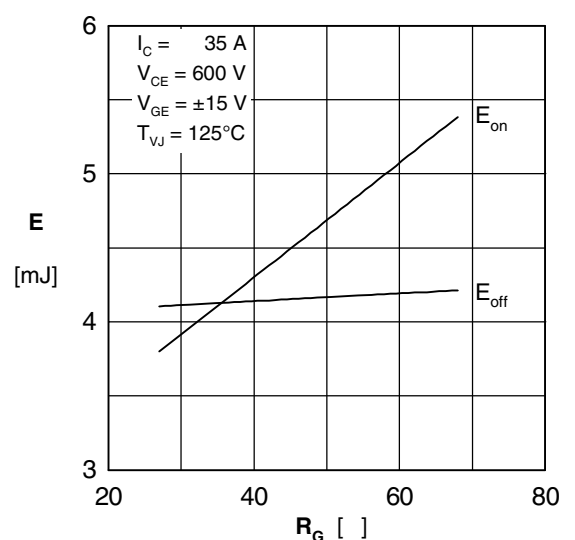

Fig. 6 Typ. switching energy vs. gate resistance

Diode

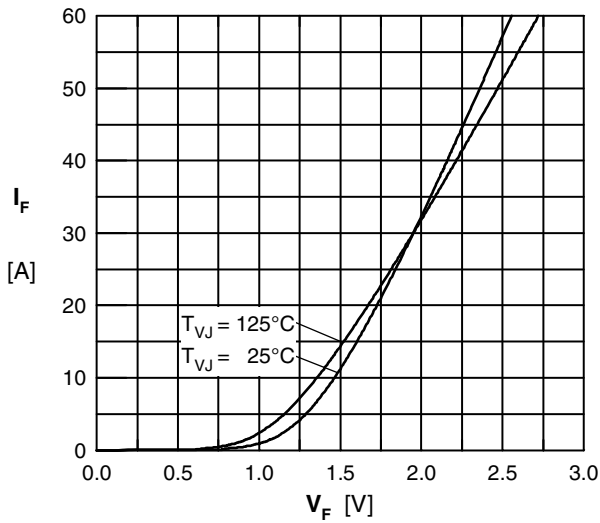

Fig. 7 Typ. Forward current versus V_F

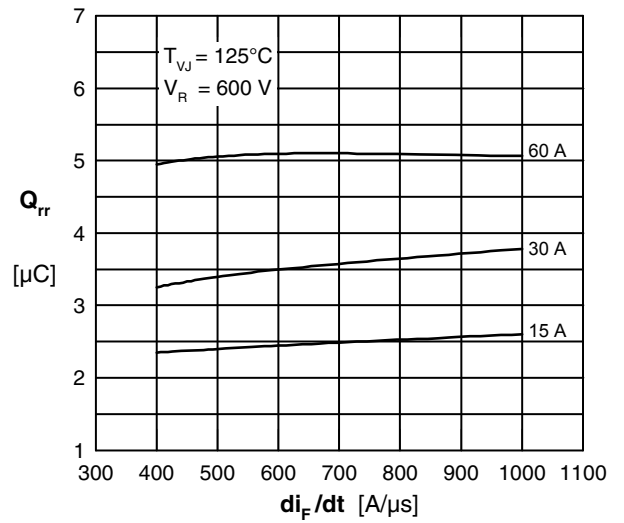

Fig. 8 Typ. reverse recov.charge Q_{rr} vs. di/dt

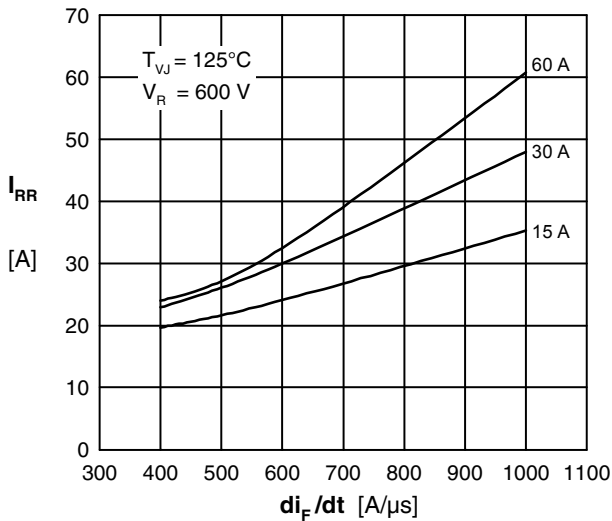

Fig. 9 Typ. peak reverse current I_{RM} vs. di/dt

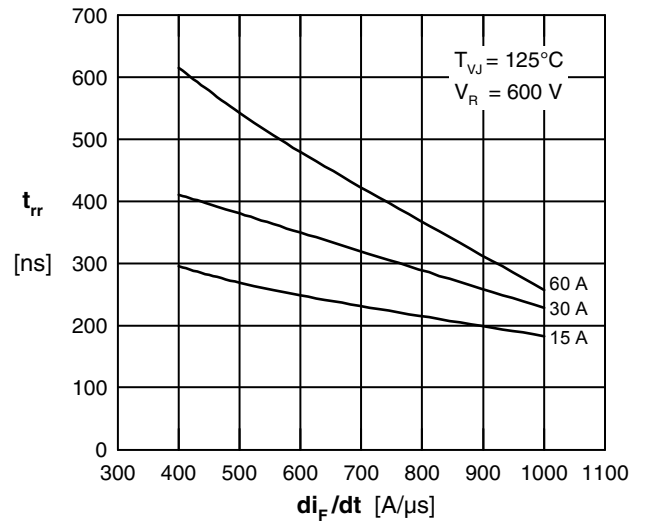

Fig. 10 Typ. recovery time t_{rr} versus di/dt

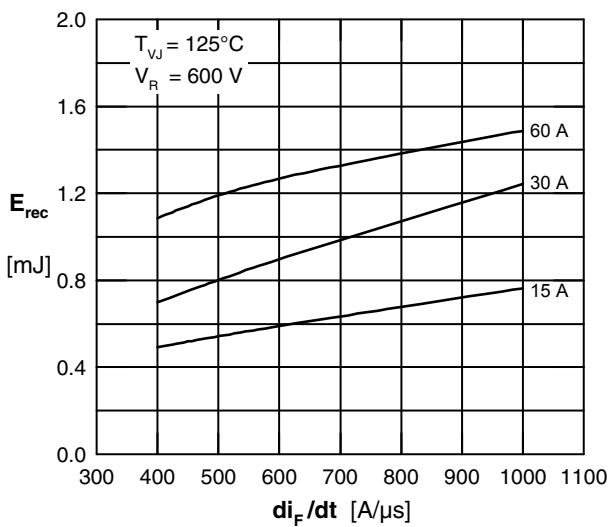

Fig. 5 Typ. recovery energy E_{rec} versus di/dt

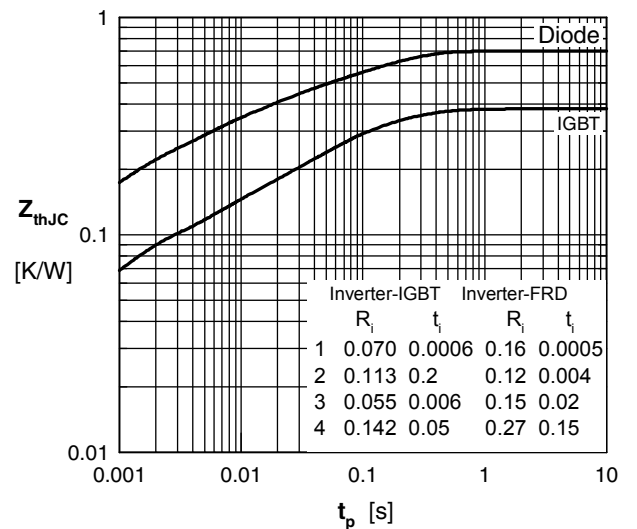

Fig. 12 Typ. transient thermal impedance