

Spezifikation für Freigabe / specification for release

Kunde / customer : _____
 Artikelnummer / part number : **7445710**
 Bezeichnung : **SMD-SPEICHERDROSSEL WE-PD 4**
 description : **POWER-CHOKE WE-PD 4**



DATUM / DATE : 2002-03-27

A Mechanische Abmessungen / dimensions:

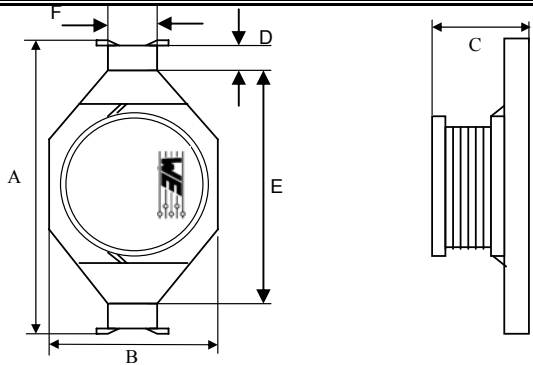

	Typ XL	
A	22,0 ± 0,3	mm
B	15,0 ± 0,3	mm
C	7,0 +0,8/-0,4	mm
D	2,3 (typ)	mm
E	15,0 (typ)	mm
F	8,0 (typ)	mm
G		mm
H		mm
I		mm

B Elektrische Eigenschaften / electrical properties:

Eigenschaften / properties	Testbedingungen / test conditions		Wert / value	Einheit / unit	tol.
Induktivität / inductance	100 kHz / 1V	L	10,00	μH	±20%
max. Strom / max. Current	ΔL/Lo= 10% max.	I _{sat}	10,00	A	max.
DC-Widerstand / DC-resistance		R _{DC}	17,2	mΩ	max.
Nennstrom / rated current	ΔT = +40°C	I _{DC}	6,50	A	max.
Eigenres.-Frequenz / self-res.-frequency		SRF		MHz	

C Lötpad / soldering spec.:

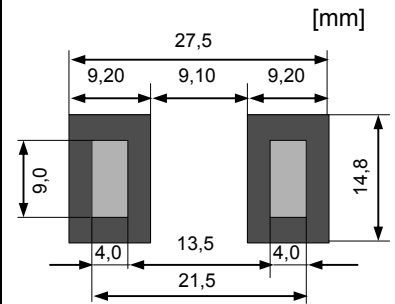

D Prüfgeräte / test equipment:

HP 4274 A für/for L und/and Q
HP 34401 A für/for I_{DC} und/and R_{DC}

E Testbedingungen / test conditions:

Luftfeuchtigkeit / humidity: 33%
 Umgebungstemperatur / temperature: +20°C

F Werkstoffe & Zulassungen / material & approvals

Basismaterial / base material: Ferrit/ferrite
 Draht / wire: 2 UEW; 130°C

G Eigenschaften / general specifications:

Lagertemperatur / storage temperature: -40°C - + 105°C
 Betriebstemp. / operating temperature: -40°C - +85°C

Freigabe erteilt / general release:	Kunde / customer				
Datum / date	Unterschrift / signature				
	Würth Elektronik		RT	Update	2003-01-20
			MST	Update	2002-03-27
AG.....		JH	Neugestaltung	2000-12-06
Geprüft / checked	Kontrolliert / approved		Name	Änderung / modification	Datum / date

Würth Elektronik eiSos GmbH & Co. KG