

Basic Characteristics Data

Model	Circuit method	Switching frequency [kHz]	Input current *1 [A]	Rated input fuse	Inrush current protection	PCB/Pattern			Series/Parallel operation availability	
						Material	Single sided	Double sided	Series operation	Parallel operation
LEB100F	Active filter	80	1.4	250V 5A	Thermistor	CEM-3	Yes		No	No
	Flyback converter	90 - 500								
	Forward converter	120								
LEB150F	Active filter	80	2.0	250V 6.3A	Thermistor	CEM-3	Yes		No	No
	Flyback converter	90 - 500								
	Forward converter	130								
LEB225F	Active filter	80	3.0	250V 8A	SCR	CEM-3	Yes		No	No
	Flyback converter	90 - 500								
	Forward converter	120								

*1 The value of input current is at ACIN 100V and rated load at LEB□F-0524.

1	Function	LEB-10
1.1	Input voltage range	LEB-10
1.2	Inrush current limiting	LEB-10
1.3	Overcurrent protection	LEB-10
1.4	Peakcurrent protection	LEB-10
1.5	Thermal protection	LEB-10
1.6	Overvoltage protection	LEB-10
1.7	Output voltage adjustment range	LEB-11
1.8	Isolation	LEB-11
2	Assembling and Installation Method	LEB-11
2.1	Installation method	LEB-11
2.2	Derating	LEB-11
2.3	Mounting screw	LEB-13
3	Ground	LEB-13
4	Peak loading	LEB-13
5	Option and others	LEB-13
5.1	Outline of option	LEB-13
5.2	Others	LEB-14

1 Function

1.1 Input voltage range

- The range is from AC85V to AC264V or DC120V to DC370V.
- In cases that conform with safety standard, input voltage range is AC100-AC240V(50/60Hz).
- AC input voltage must have a range from AC85V to AC264V for normal operation. If the wrong input is applied, the unit will not operate properly and/or may be damaged.

1.2 Inrush current limiting

- Inrush current limiting is built-in.
- If a switch on the input side is installed, it has to be the one handling the input inrush current.

●LEB100F · LEB150F

- The thermistor is used for protection from inrush current. When power is turned ON/OFF repeatedly within a short period of time, it is necessary to have enough time for power supply to cool down.

●LEB225F

- The thyristor technique is used for protection from inrush current. When power is turned ON/OFF repeatedly within a short period of time, it is necessary to have enough time between power ON and OFF to operate resistance circuit for inrush current.

1.3 Overcurrent protection

- Overcurrent protection is built-in and comes into effect at over 105% of the rated current in V1 and at over 101% of the peak current in V2. Overcurrent protection prevents the unit from short circuit and overcurrent condition.
- The unit automatically recovers when the fault condition is cleared.

●Foklbak characteristics (V1)

- The power supply witch has a current foklbak characteristics may not start up when connected to nonlinear load such as a lamp, motor constant current load. See the characteristics below.

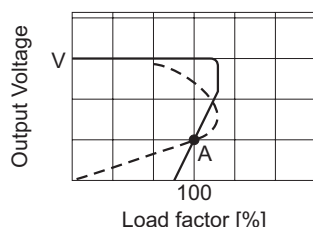

- : Load characteristics of power supply.
- - - -: Characteristics of load (lamp, motor, constant current load, etc.).
- Note: In case of nonlinear load, the output is locked out at A point.

●Intermittent current characteristics (V2)

- When the output voltage drops more than 50% of the rated output voltage value at overcurrent, the average output current is reduced by intermittent operation of power supply.

1.4 Peakcurrent protection (V2)

●LEB100F · LEB150F

- Peakcurrent protection is built-in (refer to Instruction Manual 4. for Peak loading).
- If this function comes into effect, the output V2 is shut down (but output V1 is not shut down).
- The minimum interval of AC recycling for recovery is 2 to 3 minutes (★).
- ★ The recovery time varies depending on input voltage and load condition.

1.5 Thermal protection (V2)

●LEB225F

- Thermal protection is built-in. If the power supply is operated under the following conditions, this function comes into effect and the output V2 is shut down (but output V1 is not shut down).
- ① Over rated temperature
- ② Poor ventilation
- ③ Over peak load based on Instruction Manual 4. for Peak loading
- If this function is in operation, turn off power, eliminate all possible causes of overheating, and drop the temperature to normal level.
- Output voltage recovers after applying input voltage.

1.6 Overvoltage protection

■Output V1

- Overvoltage protection circuit, clamping the output voltage by zener diode, is built-in and comes into effect at over 115% of the rated voltage. The unit in an overvoltage protection mode cannot be recovered by a user; it must be repaired at the factory.
- Overvoltage protection (diode) also comes into effect if the voltage is externally applied to the output side.
- Avoid applying voltage to the output side.

■Output V2

- Overvoltage protection is built-in and comes into effect at 115-140% of the rated voltage.
- The AC input should be shut down if overvoltage protection is in operation.
- The minimum interval of AC recycling for recovery is 2 to 3 minutes (★).
- ★ The recovery time varies depending on input voltage.

Remarks:

Please avoid applying the over-rated voltage to the output terminal. Power supply may operate incorrectly or fail. In case of operating a motor etc., please install an external diode on the output terminal to protect the unit.

Note:

Overvoltage protection is built-in each output. If overvoltage protection in V1 or V2 comes into effect, both of output V1 and V2 are not shut down. Each overvoltage protection is independent of each other.

1.7 Output voltage adjustment range

- Adjustment of output voltage is possible by using potentiometer (only available V1 output).
- Output voltage is increased by turning potentiometer clockwise and is decreased by turning potentiometer counterclockwise.

1.8 Isolation

- For a receiving inspection, such as Hi-Pot test gradually increase (decrease) the voltage for the start (shut down). Avoid using Hi-Pot tester with the timer because it may generate voltage a few times higher than the applied voltage, at ON/OFF of a timer.
- If the unit is tested on the isolation between input & output and output & FG, remote ON/OFF (option) must be shorted to outputs.

2 Assembling and Installation Method

2.1 Installation method

- When two or more power supplies are used side by side, position them with proper intervals to allow enough air ventilation. Ambient temperature around each power supply should not exceed the temperature range shown in derating curve.
- In case of metal chassis, keep the distance between d1 and d2 for to insulate between lead of component and metal chassis. If it is less than d1 and d2, insert the insulation sheet between power supply and metal chassis.

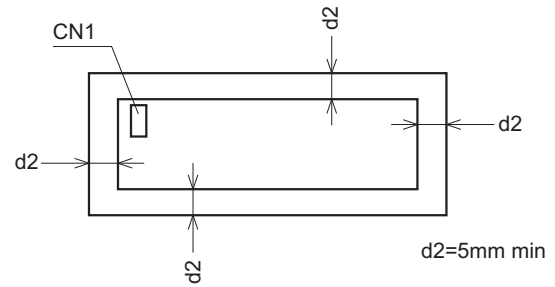
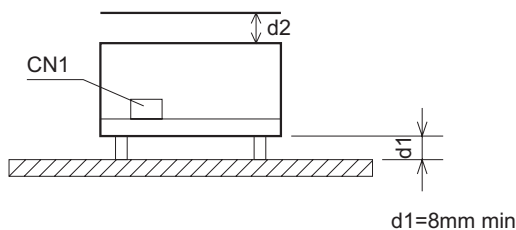

LEB

2.2 Derating

- In the hatched area the specification of Ripple, Ripple Noise is different from other area.
- In case②, ventilation must keep the temperature of C119 below 85°C. See External View for the location of C119.
- The operative ambient temperature is different by with/without case cover or mounting position. Please refer to drawings as below.
- ★ Please be careful of electric shock or earth leakage in case of temperature measurement, because C119 is live potential.

●LEB100F

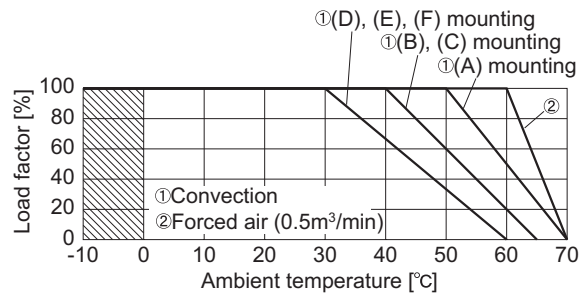

●LEB100F-□-SN (requirement: Min. AC90V)

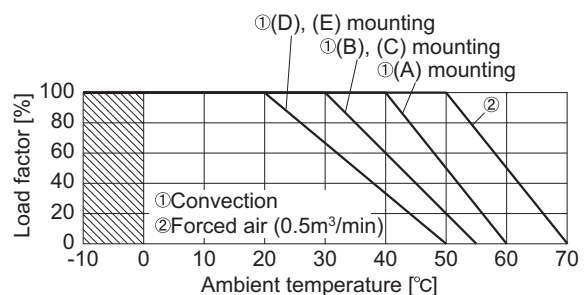

●LEB150F

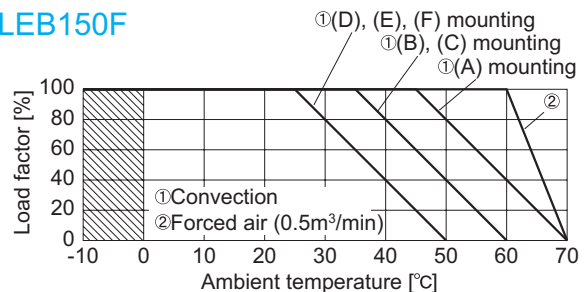

●LEB150F-□-SN (requirement: Min. AC90V)

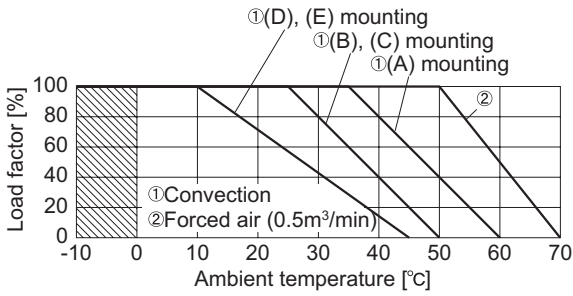

●LEB225F

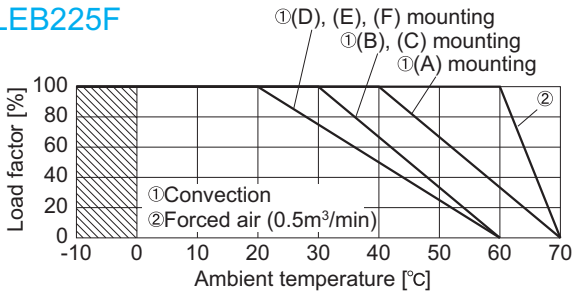

●LEB225F-□-SN (requirement: Min. AC90V)

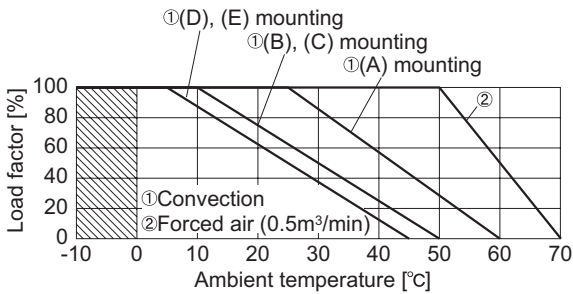

■Option "-SN" is easy to be full of heat air inside power supply. The ventilation design with derating or forced air is recommended.

■When unit mounted except below drawings, it is required to consider ventilated environment by forced air cooling for temperature / load derating. For details, please consult our sales or engineering departments.

■(F) mounting is not possible when unit is with case cover, but if need to operate unit by (F) positioning with case cover, temperature / load derating is necessary. For more details, please consult our sales or engineering department.

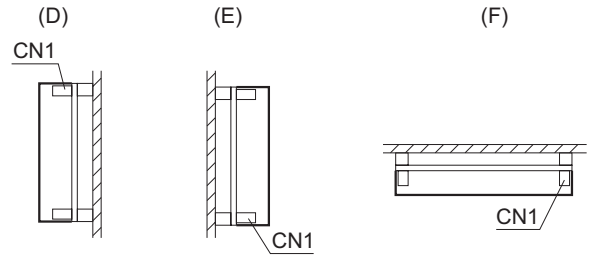
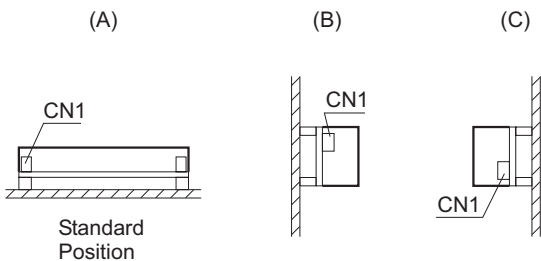

■Definition of load factor

$$A1=I_{o1}/I_1 \times 100 \quad A2=I_{o2}/I_2 \times 100$$

$$A3= (V_1 \times I_{o1} + V_2 \times I_{o2}) / (\text{TOTAL OUTPUT WATTAGE}) \times 100$$

where:

V₁:VOLTAGE OF OUTPUT V₁, I_{o1}:CURRENT OF OUTPUT V₁, I₁: RATED CURRENT OF OUTPUT V₁

V₂:VOLTAGE OF OUTPUT V₂, I_{o2}:CURRENT OF OUTPUT V₂, I₂:RATED CURRENT OF OUTPUT V₂

NOTE:

Refer to SPECIFICATION for TOTAL OUTPUT WATTAGE and OTHERS

Load factor[%]=Maximum value in A₁, A₂, A₃

[ex.1] The method which seeks for the upper limit of ambient temperature in LEB100F-0524 as following conditions,
Load condition:V₁=5V, I_{o1}=0.2A V₂=24V, I_{o2}=2A
Installation: standard position and conventional cooling

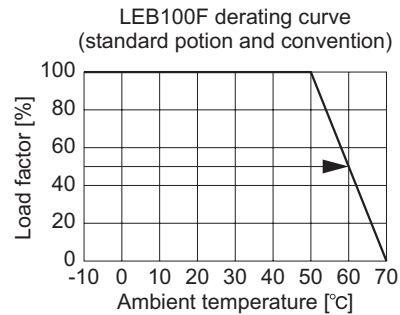

Calculating A₁, A₂, A₃

$$A1=I_{o1}/I_1 \times 100=0.2/5 \times 100=4$$

$$A2=I_{o2}/I_2 \times 100 = 2/4 \times 100 = 50$$

$$A3=(V_1 \times I_{o1} + V_2 \times I_{o2}) / (\text{TOTAL OUTPUT WATTAGE}) \times 100 = (5 \times 0.2 + 24 \times 2) / 100 \times 100 = 49$$

Accordingly load factor is 50[%] which is maximum value in A₁, A₂, A₃ and the upper limit of ambient temperature is 60°C by derating curve.

[ex.2] The method which seeks for the upper limit of V₂ output current as I₂ in LEB100F-0524 as following conditions,
 Load condition: V₁=5V, I₁=4A V₂=24V
 Ambient temperature: 50°C
 Installation: standard potion and conventional cooling

Load factor is 100[%] at ambient temperature=50°C by de-rating curve, In this case the value of each A₁, A₂, A₃ is required less than 100[%].

$$100 \geq A_1 = I_{o1}/I_1 \times 100 \quad 100 \geq A_2 = I_{o2}/I_2 \times 100$$

$$100 \geq A_3 = (V_1 \times I_{o1} + V_2 \times I_{o2}) / (\text{TOTAL OUTPUT WATTAGE}) \times 100$$

$$100 \geq 4/5 \times 100 \quad 100 \geq I_{o2}/4 \times 100$$

$$100 \geq (5 \times 4 + 24 \times I_{o2}) / 100 \times 100$$

according I_{o2} ≤ 3.3A and as a result the upper limit of V₂ output current as I₂ is less than 3.3A.

2.3 Mounting screw

- The mounting screw should be M3. The hatched area shows the allowance of metal parts for mounting.
- Please be carefull with that metal parts do not touch mounted parts at front side, where major components are mounted, when a power supply is installed with them.
- Keep isolation distance between screw and internal components in case of option "-S", "-SN" as below chart.

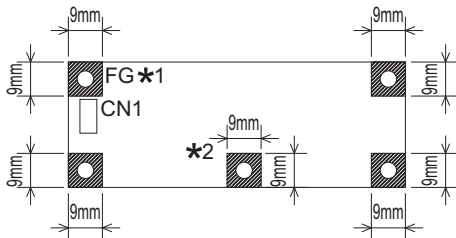

- *1 Recommendation to electrically connect FG to metal chassis for reducing noise.
- *2 LEB150F and LEB225F only
Refer to External view for location

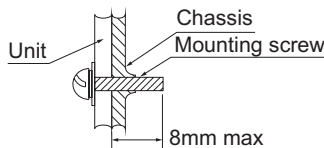

3 Ground

- When installing the power supply with your unit, ensure that the input FG terminal of CN1 or mounting hole FG is connected to safety ground of the unit.
- However when applying the safety agency, connect the input FG terminal of CN1 to safety ground of the unit.



LEB

4 Peak loading

- Peak load (V₂) is possible to draw as below.

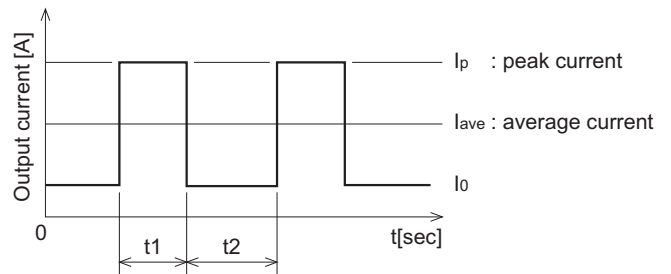

$$t_1 \leq 10 \text{ [sec]}, I_{ave} = \frac{I_p t_1 + I_o t_2}{t_1 + t_2} \leq \text{rated current}, \frac{t_1}{t_1 + t_2} \leq 0.35$$

5 Option and others

5.1 Outline of option

●-G

- Option "-G" means leakage current is smaller than standard model by reducing the value of earth capacitor at input filter circuit.

Leakage current	0.1mA max
Conducted noise	Not available

●-R

- Option "-R" means output remote ON/OFF (V2) is made possible.
 - ★ Remote ON/OFF circuit (RC(+), RC(-)) is isolated from input and FG but not isolated from output V1.
- Please consult our sales or engineering departments in other application.
- A wrong connection may damage the internal components of the unit.

Between RC (+) and RC (-)	Output (V2)
SW ON (0 - 0.5V)	ON
SW OFF (at shipping) (4.5 - 5.5V)	OFF

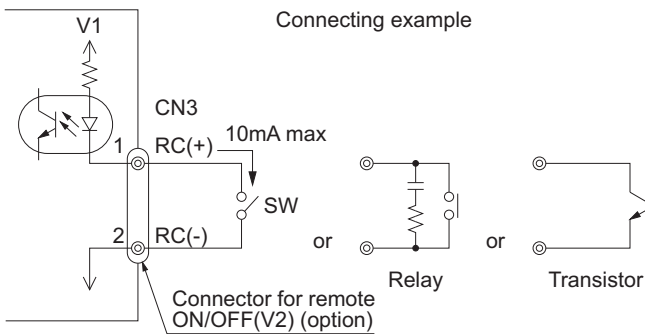

●-S · -SN

- Option "-S" means chassis is attached to standard model.
- Option "-SN" means chassis and cover is attached to standard model. Refer to 2.2 Derating for derating curve.

●-T

- Option "-T" means input and output interface are changed "Connector" to "Terminal block".



●-Z □

- Option "-Z □" means ZT3 series in COSEL is mounted on standard model.
- Refer to external view for output terminal.
- Refer to COSEL catalog about ZT specification in detail.
- It is possible to select ZT as below chart.

Optional symbol	-Z31	-Z32	-Z33	-Z34	-Z35
Mounted Power supply	ZTS3 2405	ZTS3 2412	ZTS3 2415	ZTW3 2412	ZTW3 2415
Notice	V2=24[V], 30[V], 36[V] model				
Optional symbol	-Z21	-Z22	-Z23	-Z24	-Z25
Mounted Power supply	ZTS3 1205	ZTS3 1212	ZTS3 1215	ZTW3 1212	ZTW3 1215
Notice	V2=12[V] model				

5.2 Others

- This power supply is the rugged PCB type. Do not drop conductive objects in the power supply.
- At light load, there remains high voltage inside the power supply for a few minutes after power OFF.
 - So, at maintenance, take care about electric shock.
- This power supply is manufactured by SMD technology. The stress to PCB like twisting or bending causes the defect of the unit, so handle the unit with care.