

K1F003MLH

cam ammeter switch - 3 circuits - 90° - 12 A - screw mounting



Main

Range of product	Harmony K
Product or component type	Complete cam switch
Component name	K1
[Ith] conventional free air thermal current	12 A
Product mounting	Front mounting
Fixing mode	Multifixing
Cam switch head type	With front plate 45 x 45 mm
Type of operator	Black handle, length = 35 mm
Rotary handle padlocking	Without
Presentation of legend	With metallic legend, 0 - L1 - L2 - L3 black marking
Cam switch function	Ammeter switch
Return	Without
Type of measurement	For 3 circuits
Off position	With Off position
Switching positions	Right: 0° - 90° - 180° - 270°
IP degree of protection	IP40 conforming to IEC 529 IP40 conforming to NF C 20-010

Complementary

Switching angle	90 °
[Ui] rated insulation voltage	690 V degree of pollution 3 conforming to IEC 60947-1
[Ithe] conventional enclosed thermal current	10 A
Rated operational power in W	1500 W AC-3 / 500 V 3 phases conforming to IEC 60947-3 10500 W AC-21 / 500...660 V 3 phases conforming to IEC 60947-3 1500 W AC-3 / 400 V 1 phase conforming to IEC 60947-3 2200 W AC-23A / 690 V 3 phases conforming to IEC 60947-3 1500 W AC-23A / 230 V 3 phases conforming to IEC 60947-3 2200 W AC-23A / 500 V 3 phases conforming to IEC 60947-3 2200 W AC-23A / 400 V 3 phases conforming to IEC 60947-3 4800 W AC-21 / 230 V 3 phases conforming to IEC 60947-3 1100 W AC-3 / 230 V 3 phases conforming to IEC 60947-3 600 W AC-3 / 230 V 1 phase conforming to IEC 60947-3 1500 W AC-3 / 400 V 3 phases conforming to IEC 60947-3 8300 W AC-21 / 400 V 3 phases conforming to IEC 60947-3 1500 W AC-3 / 690 V 3 phases conforming to IEC 60947-3
[Ie] rated operational current AC	1 A at 500 V AC-15 conforming to IEC 60947-5-1 2 A at 400 V AC-15 conforming to IEC 60947-5-1 3 A at 230 V AC-15 conforming to IEC 60947-5-1 1.8 A at 690 V AC-3 3 phases conforming to IEC 60947-3 2.8 A at 500 V AC-3 3 phases conforming to IEC 60947-3 2.8 A at 690 V AC-23A 3 phases conforming to IEC 60947-3 3.3 A at 400 V AC-3 3 phases conforming to IEC 60947-3 3.8 A at 500 V AC-23A 3 phases conforming to IEC 60947-3 4.6 A at 230 V AC-3 3 phases conforming to IEC 60947-3 4.8 A at 400 V AC-23A 3 phases conforming to IEC 60947-3 5.6 A at 230 V AC-23A 3 phases conforming to IEC 60947-3
Electrical durability	1000000 cycles AC-15 1000000 cycles AC-21 500000 cycles AC-23 500000 cycles AC-3
Operating rate	2.5 cyc/mn AC-21 2.5 cyc/mn AC-23 2.5 cyc/mn AC-3 8.333 cyc/mn AC-15
Short-circuit current	10000 A

The information provided in this documentation contains general descriptions and/or technical characteristics of the products contained herein. This documentation is not intended as a substitute for and is not to be used for determining suitability or reliability of these products for specific user applications. It is the duty of any such user or integrator to perform the appropriate and complete risk analysis, evaluation and testing of the products with respect to the relevant specific application or use thereof. Neither Schneider Electric Industries SAS nor any of its affiliates or subsidiaries shall be responsible or liable for misuse of the information contained herein.

Short circuit protection	16 A by cartridge fuse, type gG
[Uimp] rated impulse withstand voltage	4 kV in isolating function 6 kV conforming to IEC 60947-1
Contacts operation	Slow-break
Positive opening	With
Electrical connection	Captive screw clamp terminals flexible, 2 x 1.5 mm ² Captive screw clamp terminals solid, 1 x 2.5 mm ²
Mechanical durability	1000000 cycles
CAD overall width	45 mm
CAD overall height	45 mm
CAD overall depth	97 mm
Product weight	0.17 kg

Environment

standards	CENELEC EN 50013 EN/IEC 60947-3 for power circuit EN/IEC 60947-5-1 for control circuit
product certifications	CSA 240 V 1 hp 1 phase CSA 240 V 3 hp 3 phases 2 -pole(s) UL 240 V 1 hp 3 phases UL 240 V 0.33 hp 1 phase 2 -pole(s)
protective treatment	TC
ambient air temperature for operation	-25...55 °C
ambient air temperature for storage	-40...70 °C
shock resistance	30 gn conforming to IEC 68-2-27
vibration resistance	5 gn, 10...150 Hz conforming to IEC 68-2-6
class of protection against electric shock	Class II conforming to IEC 536 Class II conforming to NF C 20-030

Contractual warranty

Warranty period	18 months
-----------------	-----------

Operating Head and Body

Front Mounting "Multi-Fixing"

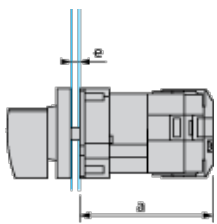

a 73 mm/2.87 in.

e support panel thickness 1 mm to 6 mm./0.039 in. to 0.24 in.

Link Positions (Factory Mounted)

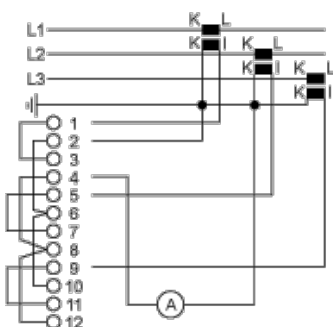

Marking

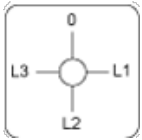





Angular Position of Switch

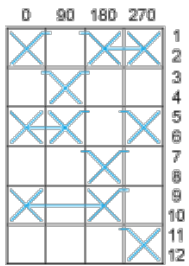

Switching Program



Convention Used for Switching Program Representation

-  Contact closed
-  Contact closed in 2 positions and maintained between the 2 positions
-  Sealed assembly for auto-maintain control
-  Overlapping contacts
-  Spring return position: for a switching angle of 90°, spring return is over 30° after the last position (for a maximum of 3 simultaneous contacts).

Example:

