

Angle grippers DHWS

FESTO



Key features

At a glance

General information

- Improved gripper jaw guide
- Slotted guide
- Max. repetition accuracy
- Gripping force retention
- Internal fixed flow control
- Wide range of adaptation options on the drives

- Sensor technology:
 - Adaptable position sensor for the small gripper sizes
 - Integrated proximity sensors for the medium and large gripper sizes

Flexible range of applications

- Can be used as a double-acting and single-acting gripper
- Compression spring for supplementing or retaining the gripping forces
- Suitable for external and internal gripping

The technology in detail

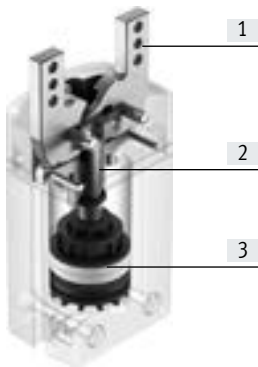

- [1] Gripper jaws
- [2] Link
- [3] Piston with magnet

Note

Engineering software for gripper selection
 → www.festo.com

Position sensing/force control

With position transmitter SMAT-8M/SDAT



- Analogue position feedback possible
- Analogue output
 - 0 ... 10 V
 - 4 ... 20 mA

With proportional pressure regulator VPPM



- Infinite adjustment of the gripping force possible
- Setpoint input
 - 0 ... 10 V
 - 4 ... 20 mA

With proximity sensor SMT-8G/-10G



- Detecting multiple positions:
- Open
 - Closed
 - Workpiece gripped

Key features

Supply ports

From the side

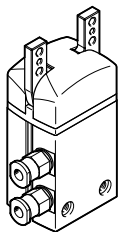

Mounting options

From the side

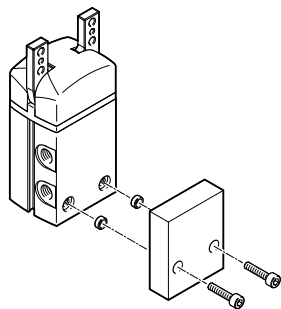
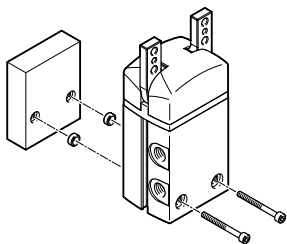

From underneath

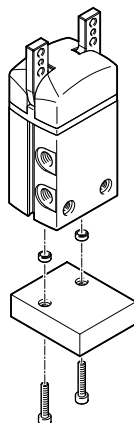

Mounting options for external gripper fingers

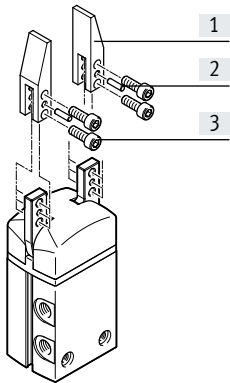

- [1] Gripper fingers
- [2] Centring pins
- [3] Retaining screws

Note

Angle grippers are not designed for the following application examples:

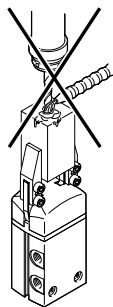

- Machining
- Aggressive media

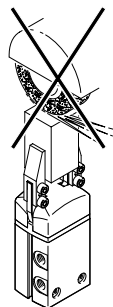

- Grinding dust

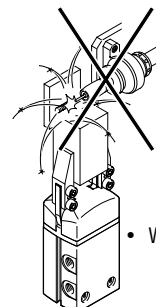

- Welding spatter

Peripherals overview

Peripherals overview

DHWS-10

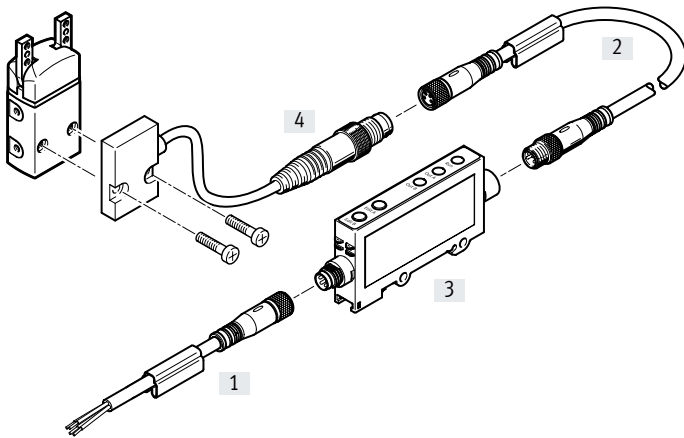

DHWS-16 ... 40

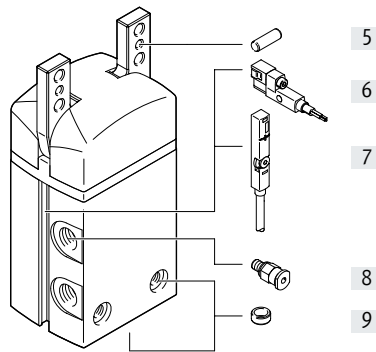

System product for handling and assembly technology

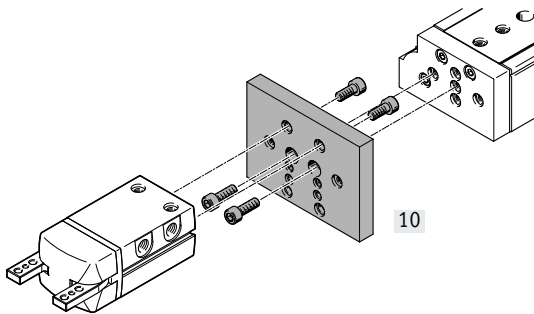

Proportional-pressure regulator VPPM

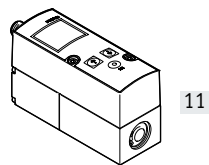

Peripherals overview

Accessories				
	Type	For size	Description	→ Page/Internet
[1]	Connecting cable NEBU	10	<ul style="list-style-type: none"> • Connection between signal converter and controller 	19
[2]	Connecting cable NEBU	10	<ul style="list-style-type: none"> • Connection between position sensor and signal converter 	19
[3]	Signal converter SVE4	10	<ul style="list-style-type: none"> • For evaluating signals for position sensor SMH-S1 	19
[4]	Position sensor SMH-S1	10	<ul style="list-style-type: none"> • Adaptable and integratable sensor technology for sensing the piston position 	19
[5]	Centring pin	10 ... 40	<ul style="list-style-type: none"> • For centring the gripper fingers on the gripper jaws 	–
[6]	Proximity sensor SMT-8G	16 ... 40	<ul style="list-style-type: none"> • For sensing the piston position • Proximity sensor does not project past the housing at the bottom 	20
[7]	Position transmitter SMAT-8M	16 ... 40	<ul style="list-style-type: none"> • Continuously senses the position of the piston. It has an analogue output with an output signal relative to the piston position. 	20
	Position transmitter SDAT	32, 40		
[8]	Push-in fitting QS	10 ... 40	<ul style="list-style-type: none"> • For connecting compressed air tubing with standard O.D. 	qs
[9]	Centring sleeve ZBH	10 ... 40	<ul style="list-style-type: none"> • For centring the gripper during mounting • 2 centring sleeves included in the scope of delivery of the gripper 	19
[10]	Adapter kit DHAA, HMSV, HAPG, HAPS, HMVA	10 ... 40	<ul style="list-style-type: none"> • Connecting plate between drive and gripper 	17
[11]	Proportional-pressure regulator VPPM	10 ... 40	<ul style="list-style-type: none"> • For infinite adjustment of the gripping force 	vppm

Type codes

001	Series
DHWS	Angle gripper

002	Size
10	10
16	16
25	25
32	32
40	40

003	Position sensing
A	For proximity sensor

004	Gripping force backup
	None
NC	N/O contact

Data sheet

-  Size
10 ... 40 mm
-  Opening angle
40°
-  www.festo.com

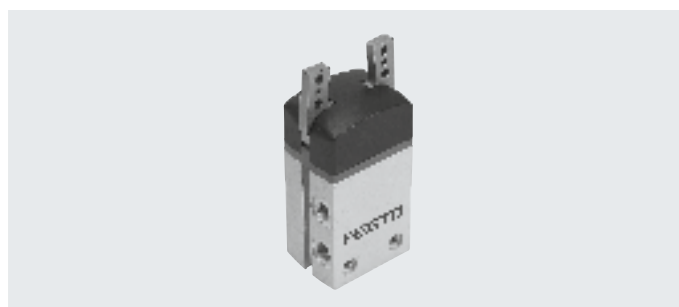
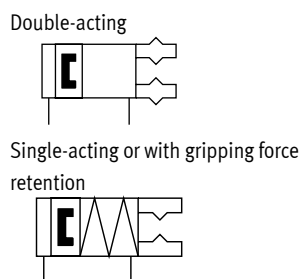

General technical data		10	16	25	32	40
Size		10	16	25	32	40
Design		Lever				
Mode of operation		Double-acting				
Gripper function		Angular				
Guide		Plain-bearing guide				
Gripping force retention		–	NC	NC	NC	NC
Number of gripper jaws		2				
Opening angle per gripper jaw	[°]	20				
Pneumatic connection		M3	M3	M5	G1/8	G1/8
Repetition accuracy ¹⁾	[mm]	≤ 0.04				
Max. interchangeability	[mm]	≤ ±0.2				
Max. operating frequency	[Hz]	4			3	
Rotational symmetry	[mm]	< ∅ 0.2				
Position sensing		Via position sensor		Via proximity sensor, position transmitter		
Type of mounting		Via through-hole and centring sleeve				
		Via female thread and centring sleeve				
Mounting position		Any				

1) Under constant exposure to operating conditions, end-position drift occurs in the direction of movement of the gripper jaws, at 100 consecutive strokes

Operating and environmental conditions		10	16	25	32	40
Size		10	16	25	32	40
Min. operating pressure						
DHWS-...-A	[bar]	2				
DHWS-...-A-NC	[bar]	–	4			
Max. operating pressure	[bar]	8				
Operating medium		Compressed air to ISO 8573-1:2010 [7:4:4]				
Note on operating/pilot medium		Lubricated operation possible (in which case lubricated operation will always be required)				
Ambient temperature ¹⁾	[°C]	+5 ... +60				
Corrosion resistance class CRC ²⁾		1				

1) Note operating range of proximity sensors

2) Corrosion resistance class CRC 1 to Festo standard FN 940070

Low corrosion stress. Dry indoor application or transport and storage protection. Also applies to parts behind coverings, in the non-visible interior area, and parts which are covered in the application (e.g. drive trunnions).

Weight [g]		10	16	25	32	40
Size		10	16	25	32	40
DHWS-...-A		40	110	258	452	775
DHWS-...-A-NC		–	114	265	462	790

Data sheet

Materials

Sectional view

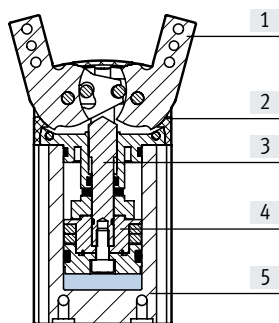

Angle gripper	
[1] Gripper jaws	High-alloy stainless steel
[2] Cover cap	Polyamide
[3] Link	Tempered steel
[4] Piston	Polyacetal
[5] Housing	Hard anodised wrought aluminium alloy
- Seals	Nitrile rubber
- Note on materials	Free of copper and PTFE
	RoHS-compliant

Total gripping torque [Ncm] at 6 bar

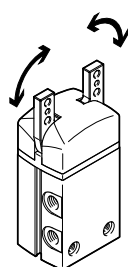

Size		10	16	25	32	40
DHWS-...-A	Opening	43	129	386	810	1497
	Closing	30	114	356	746	1362

Static characteristic load values at the gripper jaws

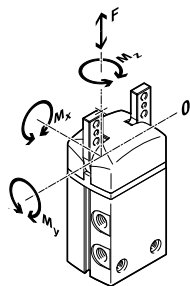

The indicated permissible forces and torques apply to a single gripper jaw. They include the lever arm, additional weight forces created by the workpiece or external gripper fingers and acceleration forces during movement. The zero coordinate line (gripper jaw guide) must be taken into consideration when calculating torques.

Size		10	16	25	32	40
Max. permissible force F_z	[N]	25	50	90	120	200
Max. permissible torque M_x	[Nm]	0.6	1.6	3.6	6	13
Max. permissible torque M_y	[Nm]	0.6	1.6	3.6	6	13
Max. permissible torque M_z	[Nm]	0.6	1.6	3.6	6	13

Mass moments of inertia [$\text{kgm}^2 \times 10^{-4}$]

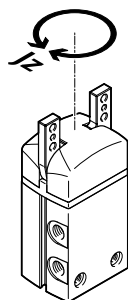

Mass moment of inertia of the angle gripper in relation to the central axis, without external gripper fingers, without load.

Size		10	16	25	32	40
DHWS-...-A		0.03	0.14	0.62	1.60	3.81
DHWS-...-A-NC		-	0.15	0.64	1.63	3.87

Data sheet

Opening and closing times [ms] at 6 bar

Without external gripper fingers

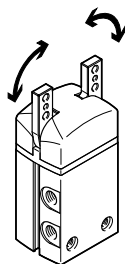

The indicated opening and closing times [ms] were measured at room temperature at an operating pressure of 6 bar with the gripper horizontally mounted and without additional gripper fingers (mean values shown). The grippers must be throttled for greater applied loads. Opening and closing times must then be adjusted accordingly.

Size		10	16	25	32	40
Without external gripper fingers						
DHWS-...-A	Opening	10	44	64	46	63
	Closing	22	52	80	77	96
DHWS-...-A-NC	Opening	-	62	106	88	99
	Closing	-	36	59	55	69

Opening and closing times t to be set at 6 bar as a function of mass moment of inertia of the gripper fingers

DHWS-10

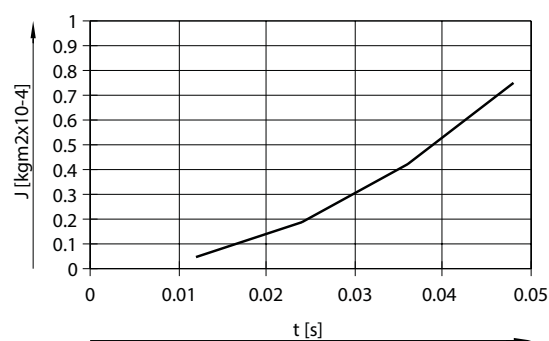

DHWS-16

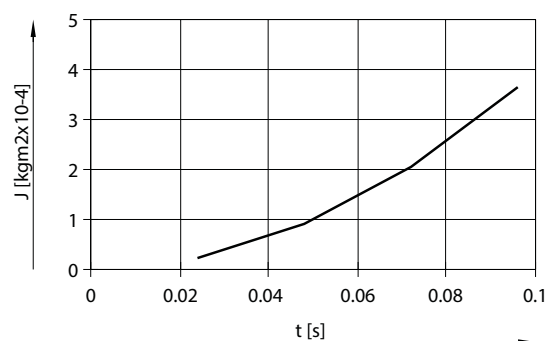

DHWS-25

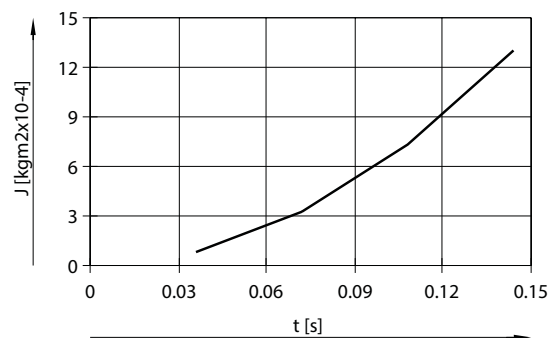

DHWS-32

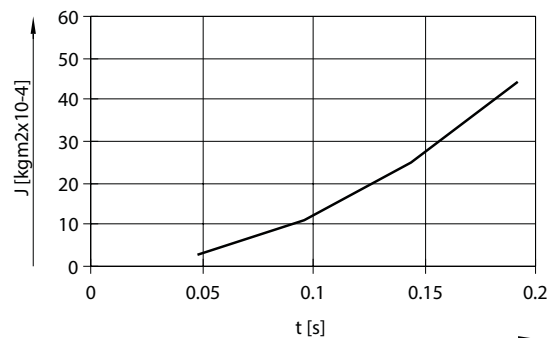

DHWS-40

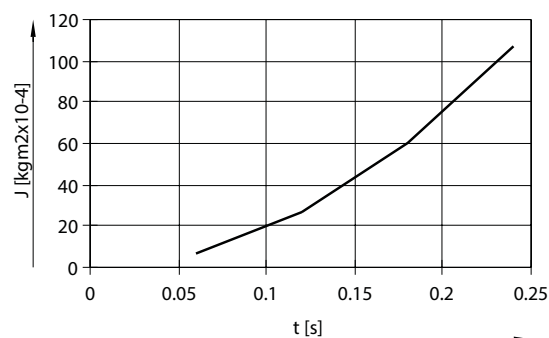

Data sheet

Gripping force F_H per gripper jaw as a function of operating pressure and lever arm x

The gripping forces as a function of the operating pressure and lever arm can be determined from the following graphs.

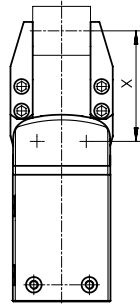

Note
Engineering software
for gripper selection
→ www.festo.com

- 2 bar
- · - · - 4 bar
- - - - 6 bar
- · · · · 8 bar

External gripping (closing)

DHWS-10

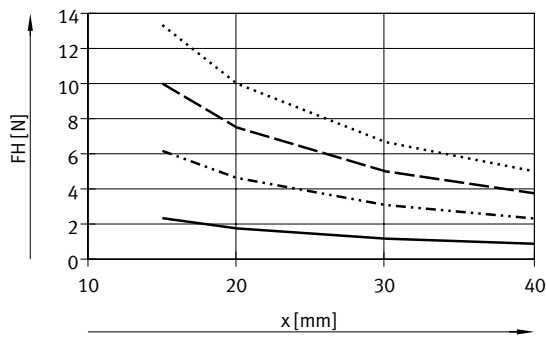

DHWS-16

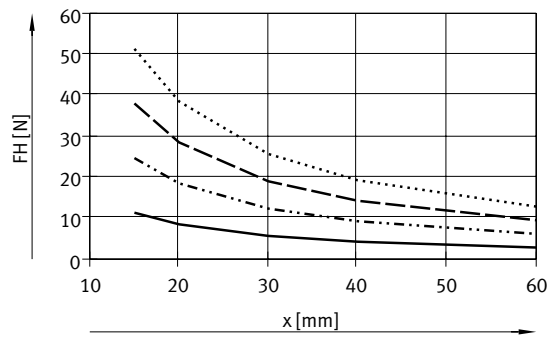

DHWS-25

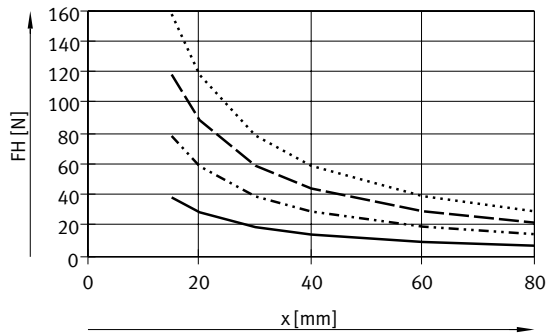

DHWS-32

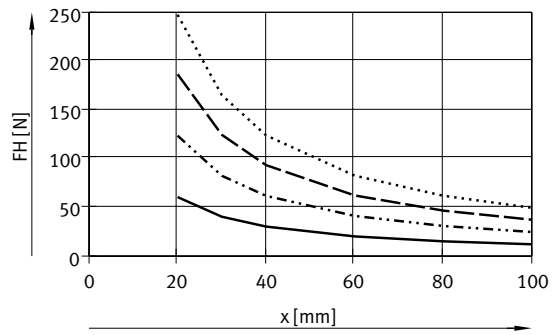

DHWS-40

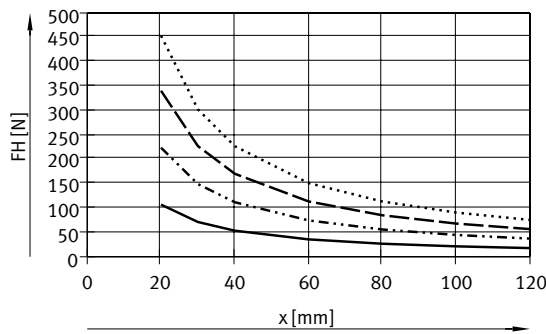

Data sheet

Gripping force F_H per gripper jaw as a function of operating pressure and lever arm x

The gripping forces as a function of the operating pressure and lever arm can be determined from the following graphs.

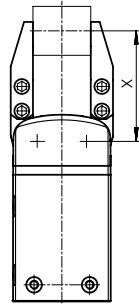

 **Note**
Engineering software
for gripper selection
→ www.festo.com

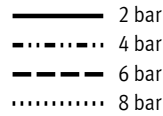

Internal gripping (opening)

DHWS-10

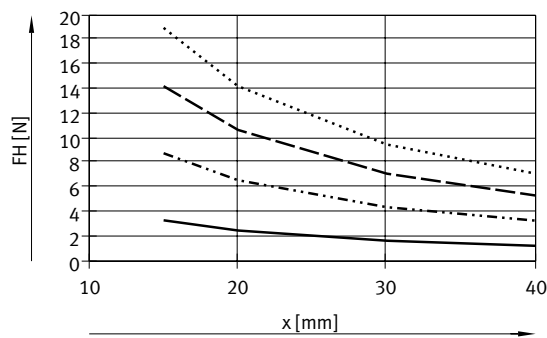

DHWS-16

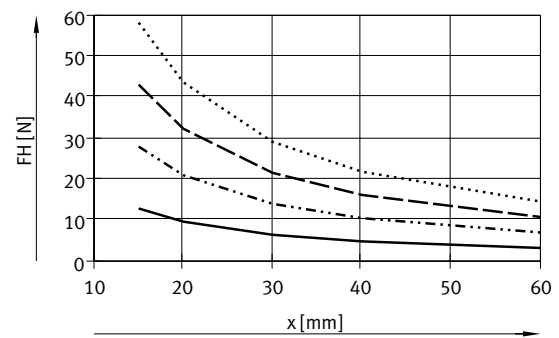

DHWS-25

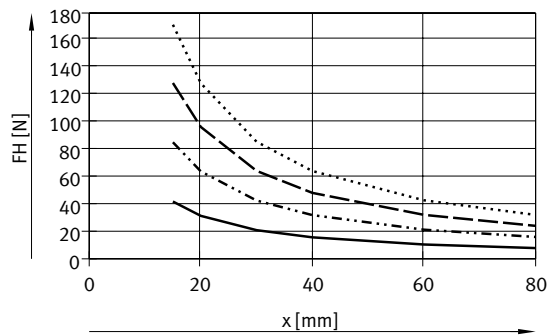

DHWS-32

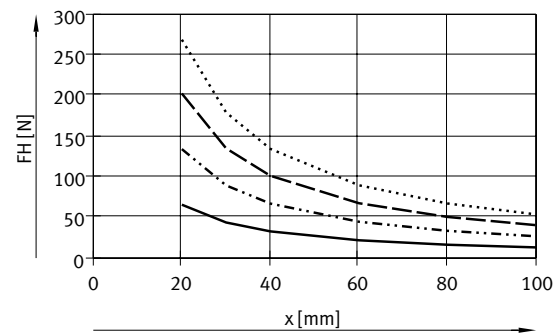

DHWS-40

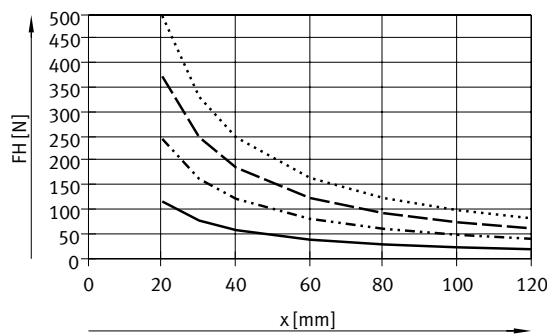

Data sheet

Gripping force F_H per gripper jaw at 6 bar as a function of lever arm x and eccentricity a and b

The following formula must be used to calculate the lever arm x with eccentric gripping:

$$x = \sqrt{a^2 + b^2}$$

The gripping force F_H can be read from the graphs (→ page 10) using the calculated value x .

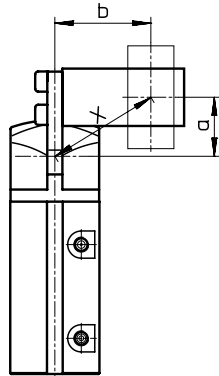

Calculation example

Given:

Distance $a = 20$ mm

Distance $b = 25$ mm

To be calculated:

The gripping force at 6 bar

with a DHWS-16,

used as an external gripper

Procedure: calculating the lever arm x

$$x = \sqrt{20^2 + 25^2}$$

$$x = 32$$
 mm

The graph (→ page 10) gives a value of $F_H = 18$ N for the gripping force.

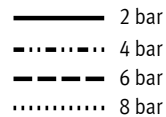
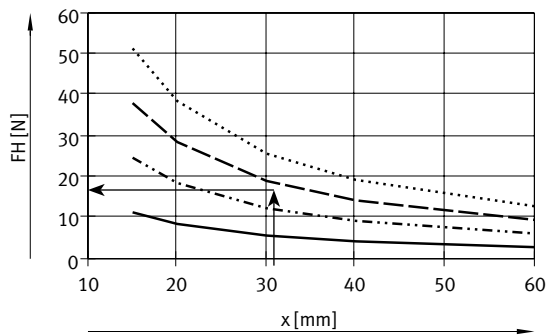

Data sheet

Spring torque M_F as a function of opening angle α

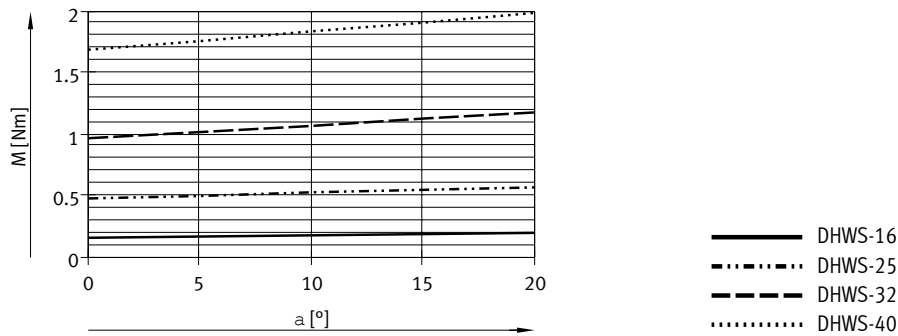

Determining the actual gripping torques $M_{Grtotal}$ for DHWS-...-NC as a function of application

The angle gripper with integrated spring type DHWS-...-NC (closing gripping force retention) can be used as:

- Single-acting gripper
- Gripper with supplementary gripping force
- Gripper with gripping force retention

To calculate the available gripping torque $M_{Grtotal}$ (per gripper jaw), the data from the graphs for the gripping force F_H (→ page 10) and the spring torque M_F (→ page 13) must be combined accordingly.

$$M_{Gr} = F_H \cdot x$$

M_{Gr} Gripping torque
 F_H Gripping force
 x Lever arm

Application

Single-acting	Supplementary gripping force	Gripping force retention
<ul style="list-style-type: none"> • Gripping with spring force: $M_{Grtotal} = M_F$ • Gripping with pressure force: $M_{Grtotal} = M_{Gr} - M_F$ 	<ul style="list-style-type: none"> • Gripping with pressure and spring force: $M_{Grtotal} = M_{Gr} + M_F$ 	<ul style="list-style-type: none"> • Gripping with spring force: $M_{Grtotal} = M_F$

Data sheet

Dimensions

Download CAD data → www.festo.com

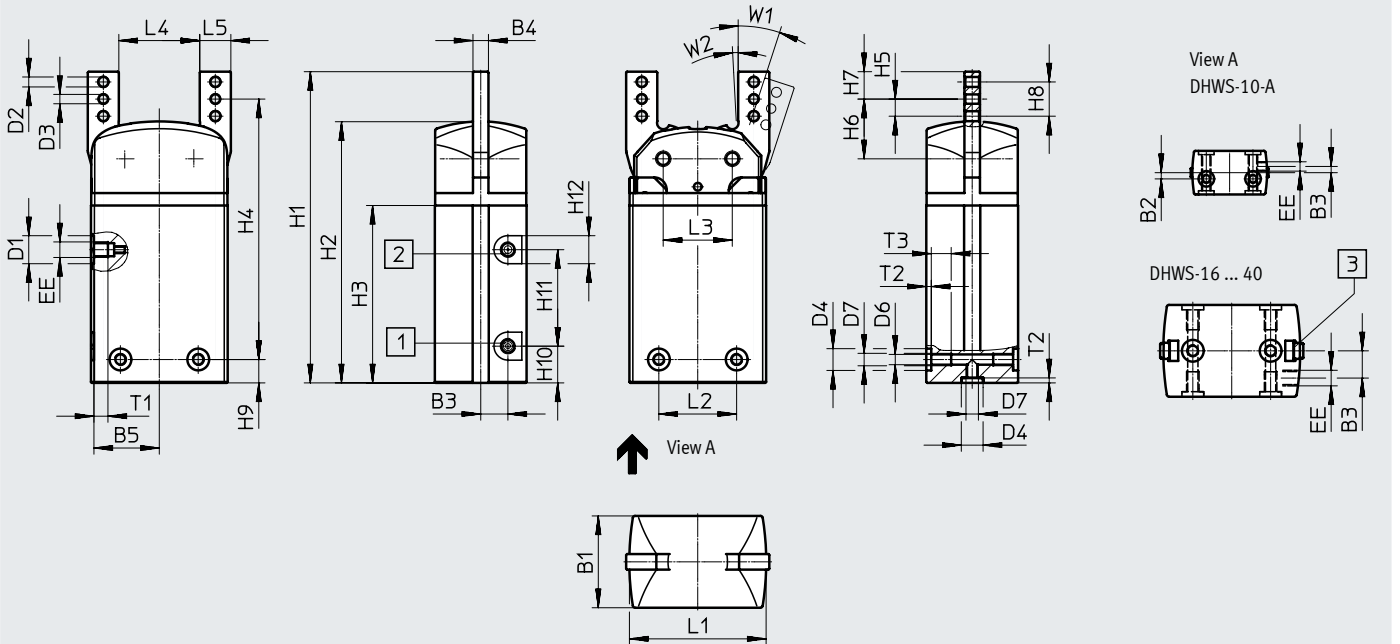

- [1] Supply port, opening
- [2] Supply port, closing
- [3] Slot for proximity sensor
- [7] Mounting interface: centring sleeves ZBH for mounting the gripper (2 included in the scope of delivery)

Size	B1	B2 ¹⁾	B3	B4 -0.03/ -0.05	B5	D1 ∅	D2 ∅ ±0.1	D3 ∅ H8	D4 ∅ H8/h7	D6 ∅ +0.1	D7
[mm]	±0.05										
10	14	2	2	3	11.6	7	2.2	2	5	2.4	M3
16	19	-	5.8	4	16	-	3.2	2.5	5	2.5	M3
25	29.5	-	8.75	5	21	9	3.2	3	7	3.3	M4
32	38	-	11	6	24	15	4.3	3	9	5.1	M6
40	49	-	11	8	28.4	15	5.3	4	12	6.4	M8

Size	D10 ∅ h7	D11 ∅	EE	H1	H2	H3	H4 ±0.2	H5	H6 ±0.05	H7
[mm]										
10	5	3.2	M3	56.3	46	30.8	38.25	3.5	10.95	5.75
16	5	3.2	M3	81	67	45.5	66	4.5	15.5	7.5
25	7	5.3	M5	100	84	57	83.7	5.5	19.2	8.8
32	9	6.4	G1/8	116	96.2	65	100.5	6.5	22.5	11
40	12	10.3	G1/8	129	108.4	71.5	99.5	7	24.5	12

1) Tolerance for centring hole ±0.02 mm; tolerance for thread ±0.1 mm

Data sheet

Size	H8	H9 ²⁾	H10	H11	H12	H14	H15	L1	L2 ¹⁾
[mm]						-0.2	-0.3	±0.05	
10	7	12.3	8.8	16	7	2.4	1.2	24	15
16	9	7.5	12.25	23	7	2.4	1.2	34	16
25	11	7.5	11.8	31	9	3	1.4	44	25
32	13	11	20	25	15	4	1.9	53	29
40	14	17.5	9	46	15	5	2.4	59	33

Size	L3	L4	L5	T1	T2	T3	W1	W2
[mm]	±0.02		-0.02/ -0.05	+0.5	+0.1	+1	+3°/-1°	±1°
10	12.4	14	5.5	3.5	1.2	through	18	3
16	17	18	8	4.5	1.2	5.8	18	3
25	22.2	26	10	4.5	1.6	6.4	18	3
32	25.8	29	12	7.5	2.1	12.9	18	3
40	30	32	15	6	2.6	13.4	18	3

1) Tolerance for centring hole ±0.02 mm; tolerance for thread ±0.1 mm

2) Tolerance for centring hole -0.05 mm; tolerance for thread ±0.1 mm

Ordering data

Size	Double-acting without compression spring		Single-acting or with gripping force retention closing	
	Part no.	Type	Part no.	Type
[mm]				
10	1310177	DHWS-10-A	-	
16	1310178	DHWS-16-A	1310179	DHWS-16-A-NC
25	1310180	DHWS-25-A	1310181	DHWS-25-A-NC
32	1310182	DHWS-32-A	1310183	DHWS-32-A-NC
40	1310184	DHWS-40-A	1310185	DHWS-40-A-NC

Accessories



Adapter kit
HAPG, HAPS, HMSV

Material:
Wrought aluminium alloy
Free of copper and PTFE
RoHS-compliant

 **Note**
The kit includes the individual mounting interface as well as the necessary mounting material.

Permissible drive/gripper combinations with adapter kit

Download CAD data → www.festo.com

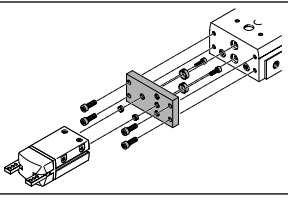
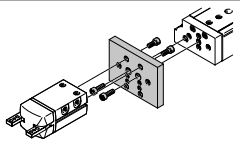
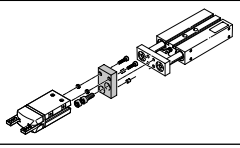
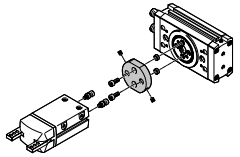
Combination	Drive Size	Gripper Size	Mounting option		Adapter kit		
					CRC ¹⁾	Part no.	Type
DGST/DHWS	DGST	DHWS			DHAA		
	10	10	■	■	2	8161907	DHAA-G-G8-10-B20-10
	12	16	■	■		8161909	DHAA-G-G8-12-B20-16
	16	16	■	■		8161908	DHAA-G-G8-16-B20-16
	20	25	■	■		8161905	DHAA-G-G8-20-B20-25
	25	32	■	■		8161906	DHAA-G-G8-25-B20-32
DGSL/DHWS	DGSL	DHWS			HMSV		
	8, 10	10	■	■	2	548784	HMSV-54
	12, 16	16	■	■		548785	HMSV-55
	20, 25	25, 32	■	■		548786	HMSV-56
DPZ/DHWS	DPZ	DHWS			HAPG		
	10, 16	16	■	–	2	163250	HAPG-1
	16	25	■	–		163251	HAPG-2
	20	25	■	–		163252	HAPG-3
	25, 32	32	■	–		163253	HAPG-4
DRRD/DHWS	DRRD	DHWS			DHAA		
	8	10	■	■	2	2816591	DHAA-G-Q11-8-B2/B3-10
	10	10	■	■		2816068	DHAA-G-Q11-10-B2/B3-10
	12	10	■	■		2814790	DHAA-G-Q11-12-B2/B3-10
	12	16	■	■		2811183	DHAA-G-Q11-12-B2/B3-16
	16	16	■	■		1979085	DHAA-G-Q11-16-B2/B3-16
	16	25	■	■		1978889	DHAA-G-Q11-16-B2/B3-25
	20	25	■	■		1978443	DHAA-G-Q11-20-B2/B3-25
	20	32	■	■		1979912	DHAA-G-Q11-20-B2/B3-32
	25	25	■	■		1801802	DHAA-G-Q11-25-B2/B3-25
	25	32	■	■		1802969	DHAA-G-Q11-25-B2/B3-32
	32	32	■	■		1979992	DHAA-G-Q11-32-B2/B3-32
	32	40	■	■		1980014	DHAA-G-Q11-32-B2/B3-40
	35, 40	40	■	■		1980059	DHAA-G-Q11-3 5/40-B2/B3-40

1) Corrosion resistance class CRC 2 to Festo standard FN 940070

Moderate corrosion stress. Indoor applications in which condensation can occur. External visible parts with primarily decorative surface requirements which are in direct contact with a normal industrial environment.

Accessories



Adapter kit DHAA, HAPG

Material:
Wrought aluminium alloy
Free of copper and PTFE
RoHS-compliant



Note

The kit includes the individual mounting interface as well as the necessary mounting material.

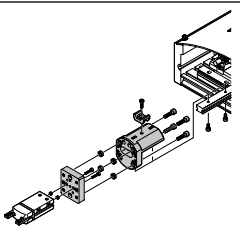
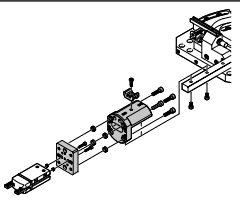
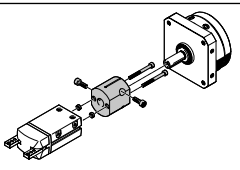
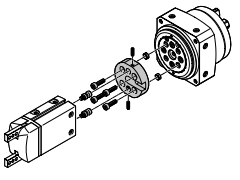
Permissible drive/gripper combinations with adapter kit						Download CAD data → www.festo.com	
Combination	Drive Size	Gripper Size	Mounting option		Adapter kit CRC ¹⁾	Part no.	Type
							
	HSP	DHWS			HAPG		
	12	10	■	–	2	192709	HAPG-60-S1
						540881	HAPG-70-B
	16	10	■	–		192706	HAPG-37-S1
						540882	HAPG-71-B
	16	16	■	–		192705	HAPG-36-S1
						540882	HAPG-71-B
25	16	■	–		192705	HAPG-36-S1	
					540883	HAPG-72-B	
25	25	■	–		193922	HAPG-37-S4	
					540883	HAPG-72-B	
	HSW	DHWS			HAPG		
	12, 16	10	■	–	2	192706	HAPG-37-S1
						540882	HAPG-71-B
	12, 16	16	■	–		192705	HAPG-36-S1
					540882	HAPG-71-B	
	DSM-...-FW	DHWS			HAPG		
	6, 8, 10	10	■	■	2	187568	HAPG-34
	DSM-...	DHWS			HAPG		
	12	16	■	■	2	163266	HAPG-17
	16	16	■	■		163267	HAPG-18
	16	25	■	■		163268	HAPG-19
	25	25	■	■		163269	HAPG-20
	25	32	■	■		163270	HAPG-21
32	32	■	■		163271	HAPG-22	
	DSM-...-HD	DHWS			DHAA		
	12	16	■	■	2	8072157	DHAA-G-R3-12-B18-10
	12	10	■	■		8072172	DHAA-G-R3-12-B20-10
	16	16	■	■		8071917	DHAA-G-R3-16-B18-10
	16	25	■	■		8079173	DHAA-G-R3-16-B18-16
	25	25	■	■		8071956	DHAA-G-R3-25-B18-16
	25	32	■	■		8079201	DHAA-G-R3-25-B20-32
	32	32	■	■		8079208	DHAA-G-R3-32-B18-25
	32	40	■	■		8079212	DHAA-G-R3-32-B20-40

1) Corrosion resistance class CRC 2 to Festo standard FN 940070

Moderate corrosion stress. Indoor applications in which condensation can occur. External visible parts with primarily decorative surface requirements which are in direct contact with a normal industrial environment.

Accessories



Adapter kit
DHAA, HAPG, HMSV

Material:
Wrought aluminium alloy
Free of copper and PTFE
RoHS-compliant

 **Note**
The kit includes the individual mounting interface as well as the necessary mounting material.

Permissible drive/gripper combinations with adapter kit

Download CAD data → www.festo.com

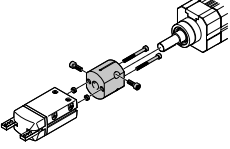
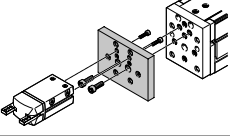
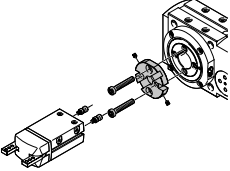
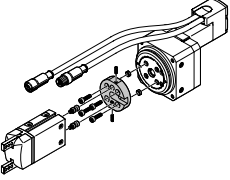
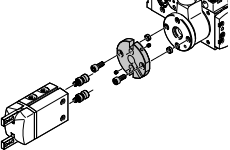
Combination	Drive Size	Gripper Size	Mounting option		Adapter kit CRC ¹⁾	Part no.	Type
							
DSL/DHWS	DSL	DHWS			HAPG		
	16	16	■	■	2	163266	HAPG-17
	20	16	■	■		163267	HAPG-18
	20	25	■	■		163268	HAPG-19
	25	25	■	■		163269	HAPG-20
	25	32	■	■		163270	HAPG-21
	32	32	■	■		163271	HAPG-22
EGSL/DHWS	EGSL	DHWS			HMSV		
	35	10	■	■	2	548784	HMSV-54
	45, 55	16	■	■		1088262	HMSV-70
	75	25, 32	■	■		548785	HMSV-55
						548786	HMSV-56
ERMB/DHWS	ERMB	DHWS			HAPG		
	20	25	■	■	2	184479	HAPG-SD2-3
	25	25	■	■		184482	HAPG-SD2-6
	20	32	■	■		184480	HAPG-SD2-4
	25	32	■	■		184483	HAPG-SD2-7
	32	32	■	■		184485	HAPG-SD2-9
	32	40	■	■		184486	HAPG-SD2-10
ERMO/DHWS	ERMO	DHWS			DHAA		
	12	16	■	■	2	8072157	DHAA-G-R3-12-B18-10
	12	10	■	■		8072172	DHAA-G-R3-12-B20-10
	16	16	■	■		8071917	DHAA-G-R3-16-B18-10
	16	25	■	■		8079173	DHAA-G-R3-16-B18-16
	25	25	■	■		8071956	DHAA-G-R3-25-B18-16
	25	32	■	■		8079201	DHAA-G-R3-25-B20-32
	32	32	■	■		8079208	DHAA-G-R3-32-B18-25
	32	40	■	■		8079212	DHAA-G-R3-32-B20-40
EHMB/DHWS	EHMB	DHWS			HAPG		
	20	32	■	■	2	184485	HAPG-SD2-9
	20	40	■	■		184486	HAPG-SD2-10
	25, 32	40	■	■		526027	HAPG-SD2-21

1) Corrosion resistance class CRC 2 to Festo standard FN 940070

Moderate corrosion stress. Indoor applications in which condensation can occur. External visible parts with primarily decorative surface requirements which are in direct contact with a normal industrial environment.

Accessories

Ordering data						
	For size [mm]	Description	Weight [g]	Part no.	Type	PU ¹⁾
Centring sleeve ZBH						Data sheets → Internet: zbh
	10, 16	For centring the gripper during mounting	1	189652	ZBH-5	10
	25		1	186717	ZBH-7	
	32		1	8137184	ZBH-9-B	
	40		1	8137185	ZBH-12-B	



1) Packaging unit

Ordering data				
Type	For size	Weight [g]	Part no.	Type
Position sensor SMH-S1				
	10	20	175711	SMH-S1-HGW10
	Data sheets → Internet: smh-s1			

Signal converter SVE4 for position sensor SMH-S1

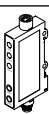
- Converts analogue signals into switching points
- Switching function freely programmable with teach-in
- Threshold value, hysteresis or window comparator

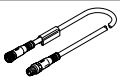
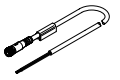
Ordering data							
Type	For size	Input connection	Output connection	Switching output	Weight [g]	Part no.	Type
Signal converter SVE4							
	10	Socket M8x1, 4-pin	Plug M8x1, 4-pin	2x PNP	19	544216	SVE4-HS-R-HM8-2P-M8
				2x NPN		544219	SVE4-HS-R-HM8-2N-M8
Data sheets → Internet: sve4							

Ordering data – Connecting cables					
	Electrical connection, left	Electrical connection, right	Cable length [m]	Part no.	Type
Connection between position sensor and signal converter					
	Straight socket, M8x1, 4-pin	Straight plug, M8x1, 4-pin	2.5	554035	NEBU-M8G4-K-2.5-M8G4
			Data sheets → Internet: nebu		
Connection between signal converter and controller					
	Straight socket, M8x1, 4-pin	Cable, open end, 4-wire	2.5	541342	NEBU-M8G4-K-2.5-LE4
			5	541343	NEBU-M8G4-K-5-LE4
	Angled socket, M8x1, 4-pin	Cable, open end, 4-wire	2.5	541344	NEBU-M8W4-K-2.5-LE4
			5	541345	NEBU-M8W4-K-5-LE4

Accessories

Proximity sensor for size 16 ... 40



Ordering data – Proximity sensor for T-slot, magneto-resistive

Data sheets → Internet: smt

	Type of mounting	Electrical connection, outlet direction of connection	Switching output	Cable length [m]	Part no.	Type
N/O contact						
	Insertable in the slot lengthwise	Cable, 3-wire, lateral	PNP	2.5	547859	SMT-8G-PS-24V-E-2.5Q-OE
		Plug M8x1, 3-pin, lateral		0.3	547860	SMT-8G-PS-24V-E-0.3Q-M8D
		Cable, 3-wire, lateral	NPN	2.5	8065028	SMT-8G-NS-24V-E-2.5Q-OE
		Plug M8x1, 3-pin, lateral		0.3	8065027	SMT-8G-NS-24V-E-0.3Q-M8D

Ordering data – Connecting cables

Data sheets → Internet: nebu

	Electrical connection, left	Electrical connection, right	Cable length [m]	Part no.	Type
	Straight socket, M8x1, 3-pin	Cable, open end, 3-wire	2.5	541333	NEBU-M8G3-K-2.5-LE3
			5	541334	NEBU-M8G3-K-5-LE3
	Angled socket, M8x1, 3-pin	Cable, open end, 3-wire	2.5	541338	NEBU-M8W3-K-2.5-LE3
			5	541341	NEBU-M8W3-K-5-LE3

Position transmitter

The position transmitter continuously senses the position of the piston.
It has an analogue output with an output signal relative to the piston position.

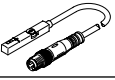
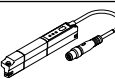

Ordering data – Position transmitter for T-slot

Data sheets → Internet: position transmitter

	For size	Position measuring range	Analogue output [V]	[mA]	Type of mounting	Electrical connection	Cable length [m]	Part no.	Type
	16 ... 40	0 ... 40	0 ... 10	–	Insertable in the slot from above	Plug M8x1, 4-pin, in-line	0.3	553744	SMAT-8M-U-E-0.3-M8D
	32, 40	0 ... 50	–	4 ... 20	Insertable in the slot from above	Plug M8x1, 4-pin, in-line	0.3	1531265	SDAT-MHS-M50-1L-SA-E-0.3-M8

Ordering data – Connecting cables

Data sheets → Internet: nebu

	Electrical connection, left	Electrical connection, right	Cable length [m]	Part no.	Type
	Straight socket, M8x1, 4-pin	Cable, open end, 4-wire	2.5	541342	NEBU-M8G4-K-2.5-LE4
			5	541343	NEBU-M8G4-K-5-LE4
	Angled socket, M8x1, 4-pin	Cable, open end, 4-wire	2.5	541344	NEBU-M8W4-K-2.5-LE4
			5	541345	NEBU-M8W4-K-5-LE4