

Pb-free
HEAT



3863X Series

Single Color ϕ 3 Flush Mount Round Shape Type

Features

Package	Φ 3 Round shape type, YPY,FY : Pale Yellow Clear epoxy FA : Pale Orange Clear epoxy FR : Pale Red Clear epoxy
Product features	<ul style="list-style-type: none">• Outer Dimension ϕ3 Flush Mount Round shape type• Operation temperature range. Storage Temperature : -40°C~100°C Operating Temperature : -40°C~85°C• Lead-free soldering compatible• RoHS compliant
Dominant wavelength	Yellow Green : 572nm (YPY) Yellow : 590nm (FY) Orange : 605nm (FA) Red : 626nm (FR)
Half Intensity Angle	YPY,FY,FA,FR : 20 deg.
Die materials	YPY,FY,FA,FR : AlGaInP
Rank grouping parameter	Sorted by luminous intensity per rank taping
Soldering methods	TTW (Through The Wave) soldering and manual soldering
ESD	AlGaInP : More than 2kV(HBM)
Packing	Bulk : 200pcs(MIN.)

Recommended Applications

Amusement Equipment, Electric Household Appliances, OA/FA, Other General Applications

Color and Luminous Intensity

(Ta=25°C)

Part No.	Material	Emitted Color	Lens Color		Dominant Wavelength		Luminous Intensity		
					λ_d (nm)		I _v (mcd)		
					TYP.	I _F	MIN.	TYP.	I _F
YPY3863X	AlGaInP	Yellow Green	Pale Yellow	Clear	572	20	180	360	20
FY3863X	AlGaInP	Yellow			590	20	360	720	20
FA3863X	AlGaInP	Orange	Pale Orange		605	20	400	800	20
FR3863X	AlGaInP	Red	Pale Red		626	20	320	640	20

Absolute Maximum Ratings

(Ta=25°C)

Item	Symbol	Absolute Maximum Ratings				Unit
		YPY	FY	FA	FR	
Power Dissipation	P_d	130	125	125	125	mW
Forward Current	I_F	50	50	50	50	mA
Pulse Forward Current ※1	I_{FRM}	200	200	200	200	mA
Derating (Ta=25°C or higher)	ΔI_F	0.67	0.67	0.67	0.67	mA/°C
Reverse Voltage	V_R	5	5	5	5	V
Operating Temperature	T_{opr}	-40~+85				°C
Storage Temperature	T_{stg}	-40~+100				°C

 ※1 I_{FRM} Measurement condition : Pulse Width ≤ 1 ms., Duty $\leq 1/20$.

Electro-Optical Characteristics

(Ta=25°C)

Item	Conditions	Symbol	Characteristics				Unit	
			YPY	FY	FA	FR		
Forward Voltage	$I_F=20\text{mA}$	V_F	TYP.	2.1	1.9	1.9	1.9	V
			MAX.	2.5	2.4	2.4	2.4	
Reverse Current	$V_R=5\text{V}$	I_R	MAX.	100	100	100	100	μA
Peak Wavelength	$I_F=20\text{mA}$	λ_p	TYP.	575	592	609	635	nm
Dominant Wavelength	$I_F=20\text{mA}$	λ_d	TYP.	572	590	605	626	nm
Spectral Line Half Width	$I_F=20\text{mA}$	$\Delta\lambda$	TYP.	15	15	15	15	nm
Half Intensity Angle	$I_F=20\text{mA}$	$2\theta_{1/2}$	TYP.	20	20	20	20	deg.

Luminous Intensity Rank

(Ta=25°C)

Rank	I _v (mcd)								Condition
	YPY		FY		FA		FR		
	MIN.	MAX.	MIN.	MAX.	MIN.	MAX.	MIN.	MAX.	
A	180	360	360	720	400	800	320	640	I _F = 20mA
B	250	500	500	1,000	560	1,120	450	900	
C	360	780	720	1,440	800	1,600	640	1,280	
D	500	1,000	1,000	2,000	1,120	2,240	900	1,800	
E	780	-	1,440	-	1,600	-	1,280	-	

Please contact our sales staff concerning rank designation.

Technical Data(YPY)

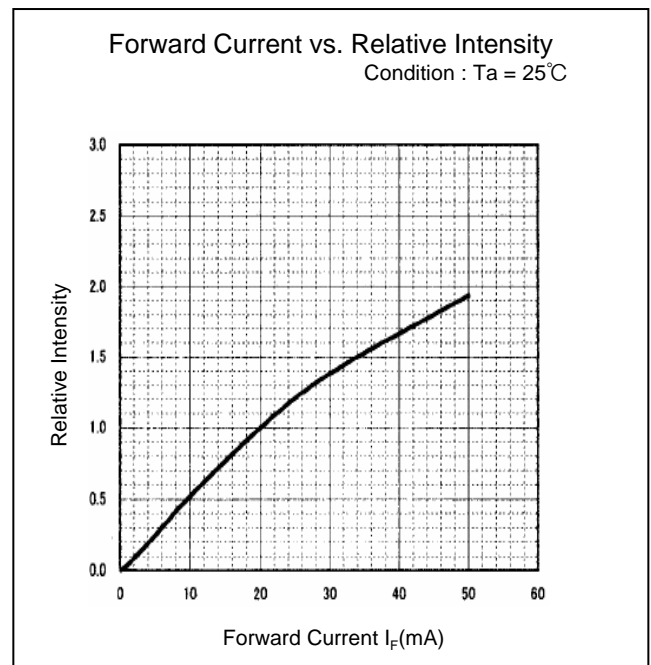
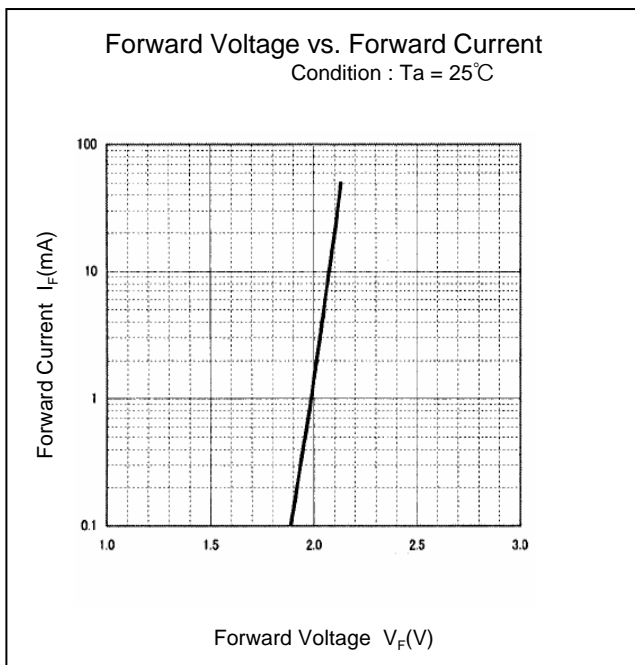
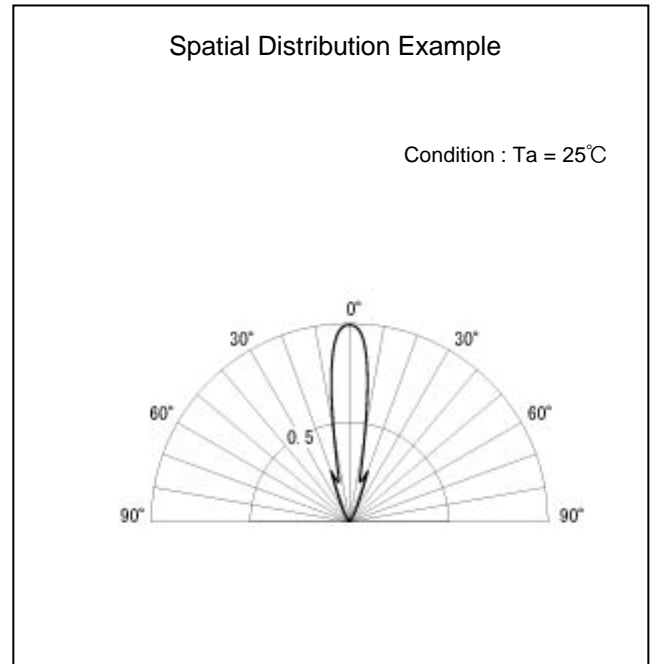
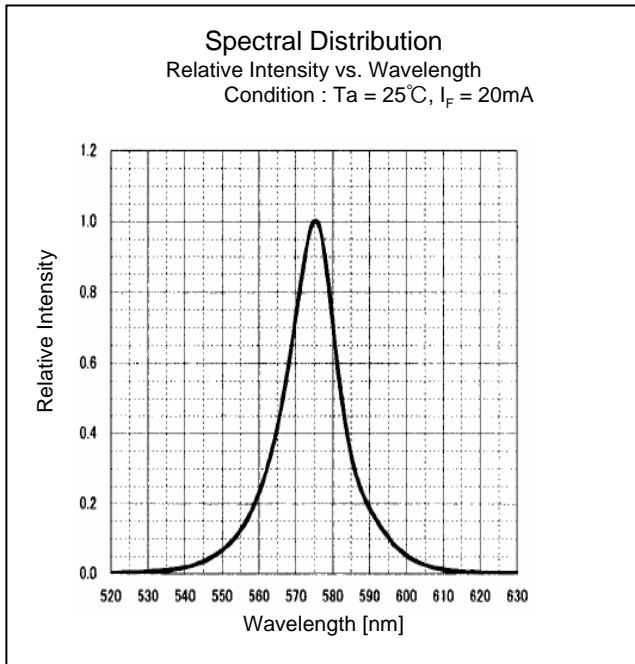

Technical Data(YPY)

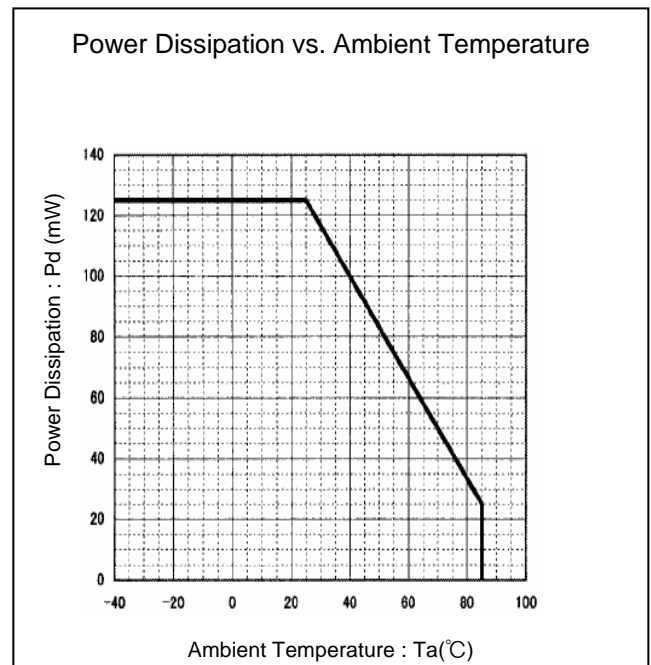
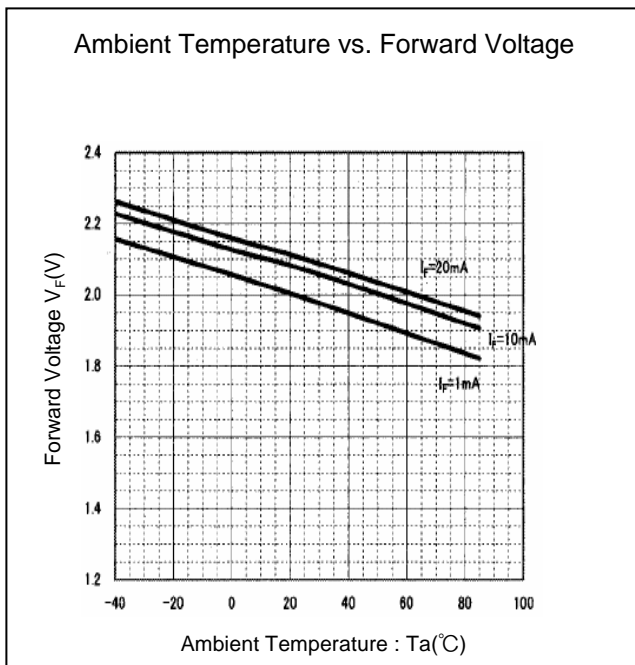
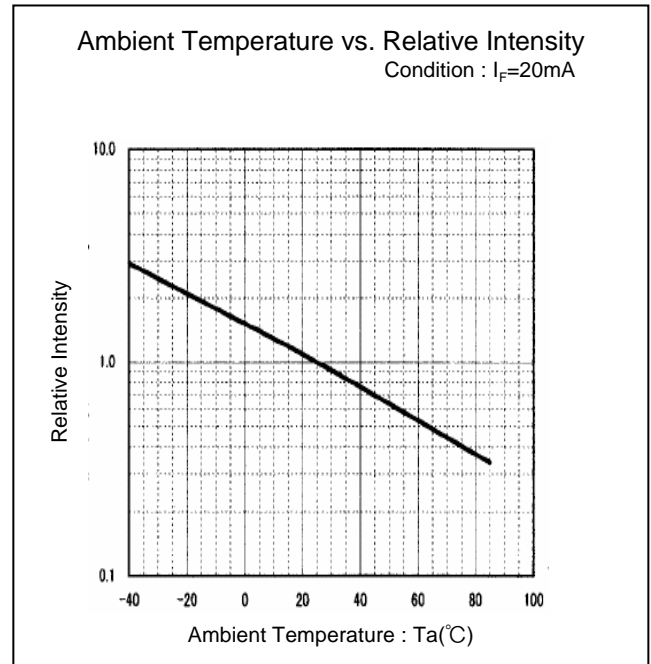
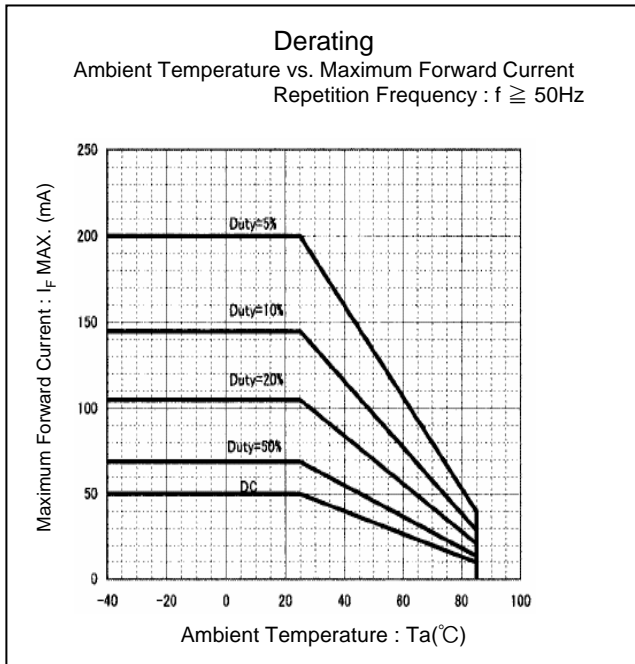

Technical Data(YPY)

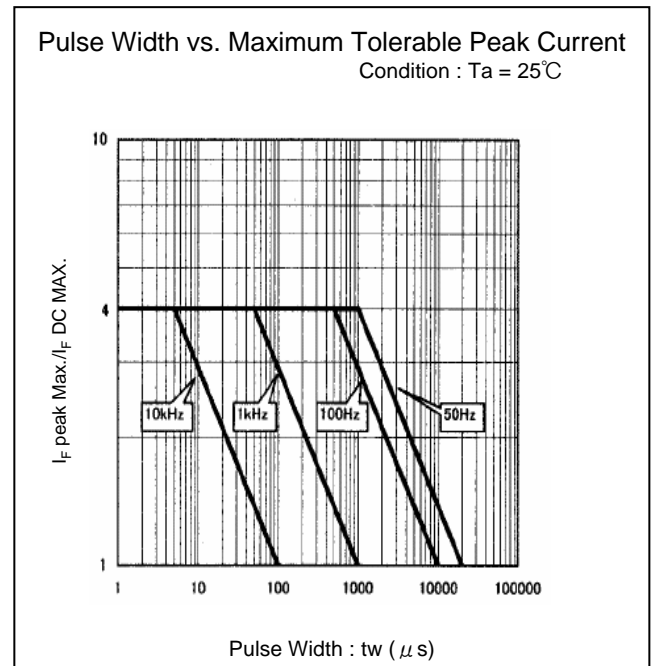
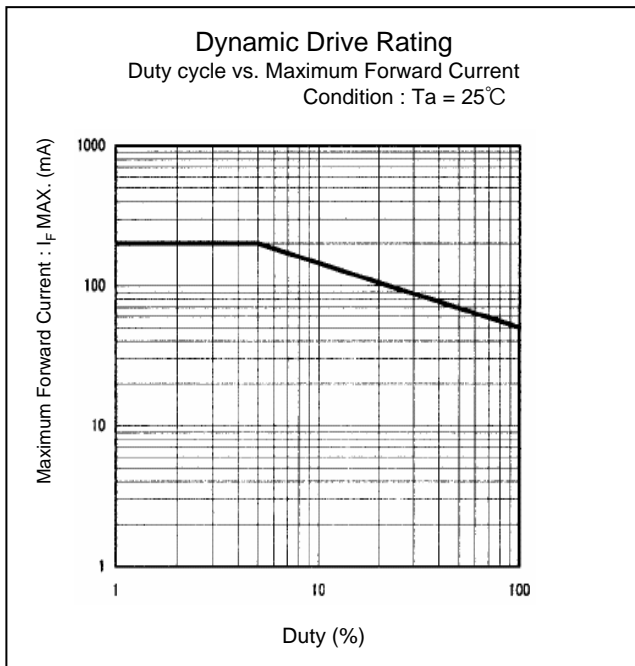

Technical Data(FY)

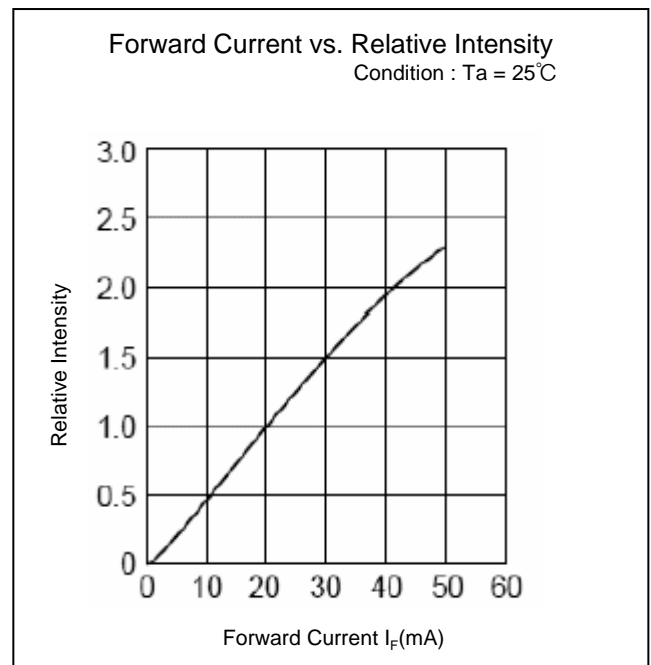
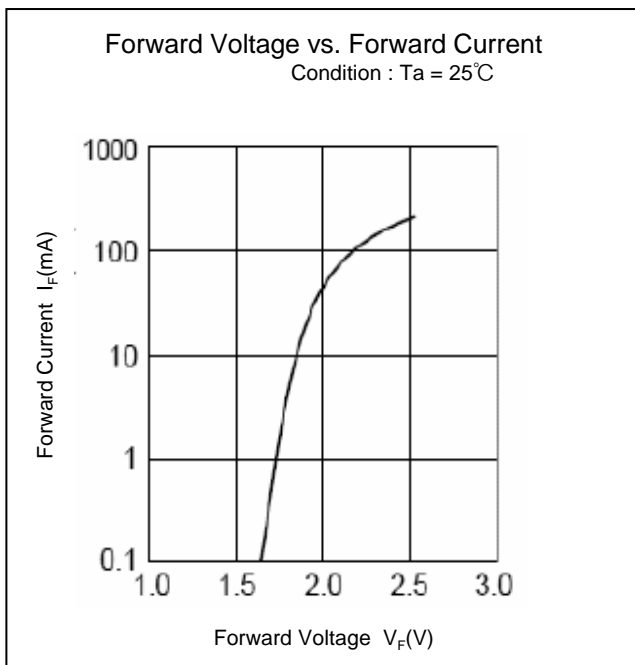
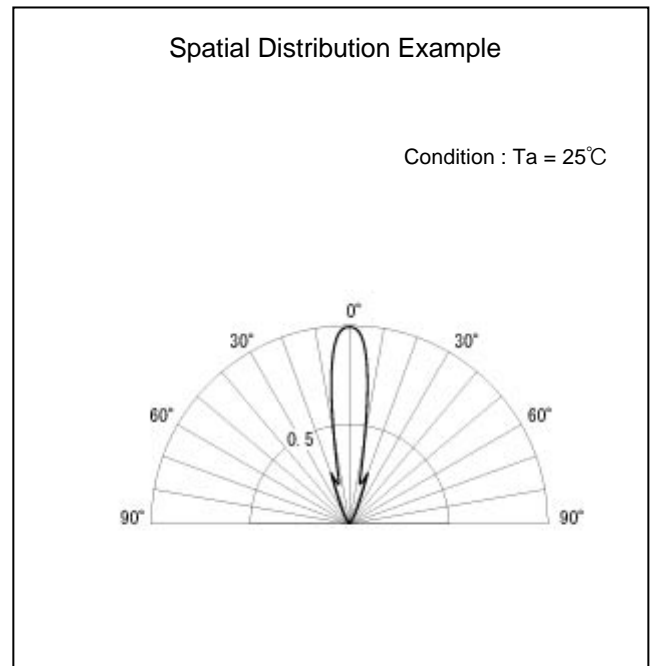
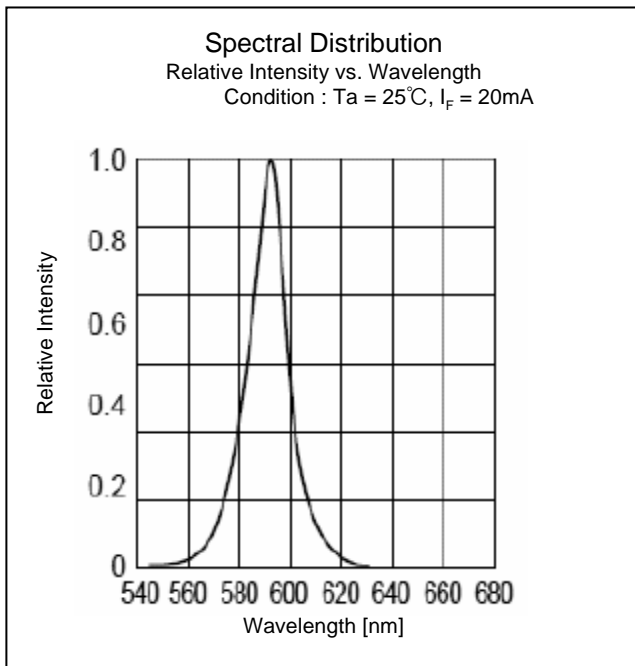

Technical Data(FY)

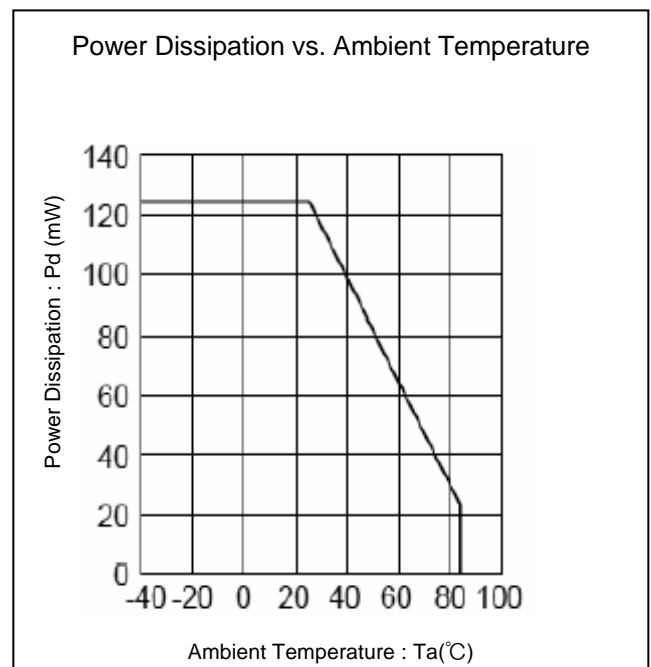
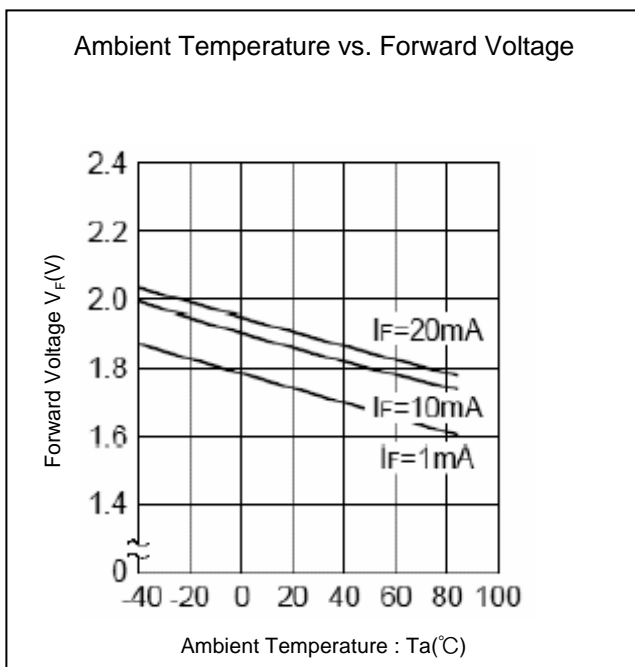
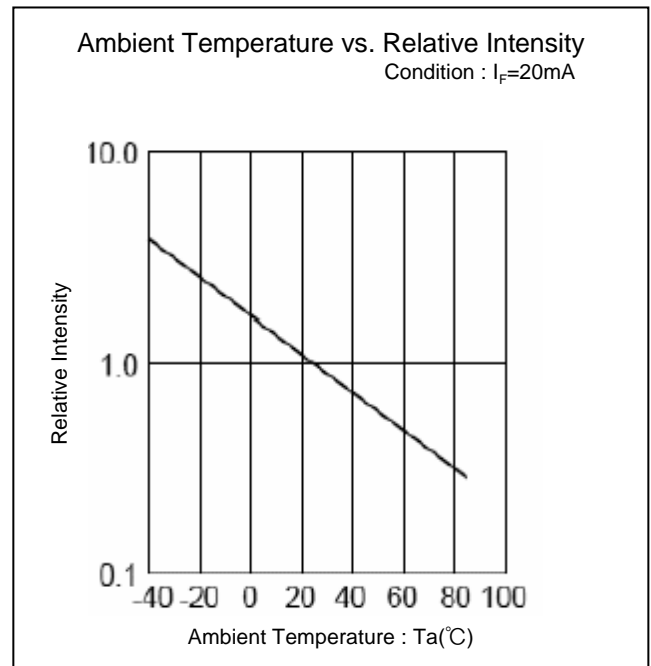
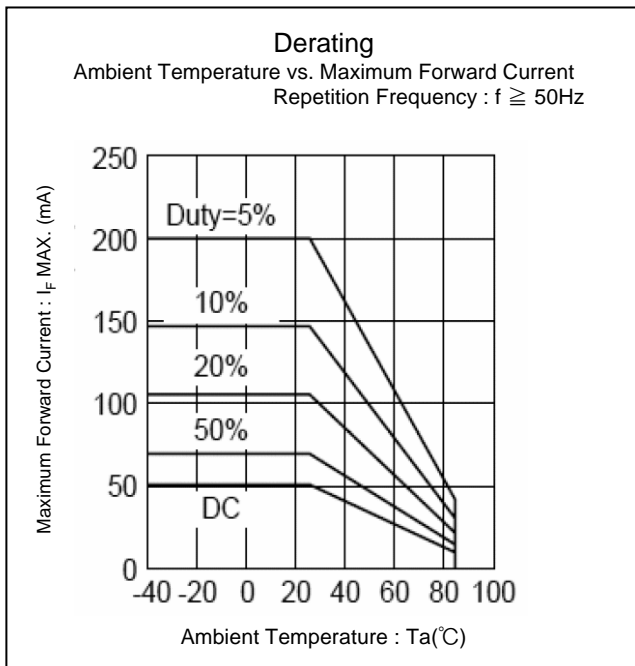

Technical Data(FY)

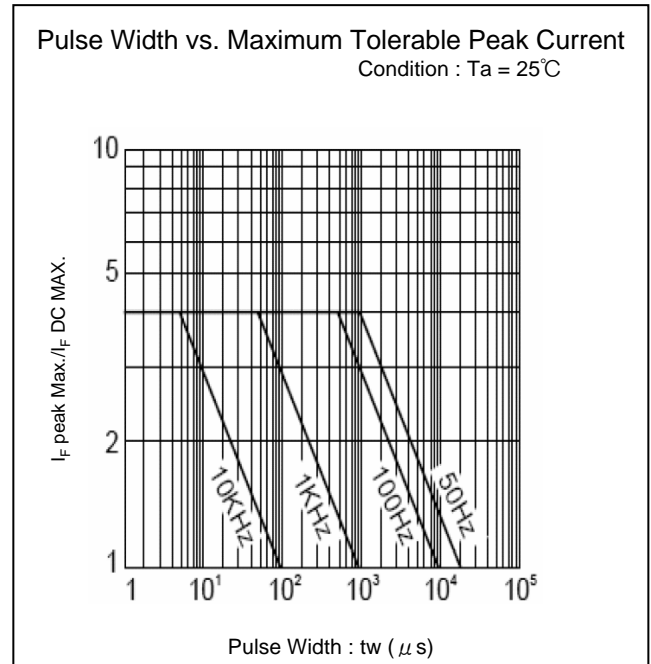
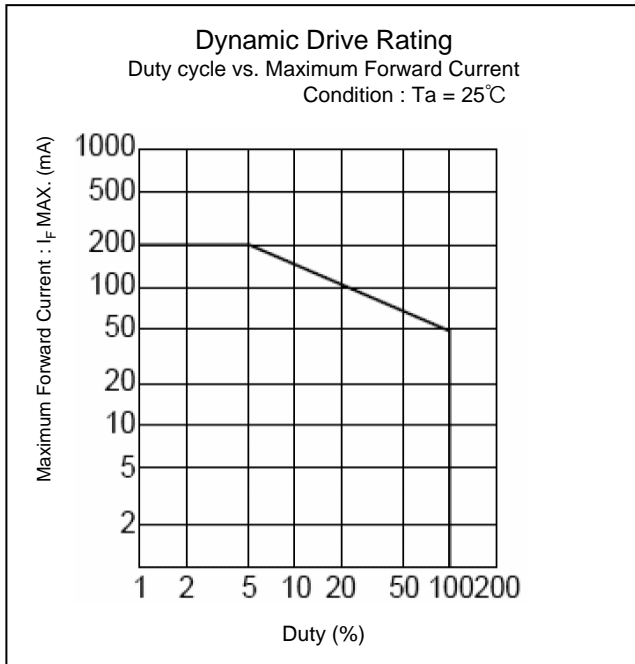

Technical Data(FA)

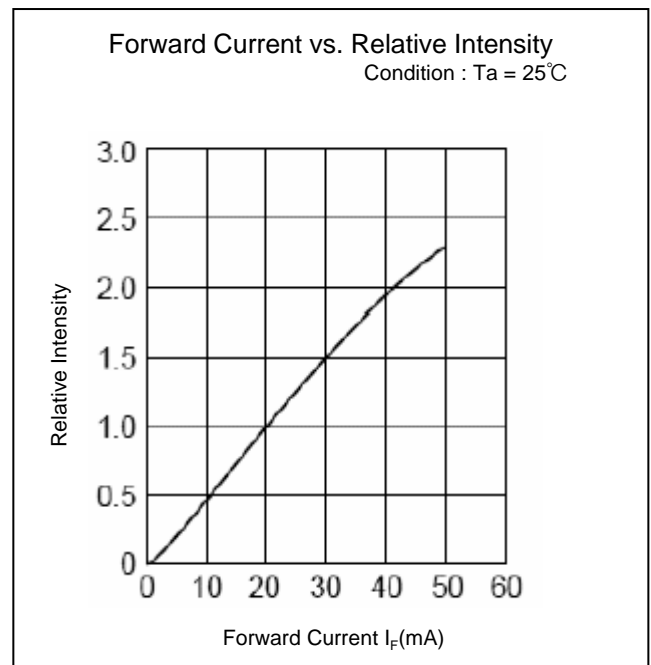
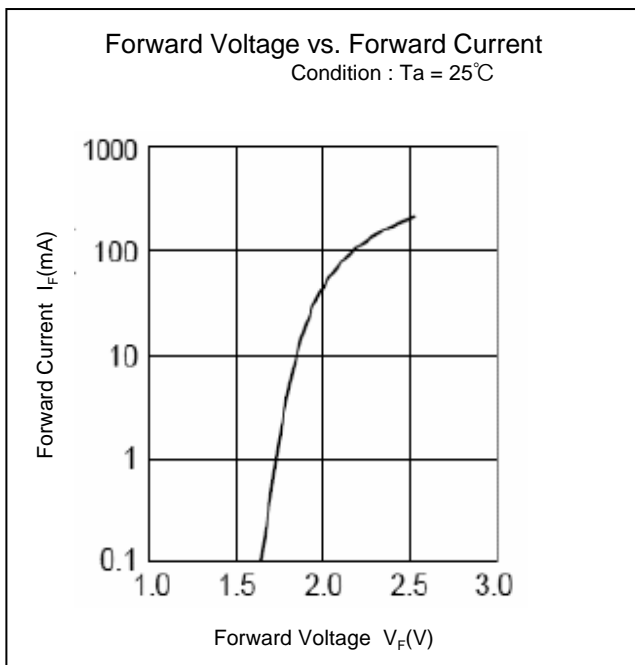
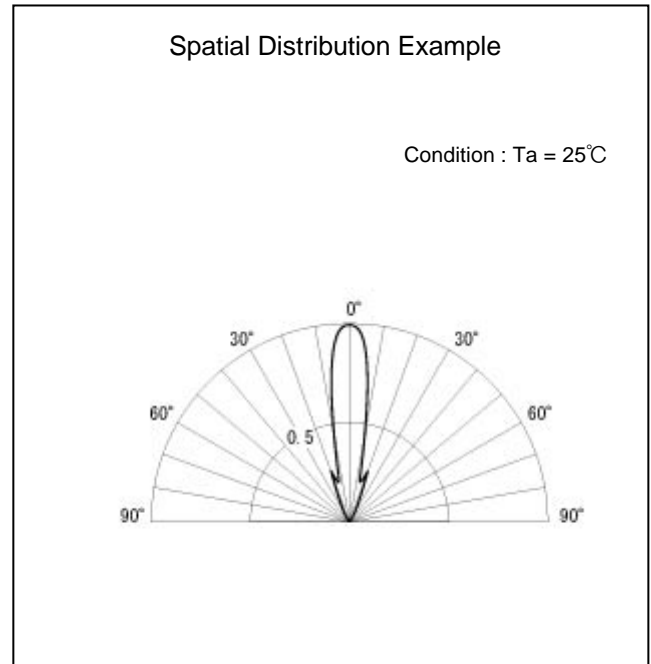
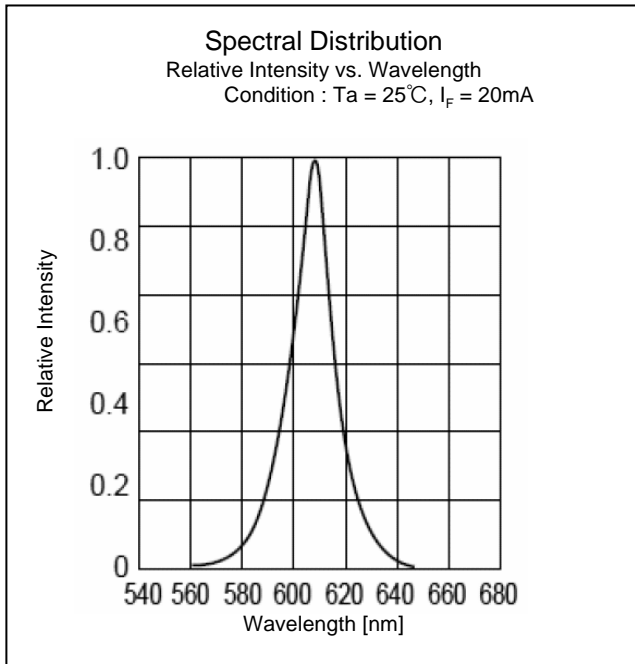

Technical Data(FA)

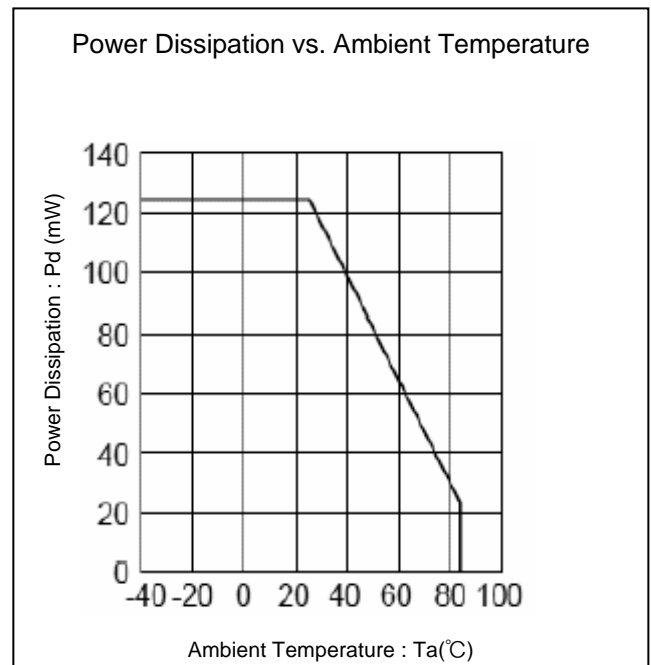
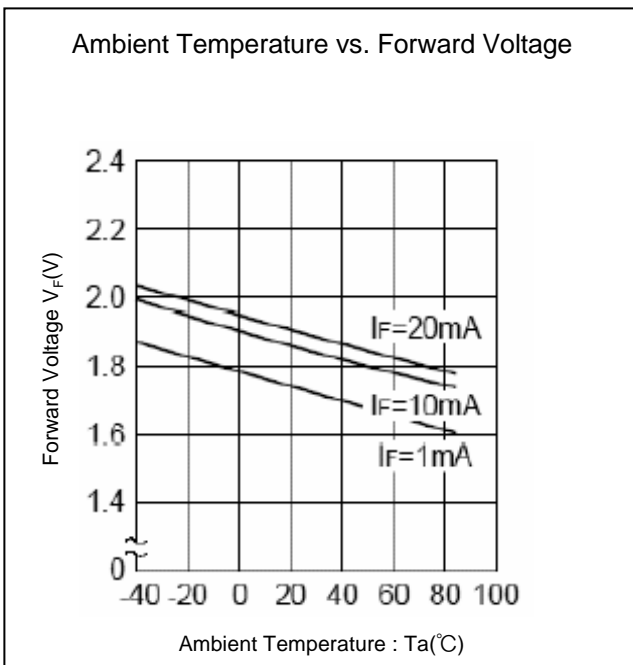
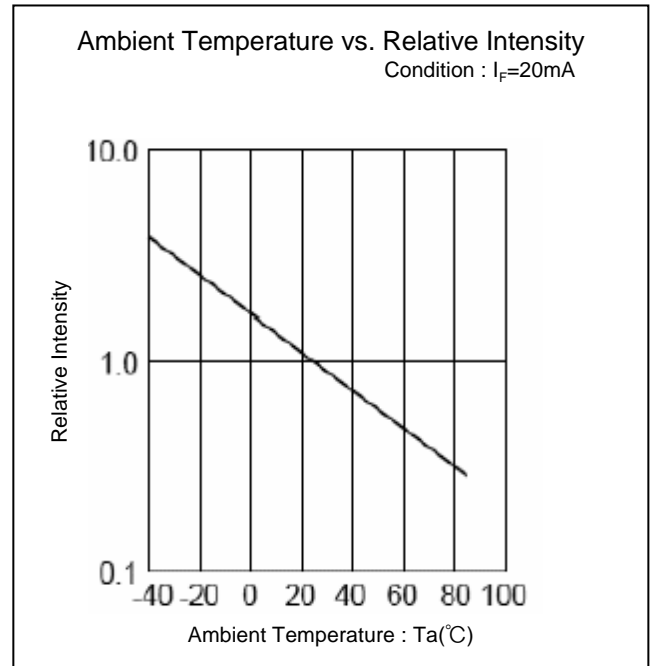
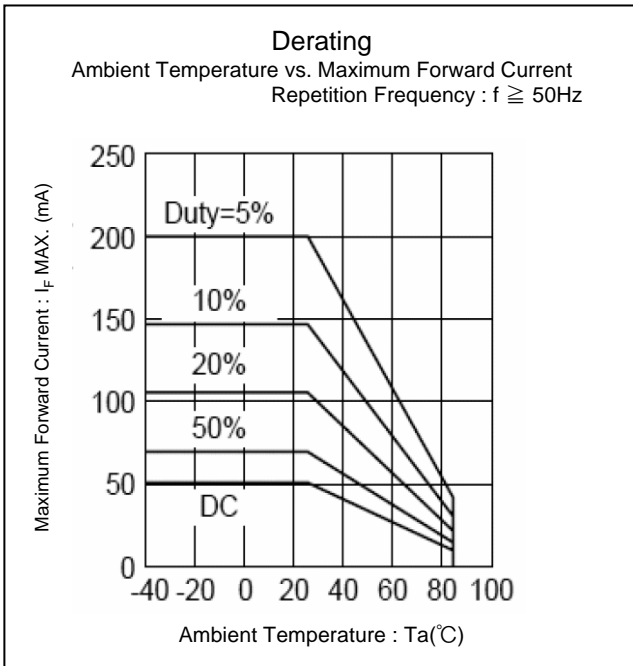

Technical Data(FA)

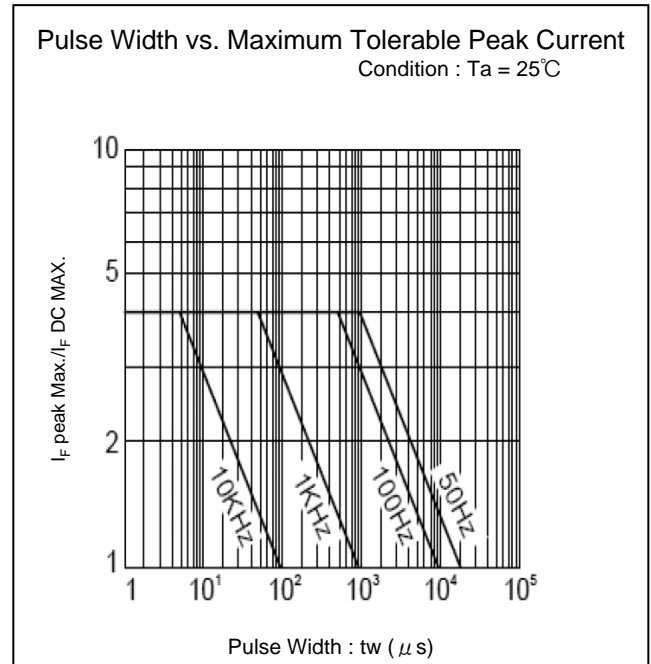
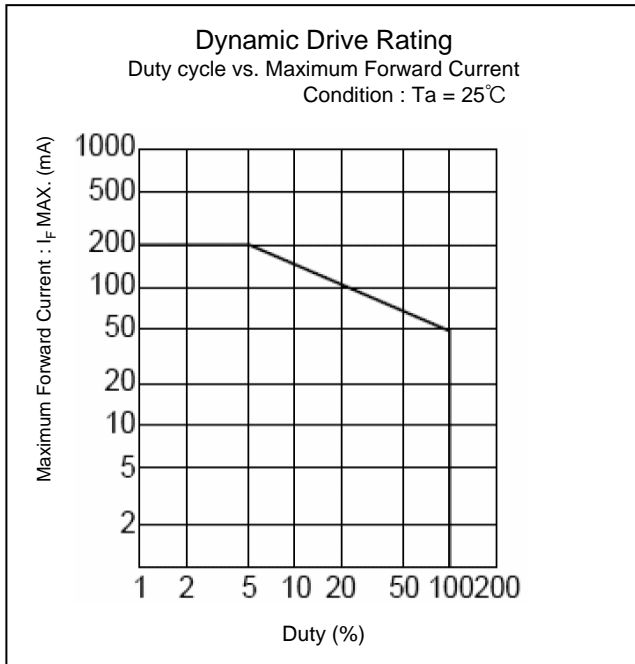

Technical Data(FR)

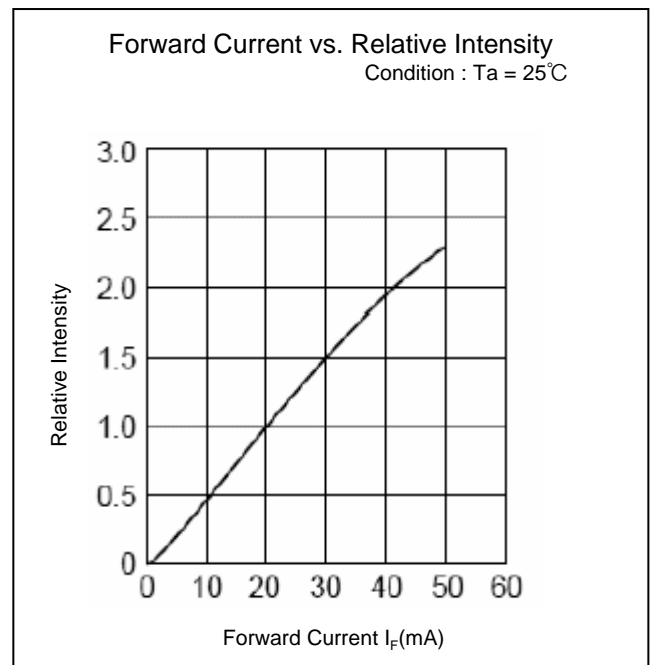
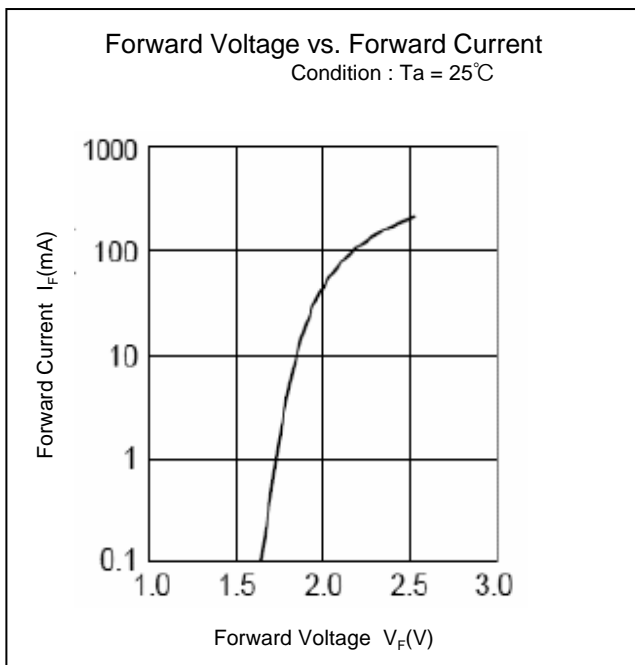
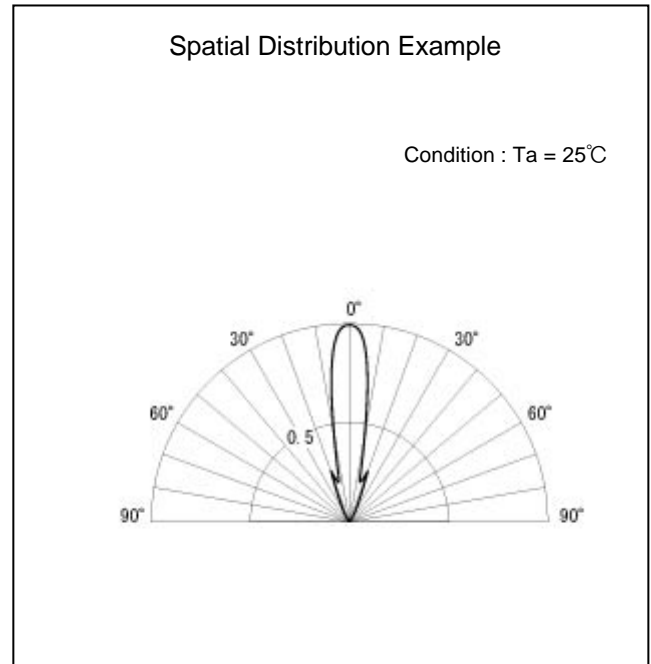
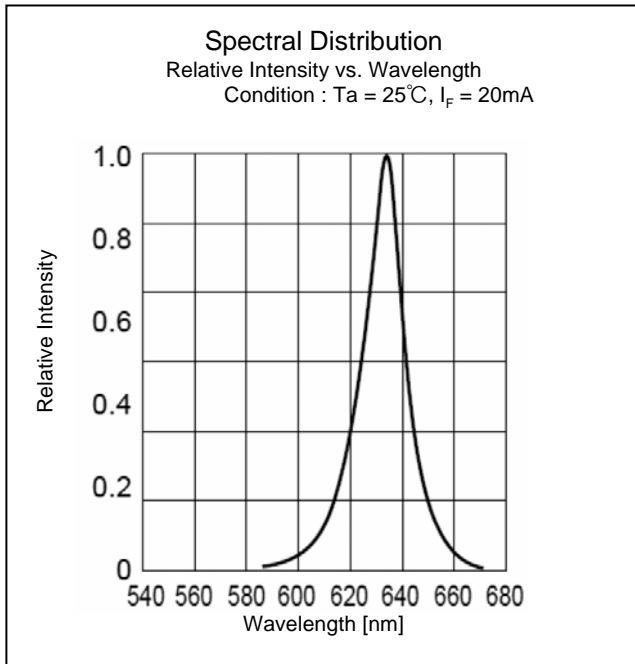

Technical Data(FR)

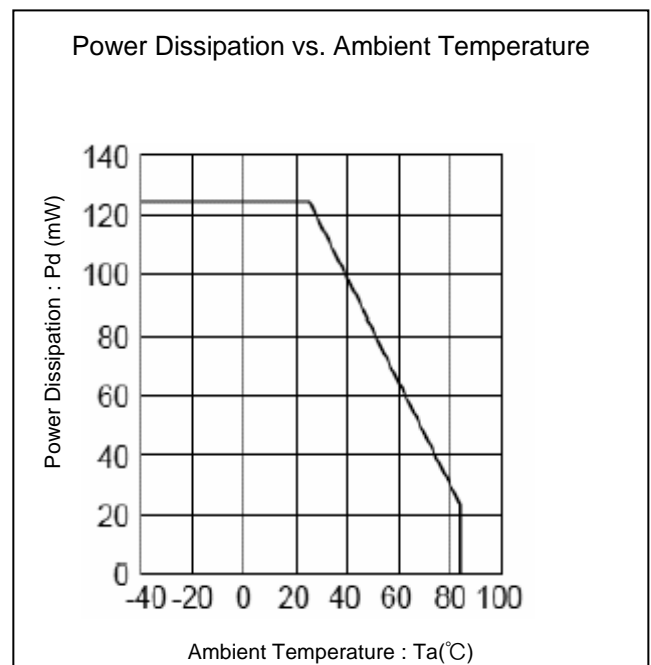
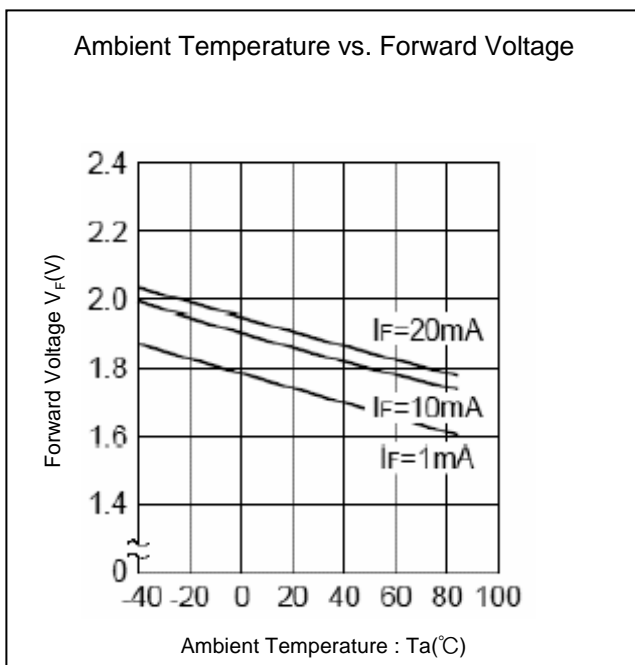
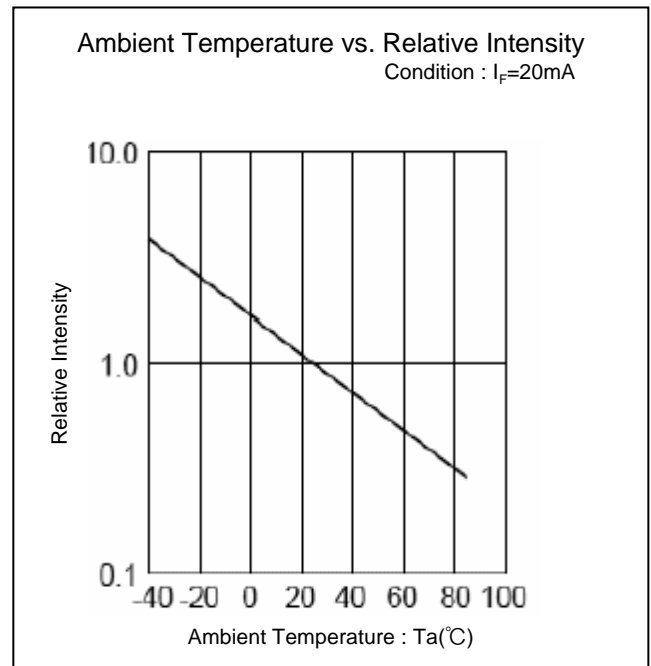
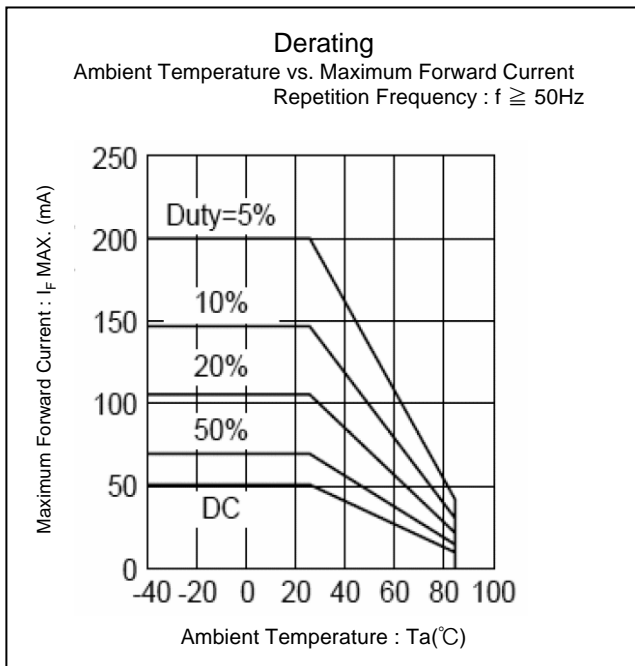

Technical Data(FR)

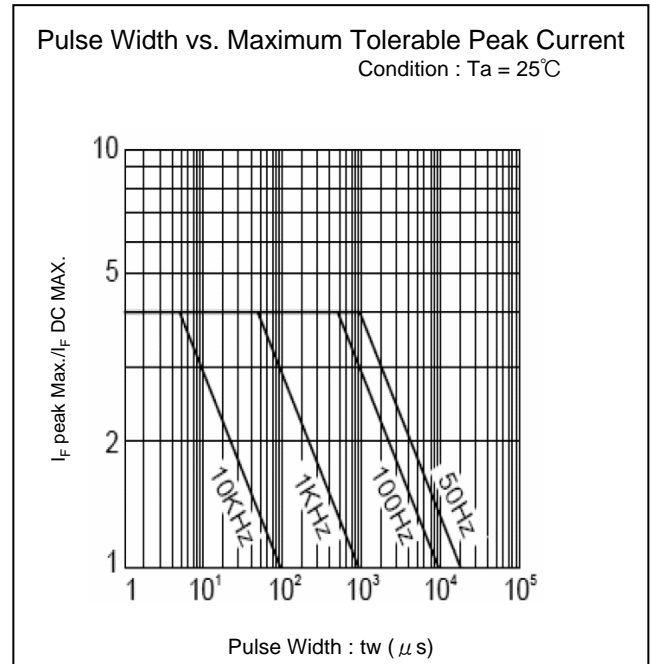
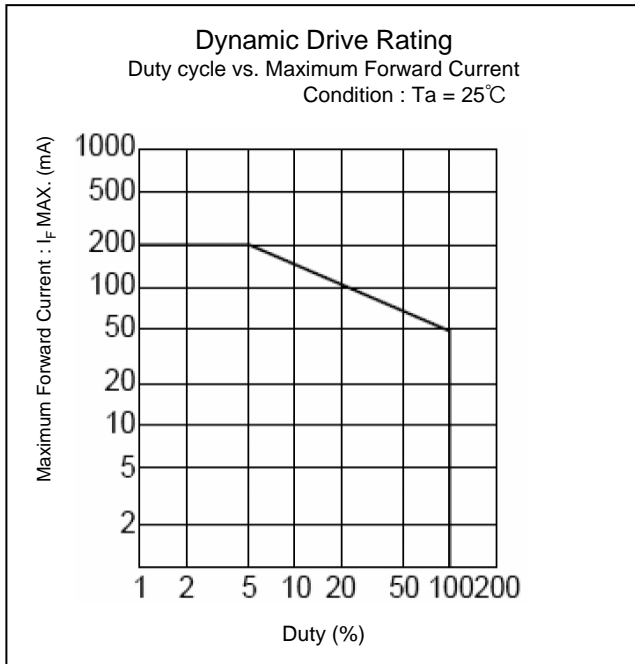

Package Dimensions

(Unit: mm)

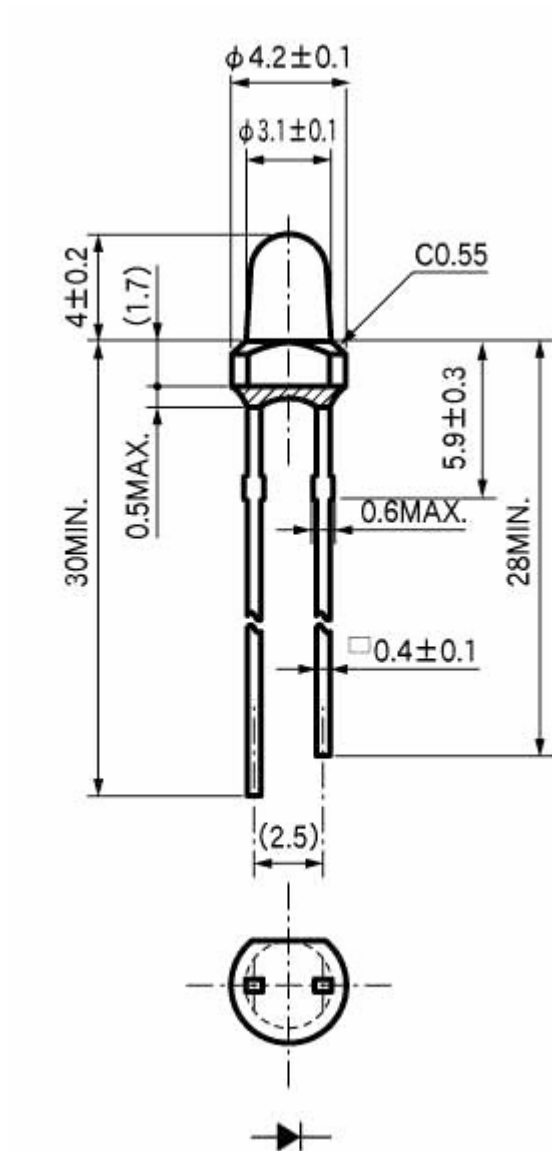

TTW (Through The Wave) soldering Conditions

Pre-heating	100 °C	(MAX.)
Solder Bath Temp.	265°C	(MAX.)
Dipping Time	5 s	(MAX.)

- 1) The dip soldering process shall be 2 times maximum.
- 2) The product shall be cooled to room temp. before the second dipping process.

※The detail is described to LED and Photodetector handling precautions of home page:
 "Mounting through-hole Type Devices" and "Soldering", and use it after the confirmation,
 please.

Manual Soldering Conditions

Iron tip temp.	400°C	(MAX.)
Soldering time and frequency	3 s	(MAX.)
	2 times	(MAX.)

※The detail is described to LED and Photodetector handling precautions of home page:
 "Mounting through-hole Type Devices" and "Soldering", and use it after the confirmation, please.

Reliability Testing Result

Reliability Testing Result	Applicable Standard	Testing Conditions	Duration	Failure
Room Temp. Operating Life	BAJED-4701/100(101)	Ta = 25°C, If = Maximum Rated Current	1,000 h	0/25
Resistance to Soldering Heat	BAJED-4701/300(302)	260±5°C, 1.6mm from package base	10s	0/25
Temperature Cycling	BAJED-4701/100(105)	Minimum Rated Storage Temperature(30min) ~Normal Temperature(15min) ~Maximum Rated Storage Temperature(30min) ~Normal Temperature(15min)	5 cycles	0/25
Wet High Temp. Storage Life	BAJED-4701/100(103)	Ta = 60±2°C, RH = 90±5%	1,000 h	0/25
High Temp. Storage Life	BAJED-4701/200(201)	Ta = Maximum Rated Storage Temperature	1,000 h	0/25
Low Temp. Storage Life	BAJED-4701/200(202)	Ta = Minimum Rated Storage Temperature	1,000 h	0/25
Lead Tension	BAJED-4701/400(401)	10N, 1time (□0.4 and Flat Package : 5N)	10s	0/10
Vibration, Variable Frequency	BAJED-4701/400(403)	98.1m/s ² (10G), 100 ~ 2KHz sweep for 20min., XYZ each direction	2 h	0/10

Failure Criteria

Items	Symbols	Conditions	Failure criteria
Luminous Intensity	Iv	If Value of each product Luminous Intensity	Testing Min. Value < Spec. Min. Value x 0.5
Forward Voltage	V _F	If Value of each product Forward Voltage	Testing Max. Value ≥ Spec. Max. Value x 1.2
Reverse Current	I _R	V _R = Maximum Rated Reverse Voltage V	Testing Max. Value ≥ Spec. Max. Value x 2.5
Cosmetic Appearance	-	-	Occurrence of notable decoloration, deformation and cracking

Special Notice to Customers Using the Products and Technical Information Shown in This Data Sheet

- 1) The technical information shown in the data sheets are limited to the typical characteristics and circuit examples of the referenced products. It does not constitute the warranting of industrial property nor the granting of any license.
- 2) For the purpose of product improvement, the specifications, characteristics and technical data described in the data sheets are subject to change without prior notice. Therefore it is recommended that the most updated specifications be used in your design.
- 3) When using the products described in the data sheets, please adhere to the maximum ratings for operating voltage, heat dissipation characteristics, and other precautions for use. We are not responsible for any damage which may occur if these specifications are exceeded.
- 4) The products that have been described to this catalog are manufactured so that they will be used for the electrical instrument of the benchmark (OA equipment, telecommunications equipment, AV machine, home appliance and measuring instrument).
The application of aircrafts, space borne application, transportation equipment, medical equipment and nuclear power control equipment, etc. needs a high reliability and safety, and the breakdown and the operation might influence the life or the human body. Please consult us beforehand if you plan to use our product for the usages of aircrafts, space borne application, transportation equipment, medical equipment and nuclear power control equipment, etc. except OA equipment, telecommunications equipment, AV machine, home appliance and measuring instrument.
- 5) In order to export the products or technologies described in this data sheet which are under the "Foreign Exchange and Foreign Trade Control Law," it is necessary to first obtain an export permit from the Japanese government.
- 6) No part of this data sheet may be reprinted or reproduced without prior written permission from Stanley Electric Co., Ltd.
- 7) The most updated edition of this data sheet can be obtained from the address below:
<http://www.stanley-components.com>