

FGA25S125P

1250 V, 25 A Shorted-anode IGBT

Features

- High Speed Switching
- Low Saturation Voltage: $V_{CE(sat)} = 1.8\text{ V @ } I_C = 25\text{ A}$
- High Input Impedance
- RoHS Compliant

Applications

- Induction Heating, Microwave Oven

General Description

Using advanced field stop trench and shorted-anode technology, Fairchild's shorted-anode trench IGBTs offer superior conduction and switching performances for soft switching applications. The device can operate in parallel configuration with exceptional avalanche capability. This device is designed for induction heating and microwave oven.

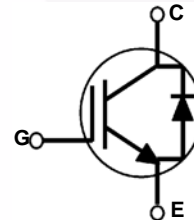
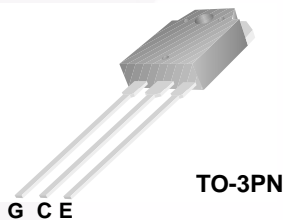

Absolute Maximum Ratings

| Symbol | Description | Rating | Unit |
|-------------|---|-------------|------------------|
| V_{CES} | Collector to Emitter Voltage | 1250 | V |
| V_{GES} | Gate to Emitter Voltage | ± 25 | V |
| I_C | Collector Current @ $T_C = 25^\circ\text{C}$ | 50 | A |
| | Collector Current @ $T_C = 100^\circ\text{C}$ | 25 | A |
| $I_{CM(1)}$ | Pulsed Collector Current | 75 | A |
| I_F | Diode Continuous Forward Current @ $T_C = 25^\circ\text{C}$ | 50 | A |
| | Diode Continuous Forward Current @ $T_C = 100^\circ\text{C}$ | 25 | A |
| P_D | Maximum Power Dissipation @ $T_C = 25^\circ\text{C}$ | 250 | W |
| | Maximum Power Dissipation @ $T_C = 100^\circ\text{C}$ | 125 | W |
| T_J | Operating Junction Temperature | -55 to +175 | $^\circ\text{C}$ |
| T_{stg} | Storage Temperature Range | -55 to +175 | $^\circ\text{C}$ |
| T_L | Maximum Lead Temp. for soldering Purposes, 1/8" from case for 5 seconds | 300 | $^\circ\text{C}$ |

Thermal Characteristics

| Symbol | Parameter | Typ. | Max. | Unit |
|------------------------------|--|------|------|--------------------|
| $R_{\theta JC}(\text{IGBT})$ | Thermal Resistance, Junction to Case, Max | - | 0.6 | $^\circ\text{C/W}$ |
| $R_{\theta JA}$ | Thermal Resistance, Junction to Ambient, Max | - | 40 | $^\circ\text{C/W}$ |

Notes:

1: Limited by T_{jmax}

Package Marking and Ordering Information

| Device Marking | Device | Package | Reel Size | Tape Width | Quantity |
|----------------|------------|---------|-----------|------------|----------|
| FGA25S125P | FGA25S125P | TO-3PN | - | - | 30 |

Electrical Characteristics of the IGBT T_C = 25°C unless otherwise noted

| Symbol | Parameter | Test Conditions | Min. | Typ. | Max. | Unit |
|----------------------------------|---|--|------|------|------|------|
| Off Characteristics | | | | | | |
| I _{CES} | Collector Cut-Off Current | V _{CE} = 1250V, V _{GE} = 0V | - | - | 1 | mA |
| I _{GES} | G-E Leakage Current | V _{GE} = V _{GES} , V _{CE} = 0V | - | - | ±500 | nA |
| On Characteristics | | | | | | |
| V _{GE(th)} | G-E Threshold Voltage | I _C = 25mA, V _{CE} = V _{GE} | 4.5 | 6.0 | 7.5 | V |
| V _{CE(sat)} | Collector to Emitter Saturation Voltage | I _C = 25A, V _{GE} = 15V T _C = 25°C | - | 1.8 | 2.35 | V |
| | | I _C = 25A, V _{GE} = 15V T _C = 125°C | - | 2.05 | - | V |
| | | I _C = 25A, V _{GE} = 15V, T _C = 175°C | - | 2.16 | - | V |
| V _{FM} | Diode Forward Voltage | I _F = 25A, T _C = 25°C | - | 1.7 | 2.4 | V |
| | | I _F = 25A, T _C = 175°C | - | 2.1 | - | V |
| Dynamic Characteristics | | | | | | |
| C _{ies} | Input Capacitance | V _{CE} = 30V, V _{GE} = 0V, f = 1MHz | - | 2150 | - | pF |
| C _{oes} | Output Capacitance | | - | 48 | - | pF |
| C _{res} | Reverse Transfer Capacitance | | - | 36 | - | pF |
| Switching Characteristics | | | | | | |
| t _{d(on)} | Turn-On Delay Time | V _{CC} = 600V, I _C = 25A, R _G = 10Ω, V _{GE} = 15V, Resistive Load, T _C = 25°C | - | 24 | - | ns |
| t _r | Rise Time | | - | 250 | - | ns |
| t _{d(off)} | Turn-Off Delay Time | | - | 502 | - | ns |
| t _f | Fall Time | | - | 138 | - | ns |
| E _{on} | Turn-On Switching Loss | | - | 1085 | - | μJ |
| E _{off} | Turn-Off Switching Loss | | - | 580 | - | μJ |
| E _{ts} | Total Switching Loss | - | 1665 | - | μJ | |
| t _{d(on)} | Turn-On Delay Time | V _{CC} = 600V, I _C = 25A, R _G = 10Ω, V _{GE} = 15V, Resistive Load,, T _C = 175°C | - | 21.2 | - | ns |
| t _r | Rise Time | | - | 304 | - | ns |
| t _{d(off)} | Turn-Off Delay Time | | - | 490 | - | ns |
| t _f | Fall Time | | - | 232 | - | ns |
| E _{on} | Turn-On Switching Loss | | - | 1310 | - | μJ |
| E _{off} | Turn-Off Switching Loss | | - | 952 | - | μJ |
| E _{ts} | Total Switching Loss | - | 2262 | - | μJ | |
| Q _g | Total Gate Charge | V _{CE} = 600V, I _C = 25A, V _{GE} = 15V | - | 204 | - | nC |
| Q _{ge} | Gate to Emitter Charge | | - | 15 | - | nC |
| Q _{gc} | Gate to Collector Charge | | - | 103 | - | nC |

Typical Performance Characteristics

Figure 1. Typical Output Characteristics

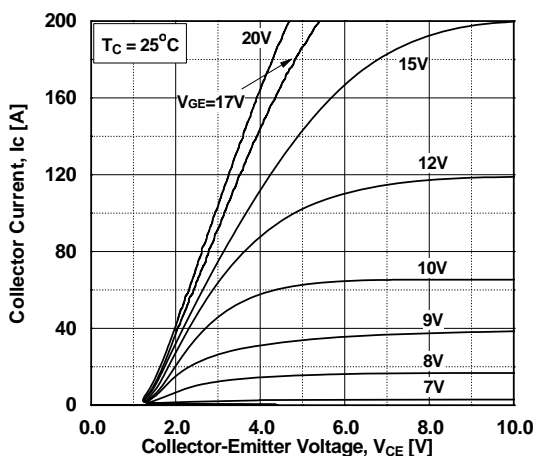

Figure 2. Typical Output Characteristics

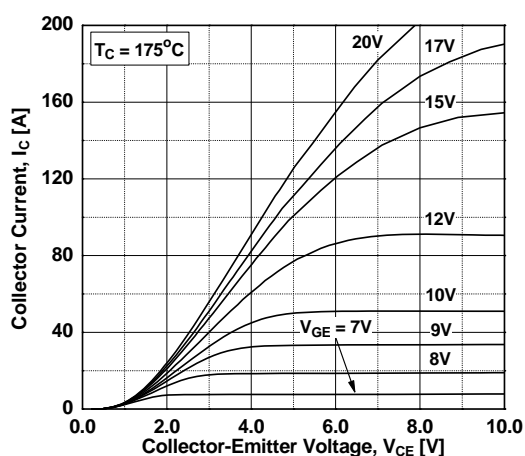

Figure 3. Typical Saturation Voltage Characteristics

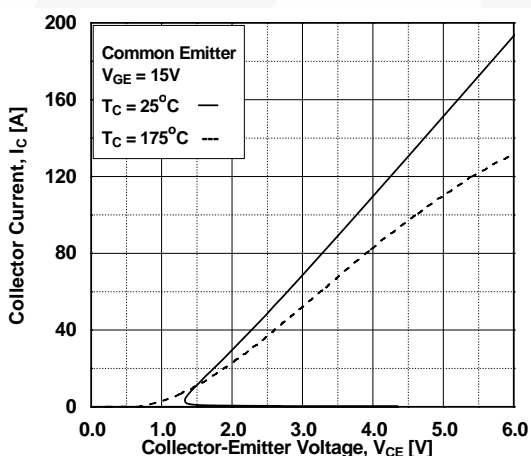

Figure 4. Transfer Characteristics

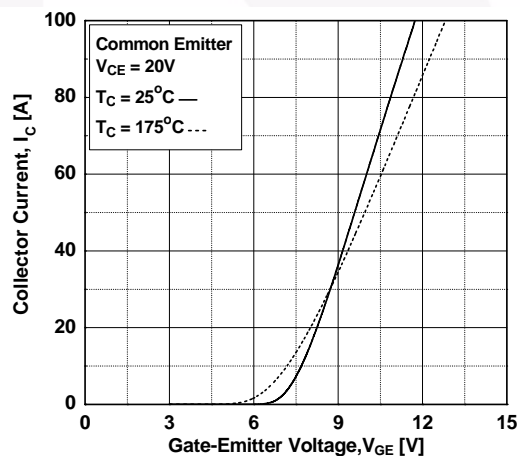

Figure 5. Saturation Voltage vs. Case Temperature at Variant Current Level

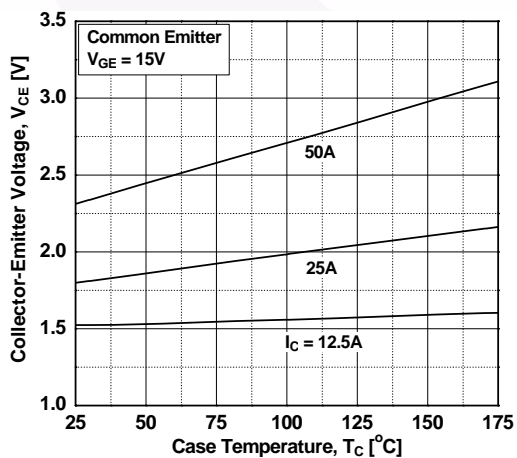
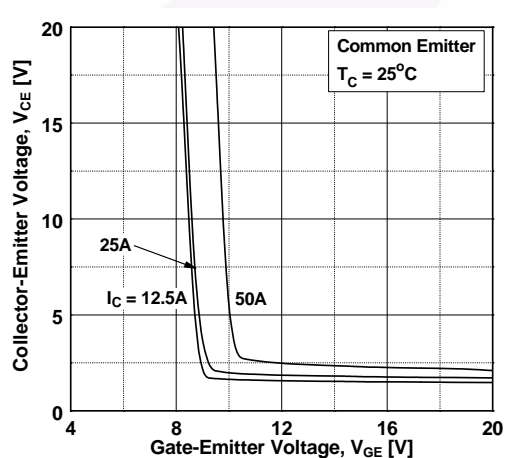

Figure 6. Saturation Voltage vs. Vge



Typical Performance Characteristics

Figure 7. Saturation Voltage vs. V_{GE}

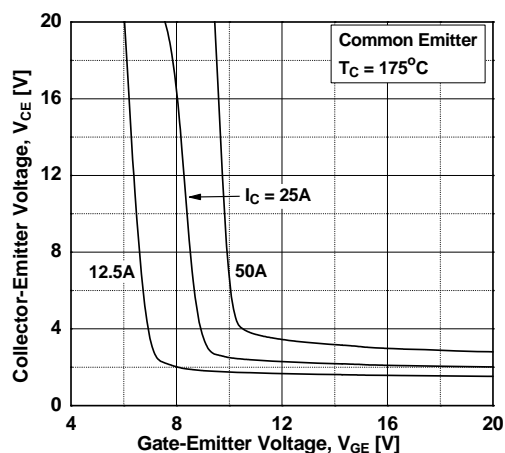

Figure 8. Capacitance Characteristics

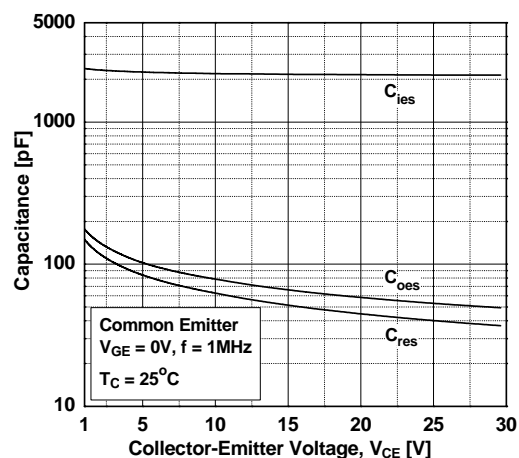

Figure 9. Gate charge Characteristics

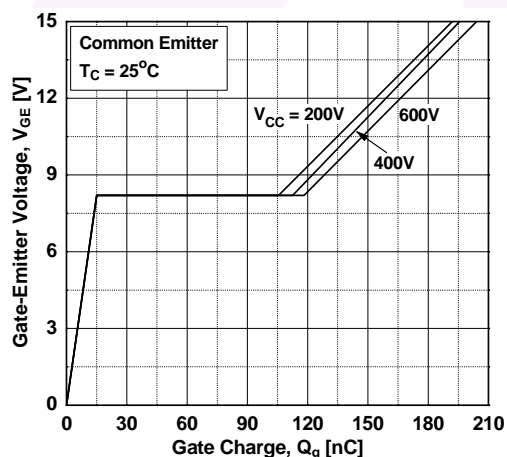

Figure 10. SOA Characteristics

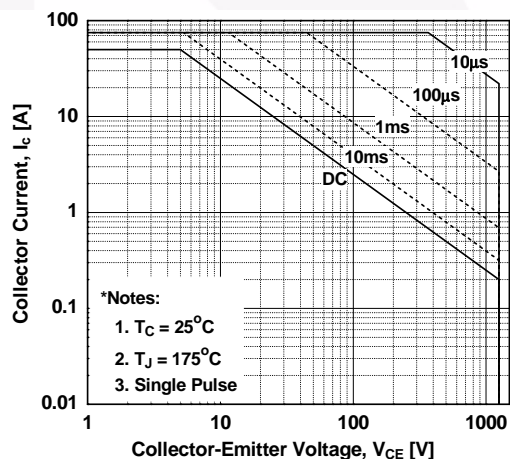

Figure 11. Turn-on Characteristics vs. Gate Resistance

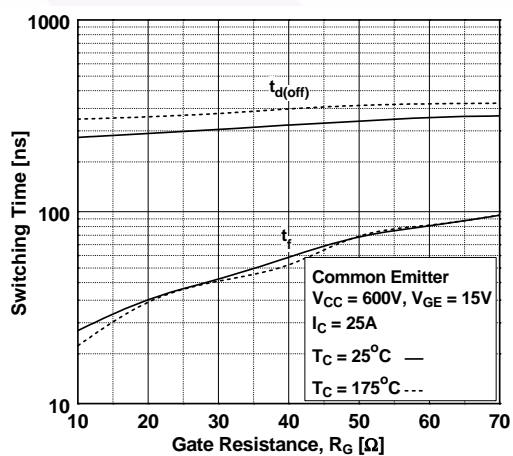
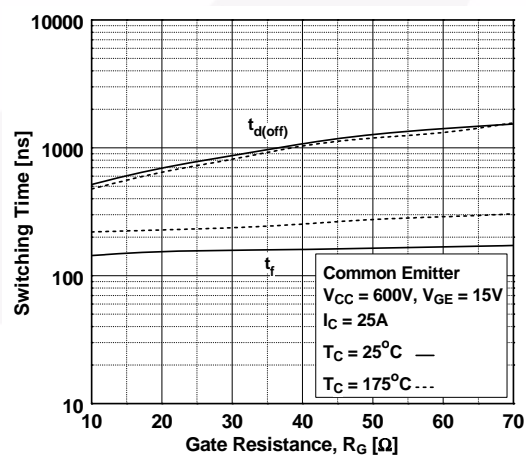

Figure 12. Turn-off Characteristics vs. Gate Resistance



Typical Performance Characteristics

Figure 13. Turn-on Characteristics vs. Collector Current

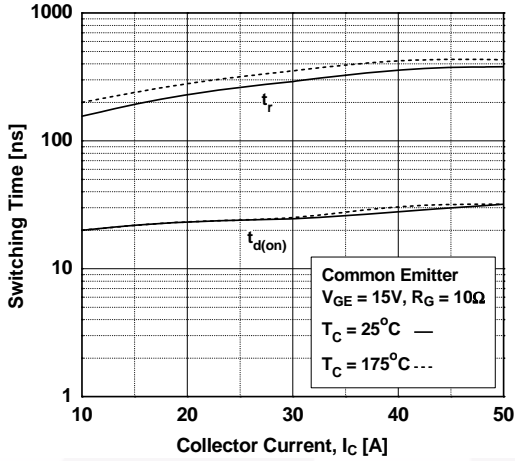

Figure 14. Turn-off Characteristics vs. Collector Current

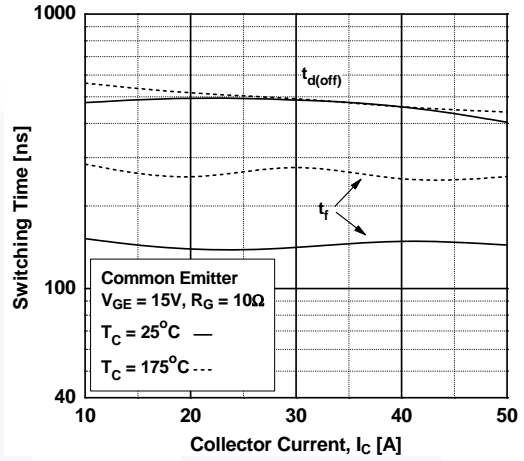

Figure 15. Switching Loss vs. Gate Resistance

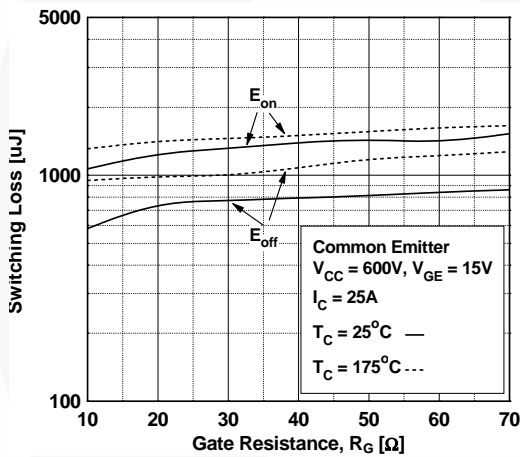

Figure 16. Switching Loss vs. Collector Current

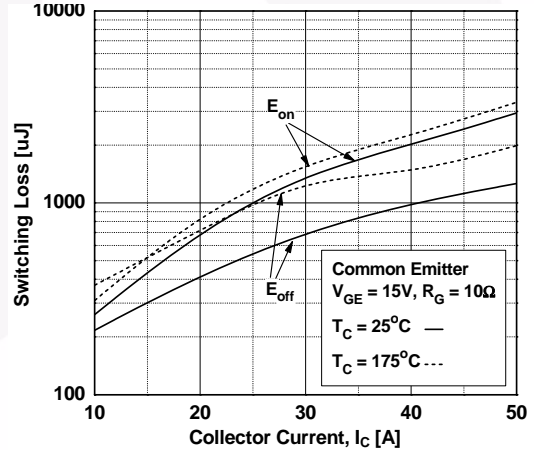

Figure 17. Turn off Switching SOA Characteristics

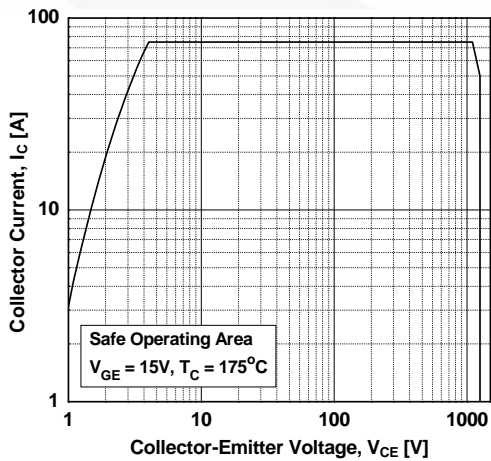
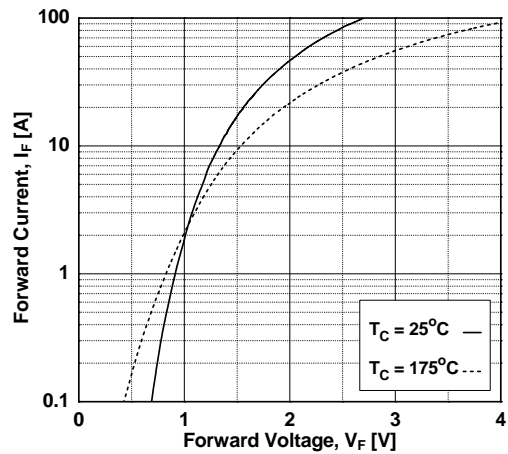
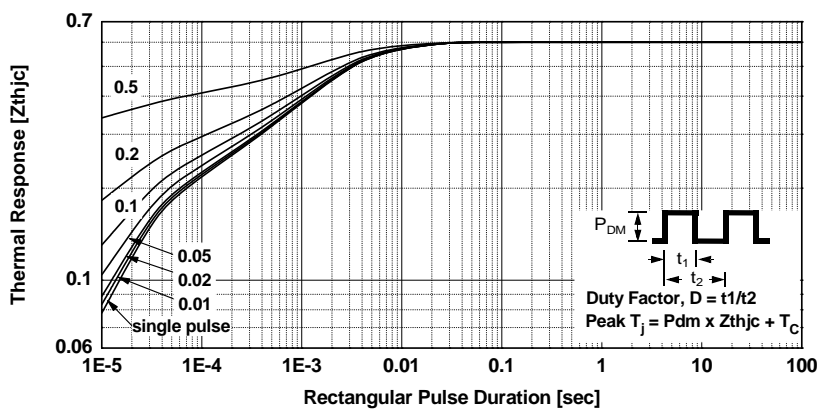

Figure 18. Forward Characteristics



Typical Performance Characteristics

Figure 19. Transient Thermal Impedance of IGBT



Mechanical Dimensions

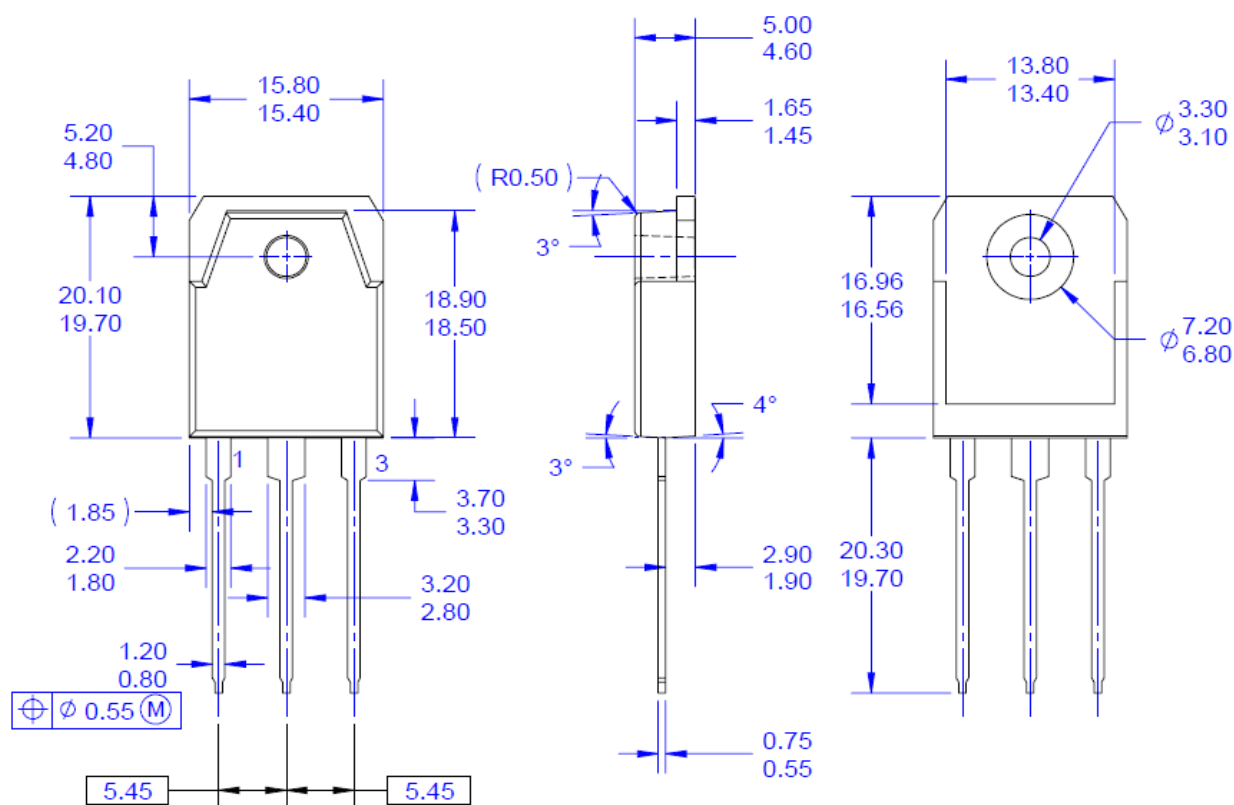

NOTES: UNLESS OTHERWISE SPECIFIED

- A) THIS PACKAGE CONFORMS TO EIAJ SC-65 PACKAGING STANDARD.
- B) ALL DIMENSIONS ARE IN MILLIMETERS.
- C) DIMENSION AND TOLERANCING PER ASME14.5
- D) DIMENSIONS ARE EXCLUSIVE OF BURRS, MOLD FLASH, AND TIE BAR EXTRUSIONS.
- E) THIS PACKAGE IS INTENDED ONLY FOR T03PN.
- F) DRAWING FILE NAME: T03P03AREV4.

Figure 20. TO-3P 3L - 3LD, T03, PLASTIC, EIAJ SC-65

Package drawings are provided as a service to customers considering Fairchild components. Drawings may change in any manner without notice. Please note the revision and/or date on the drawing and contact a Fairchild Semiconductor representative to verify or obtain the most recent revision. Package specifications do not expand the terms of Fairchild's worldwide terms and conditions, specifically the warranty therein, which covers Fairchild products.





Always visit Fairchild Semiconductor's online packaging area for the most recent package drawings:

http://www.fairchildsemi.com/package/packageDetails.html?id=PN_TT3P0-003

Dimensions in Millimeters

TRADEMARKS

The following includes registered and unregistered trademarks and service marks, owned by Fairchild Semiconductor and/or its global subsidiaries, and is not intended to be an exhaustive list of all such trademarks.

- | | | | |
|--|---|---|--|
| AccuPower™ | F-PFST™ | PowerTrench® | Sync-Lock™ |
| AX-CAP®* | FRFET® | PowerXS™ |  SYSTEM®* |
| BitSiC™ | Global Power Resource SM | Programmable Active Droop™ | TinyBoost® |
| Build it Now™ | GreenBridge™ | QFET® | TinyBuck® |
| CorePLUS™ | Green FPS™ | QS™ | TinyCalc™ |
| CorePOWER™ | Green FPS™ e-Series™ | Quiet Series™ | TinyLogic® |
| CROSSVOLT™ | Gmax™ | RapidConfigure™ | TINYOPTO™ |
| CTL™ | GTO™ | | TinyPower™ |
| Current Transfer Logic™ | IntelliMAX™ |  Saving our world, 1mW/W/kW at a time™ | TinyPWM™ |
| DEUXPEED® | ISOPLANAR™ | SignalWise™ | TinyWire™ |
| Dual Cool™ | Marking Small Speakers Sound Louder and Better™ | SmartMax™ | TranSiC™ |
| EcoSPARK® | MegaBuck™ | SMART START™ | TriFault Detect™ |
| EfficientMax™ | MICROCOUPLER™ | Solutions for Your Success™ | TRUECURRENT®* |
| ESBC™ | MicroFET™ | SPM® | µSerDes™ |
|  Fairchild® | MicroPak™ | STEALTH™ |  SerDes® |
| Fairchild Semiconductor® | MicroPak2™ | SuperFET® | UHC® |
| FACT Quiet Series™ | MillerDrive™ | SuperSOT™-3 | Ultra FRFET™ |
| FACT® | MotionMax™ | SuperSOT™-6 | UniFET™ |
| FAST® | mWSaver® | SuperSOT™-8 | VCX™ |
| FastvCore™ | OptoHiT™ | SupreMOS® | VisualMax™ |
| FETBench™ | OPTOLOGIC® | SyncFET™ | VoltagePlus™ |
| FPS™ | OPTOPLANAR® | | XS™ |

*Trademarks of System General Corporation, used under license by Fairchild Semiconductor.

DISCLAIMER

FAIRCHILD SEMICONDUCTOR RESERVES THE RIGHT TO MAKE CHANGES WITHOUT FURTHER NOTICE TO ANY PRODUCTS HEREIN TO IMPROVE RELIABILITY, FUNCTION, OR DESIGN. FAIRCHILD DOES NOT ASSUME ANY LIABILITY ARISING OUT OF THE APPLICATION OR USE OF ANY PRODUCT OR CIRCUIT DESCRIBED HEREIN; NEITHER DOES IT CONVEY ANY LICENSE UNDER ITS PATENT RIGHTS, NOR THE RIGHTS OF OTHERS. THESE SPECIFICATIONS DO NOT EXPAND THE TERMS OF FAIRCHILD'S WORLDWIDE TERMS AND CONDITIONS, SPECIFICALLY THE WARRANTY THEREIN, WHICH COVERS THESE PRODUCTS.

LIFE SUPPORT POLICY

FAIRCHILD'S PRODUCTS ARE NOT AUTHORIZED FOR USE AS CRITICAL COMPONENTS IN LIFE SUPPORT DEVICES OR SYSTEMS WITHOUT THE EXPRESS WRITTEN APPROVAL OF FAIRCHILD SEMICONDUCTOR CORPORATION.

As used here in:

- Life support devices or systems are devices or systems which, (a) are intended for surgical implant into the body or (b) support or sustain life, and (c) whose failure to perform when properly used in accordance with instructions for use provided in the labeling, can be reasonably expected to result in a significant injury of the user.
- A critical component in any component of a life support, device, or system whose failure to perform can be reasonably expected to cause the failure of the life support device or system, or to affect its safety or effectiveness.

ANTI-COUNTERFEITING POLICY

Fairchild Semiconductor Corporation's Anti-Counterfeiting Policy. Fairchild's Anti-Counterfeiting Policy is also stated on our external website, www.fairchildsemi.com, under Sales Support. Counterfeiting of semiconductor parts is a growing problem in the industry. All manufactures of semiconductor products are experiencing counterfeiting of their parts. Customers who inadvertently purchase counterfeit parts experience many problems such as loss of brand reputation, substandard performance, failed application, and increased cost of production and manufacturing delays. Fairchild is taking strong measures to protect ourselves and our customers from the proliferation of counterfeit parts. Fairchild strongly encourages customers to purchase Fairchild parts either directly from Fairchild or from Authorized Fairchild Distributors who are listed by country on our web page cited above. Products customers buy either from Fairchild directly or from Authorized Fairchild Distributors are genuine parts, have full traceability, meet Fairchild's quality standards for handling and storage and provide access to Fairchild's full range of up-to-date technical and product information. Fairchild and our Authorized Distributors will stand behind all warranties and will appropriately address and warranty issues that may arise. Fairchild will not provide any warranty coverage or other assistance for parts bought from Unauthorized Sources. Fairchild is committed to combat this global problem and encourage our customers to do their part in stopping this practice by buying direct or from authorized distributors.

PRODUCT STATUS DEFINITIONS

Definition of Terms

| Datasheet Identification | Product Status | Definition |
|--------------------------|-----------------------|---|
| Advance Information | Formative / In Design | Datasheet contains the design specifications for product development. Specifications may change in any manner without notice. |
| Preliminary | First Production | Datasheet contains preliminary data; supplementary data will be published at a later date. Fairchild Semiconductor reserves the right to make changes at any time without notice to improve design. |
| No Identification Needed | Full Production | Datasheet contains final specifications. Fairchild Semiconductor reserves the right to make changes at any time without notice to improve the design. |
| Obsolete | Not In Production | Datasheet contains specifications on a product that is discontinued by Fairchild Semiconductor. The datasheet is for reference information only. |

Rev. I66