

THIS DRAWING IS UNPUBLISHED. RELEASED FOR PUBLICATION 2006
 © COPYRIGHT 2006 ALL RIGHTS RESERVED.

LOC		DIST		REVISIONS			DATE	DWN	APVD
P	LTR	DESCRIPTION							
J		CI	REVISED PER ECO-11-005030			2APR2011	RK	HMR	

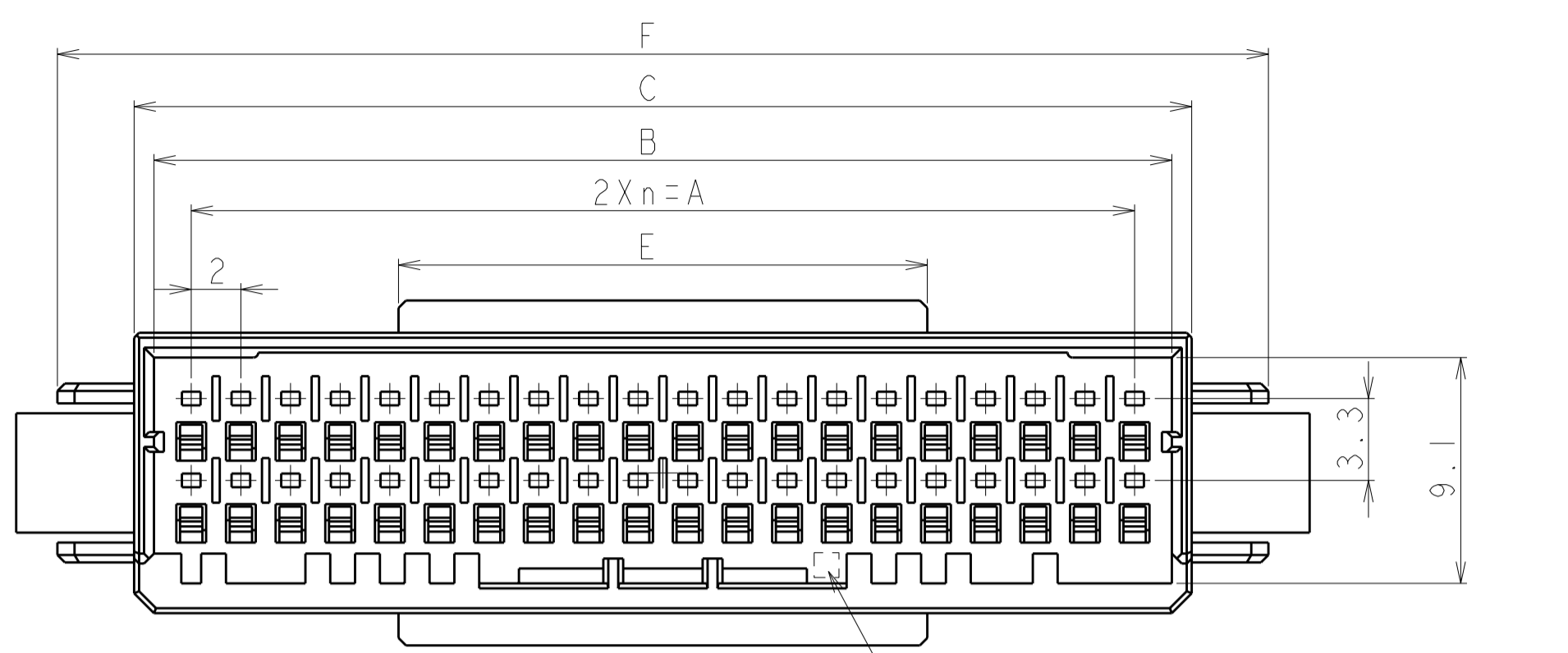

CAVITY MARK
(ALPHABET: CAPITAL LETTER)

40POS(X-KEY): 1-1903128-0

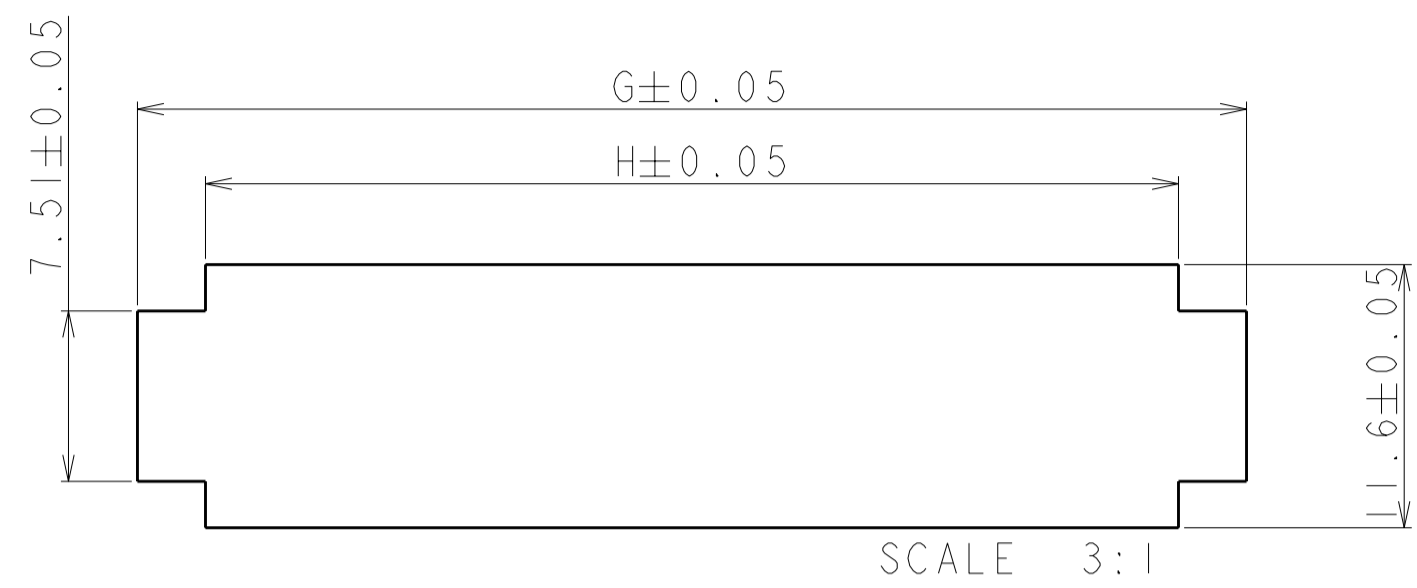

RECOMMENDED PANEL LAYOUT
(APPLICABLE PANEL THICKNESS : 0.8, 1.0, 1.6, 2.0)

パネル加工推奨寸法図
(適用パネル厚 : 0.8, 1.0, 1.6, 2.0)

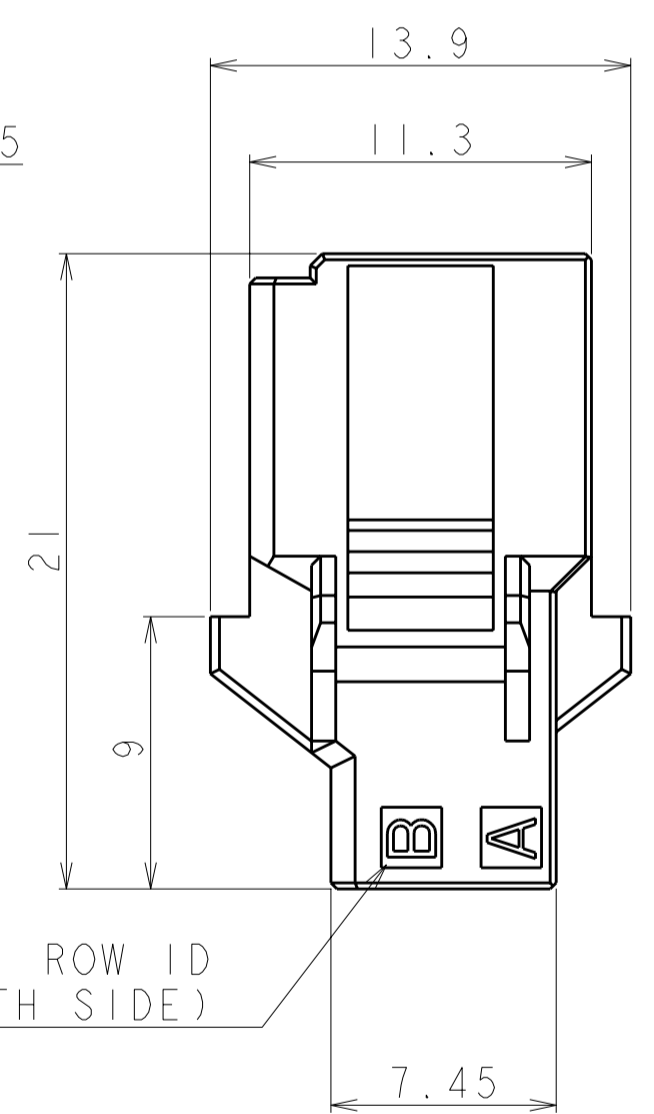
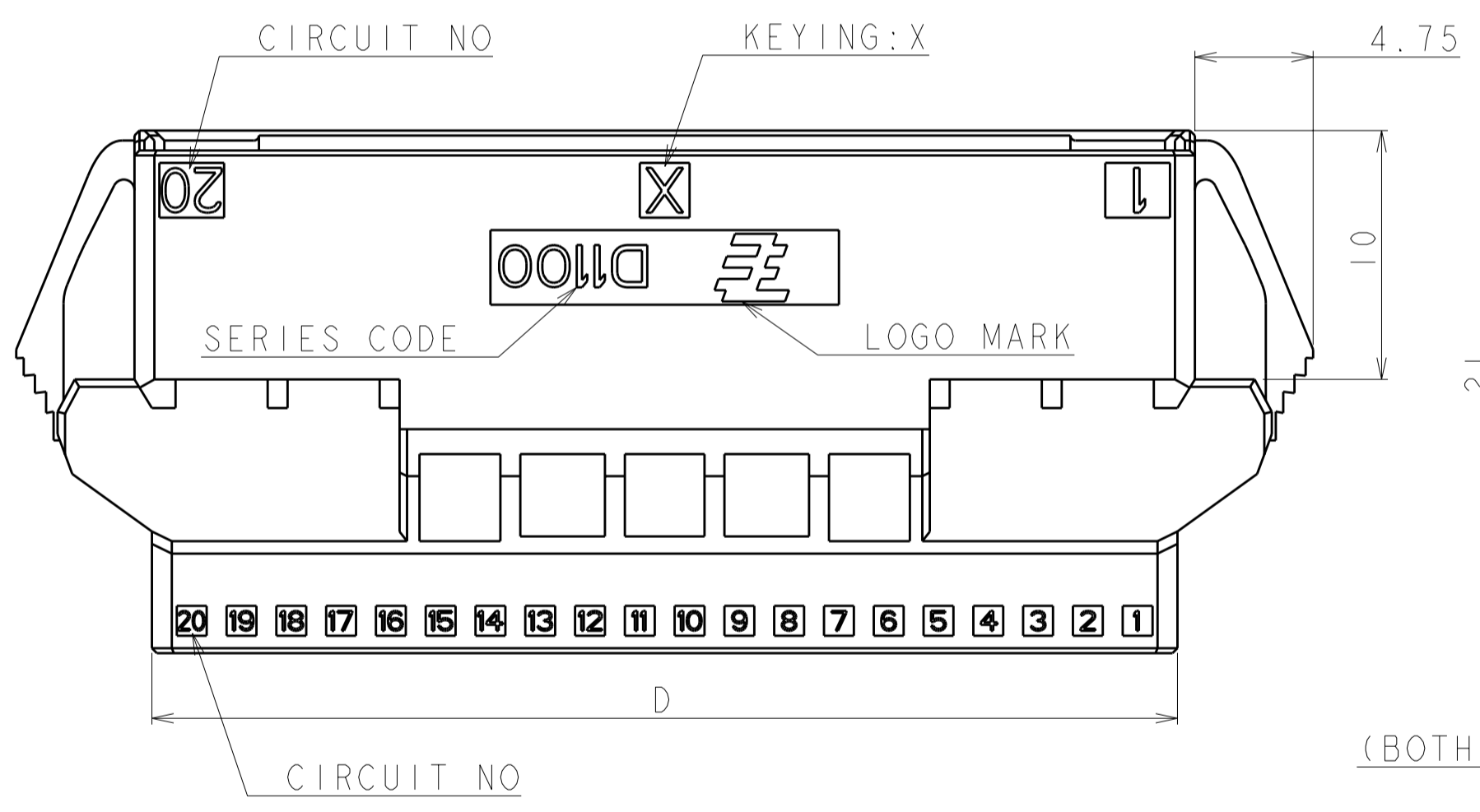

1. MATERIAL: GLASS FILLED THERMO PLASTIC POLYESTER(94V-0), COLOR: BLACK
 2. THE SHAPE, SIZE AND POSITION OF THE CHARACTER SHOW THE OUTLINE. THEY DON'T SHOW DETAILS.

1. 材料: ガラス入り熱可塑性ポリエステル樹脂(94V-0), 色: 黒
 2. 文字の形状、大きさ、および位置については、大略を示すものであり、詳細を示すものではありません。

AS SHOWN 40POS : 1-1903128-0

40	X	19	38.0	41.0	42.6	41.2	21.3	48.78	48.9	42.9	1-1903128-0
34	X	16	32.0	35.0	36.6	35.2	18.3	42.78	42.9	36.9	1-1903128-7
32	X	15	30.0	33.0	34.6	33.2	17.3	40.78	40.9	34.9	1-1903128-6
28	X	13	26.0	29.0	30.6	29.2	15.3	36.78	36.9	30.9	1-1903128-4
26	X	12	24.0	27.0	28.6	27.2	14.3	34.78	34.9	28.9	1-1903128-3
22	X	10	20.0	23.0	24.6	23.2	13.2	30.78	30.9	24.9	1-1903128-1
POS	KEY	n	A	B	C	D	E	F	G	H	PART NO

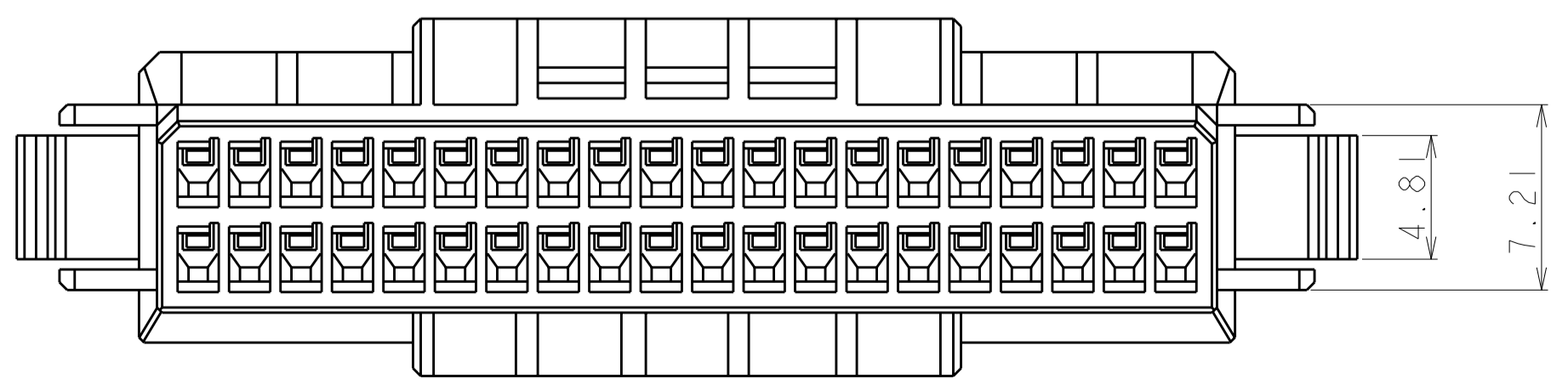

THIS DRAWING IS A CONTROLLED DOCUMENT.

DIMENSIONS: 単位: 概 mm	TOLERANCES UNLESS OTHERWISE SPECIFIED: 一般公差 ±0.3, ±3° 0-PLC ± 1-PLC ± 2-PLC ± 3-PLC ± 4-PLC ± ANGLES ± FINISH 仕上	DWN M. MAEBASHI 17APR2006 CHK T. KUDO 17APR2006 APVD D. MITSUGI 17APR2006 PRODUCT SPEC 108-78268, 78298 APPLICATION SPEC 114-5377 WEIGHT	NAME DYNAMIC D1100D 2.0mm PITCH TAB HSG, PANEL MOUNT TYPE 22-40 POS
MATERIAL 材料		SIZE A2 CAGE CODE 00779 DRAWING NO. C-1903128 RESTRICTED TO	SCALE 4:1 SHEET 1 OF 3 REV CI

CUSTOMER DRAWING

THIS DRAWING IS UNPUBLISHED. RELEASED FOR PUBLICATION 2006
 © COPYRIGHT 2006 ALL RIGHTS RESERVED.

LOC	DIST	REVISIONS		
J		P	LTR	DESCRIPTION
		-	-	SEE SHEET 1
			DATE	DWN
				APVD

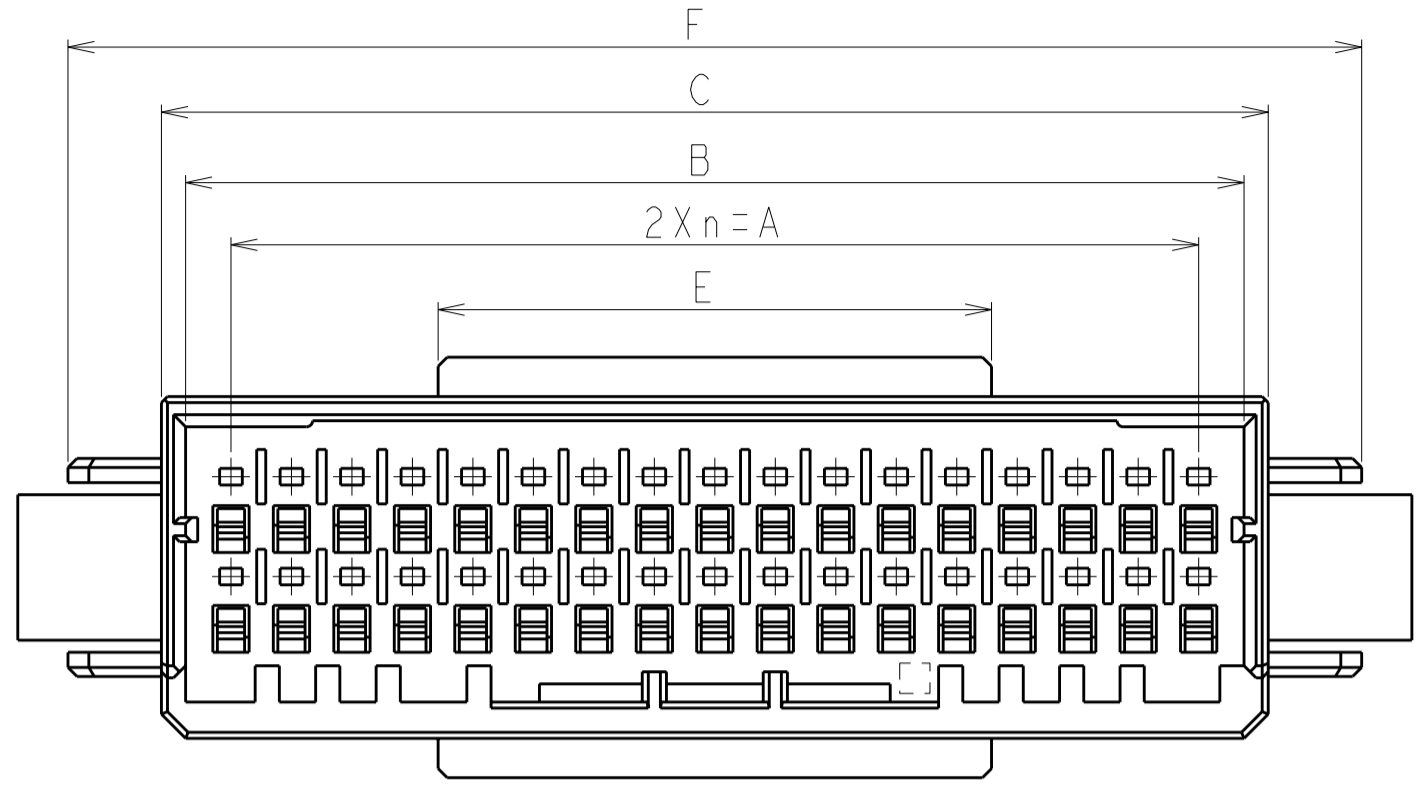

34POS(X-KEY):1-1903128-7

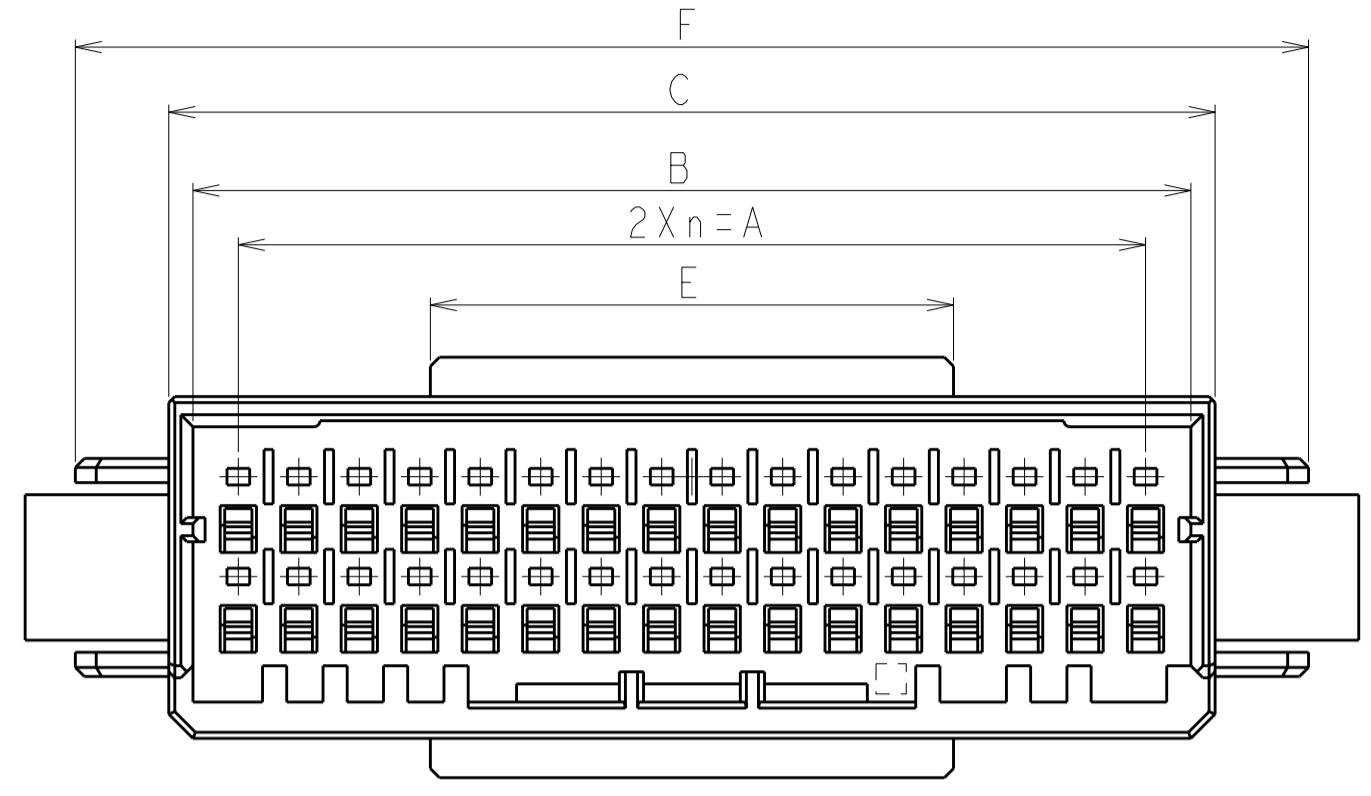

32POS(X-KEY):1-1903128-6

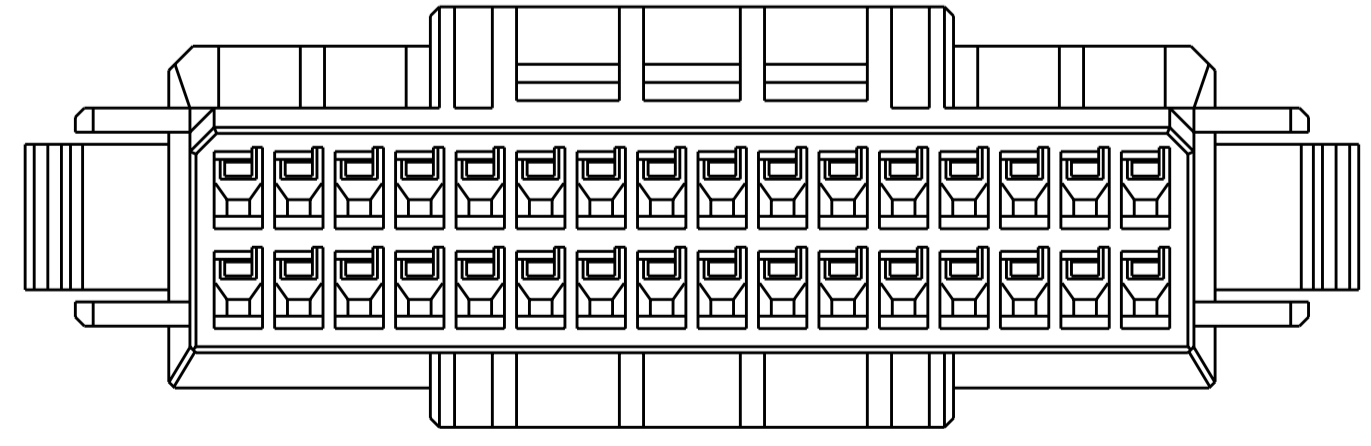
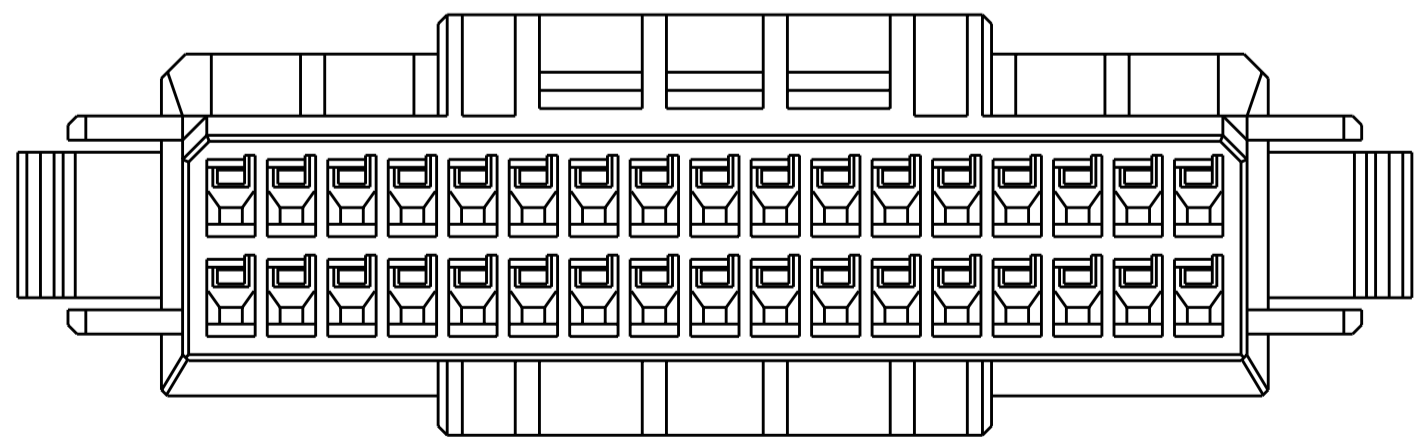
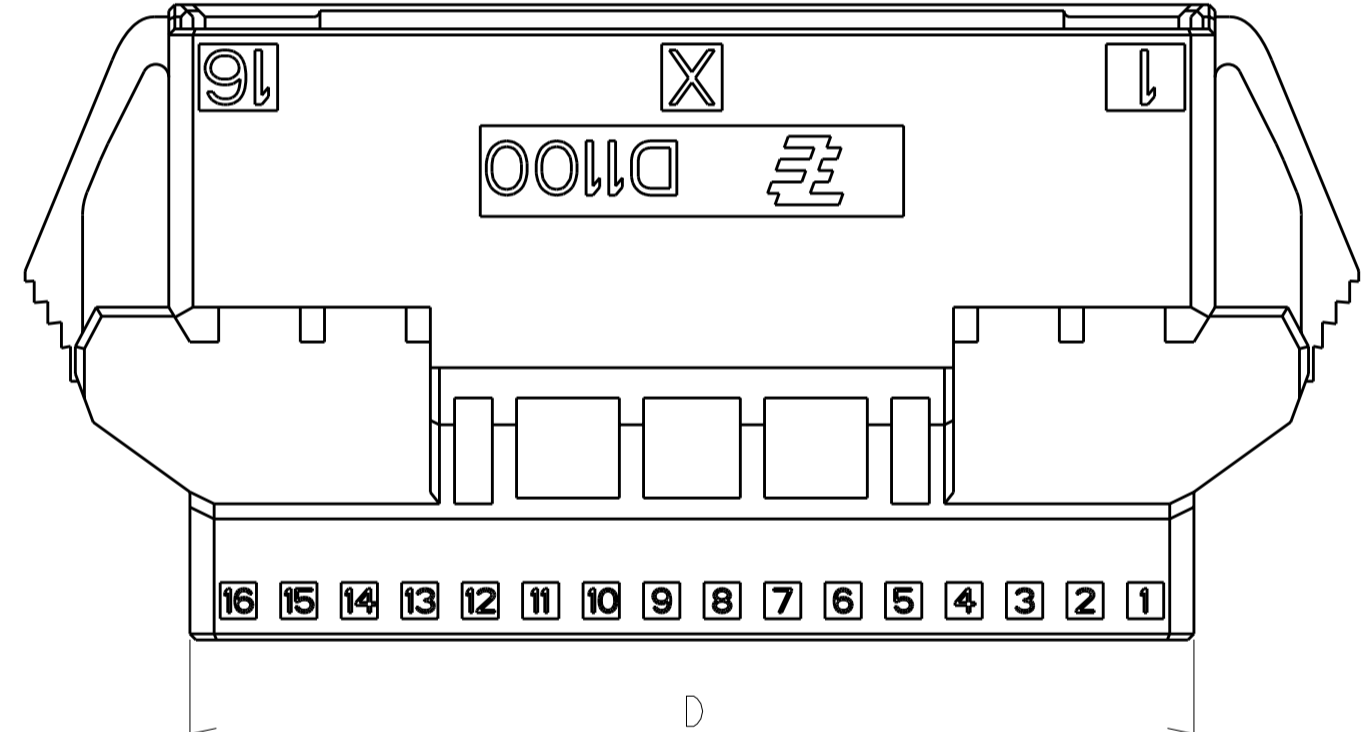
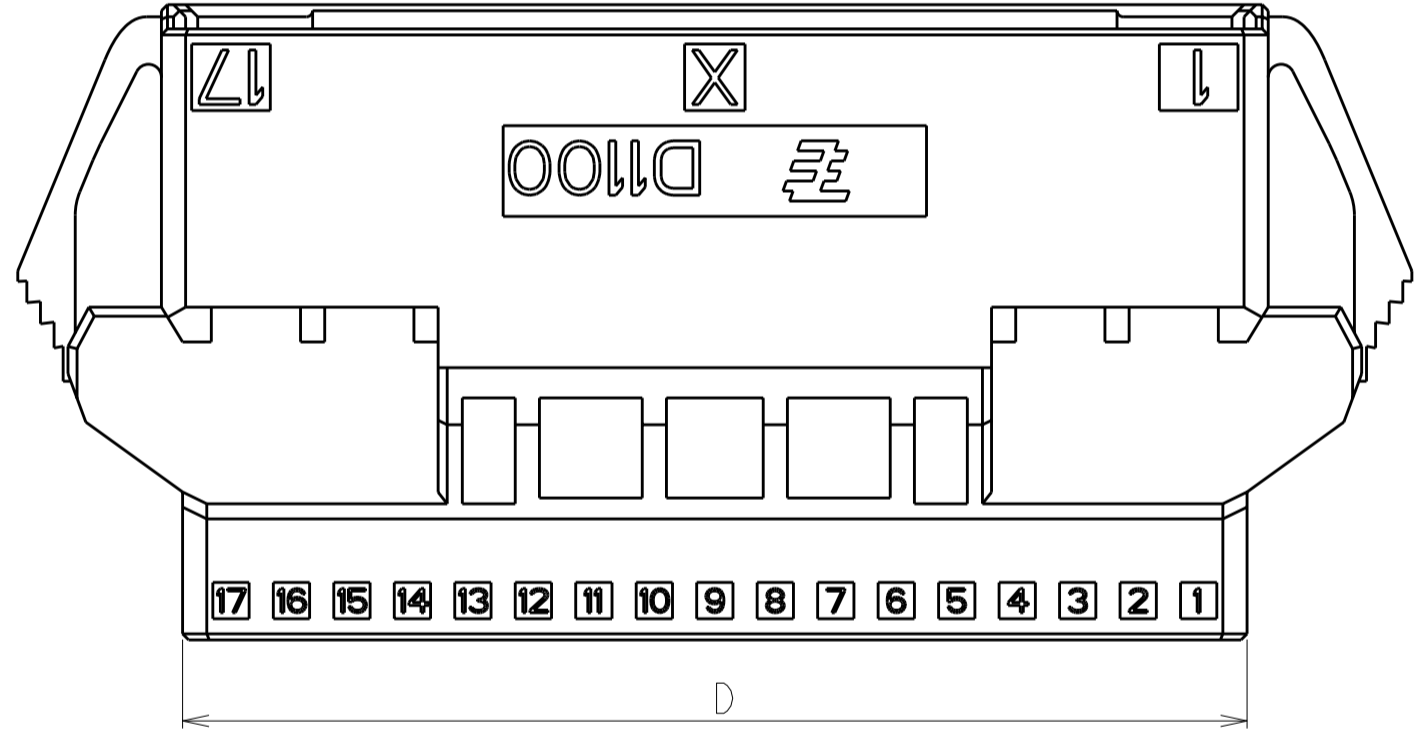

THIS DRAWING IS A CONTROLLED DOCUMENT.		DWN M. MAEBASHI 17APR2006	 TE Connectivity	NAME DYNAMIC D1100D 2.0mm PITCH TAB HSG, PANEL MOUNT TYPE 22-40 POS
DIMENSIONS: 单位: 毫米 mm		CHK T. KUDO 17APR2006		
TOLERANCES UNLESS OTHERWISE SPECIFIED: 一般公差 0 PLC ± 1 PLC ± 2 PLC ± 3 PLC ± 4 PLC ± ANGLES ± FINISH 仕上		APVD D. MIISUGI 17APR2006	SIZE A200779	RESTRICTED TO
MATERIAL 材料		PRODUCT SPEC 108-78268,78298	DRAWING NO C-1903128	
		APPLICATION SPEC 取付適用規格 114-5377	SCALE 4:1	SHEET 2 OF 3
		WEIGHT	CUSTOMER DRAWING	REV C1

THIS DRAWING IS UNPUBLISHED. RELEASED FOR PUBLICATION 2006
 © COPYRIGHT 2006 ALL RIGHTS RESERVED.

LOC	DIST	REVISIONS					
J		P	LTR	DESCRIPTION	DATE	DWN	APVD
		-		SEE SHEET 1			

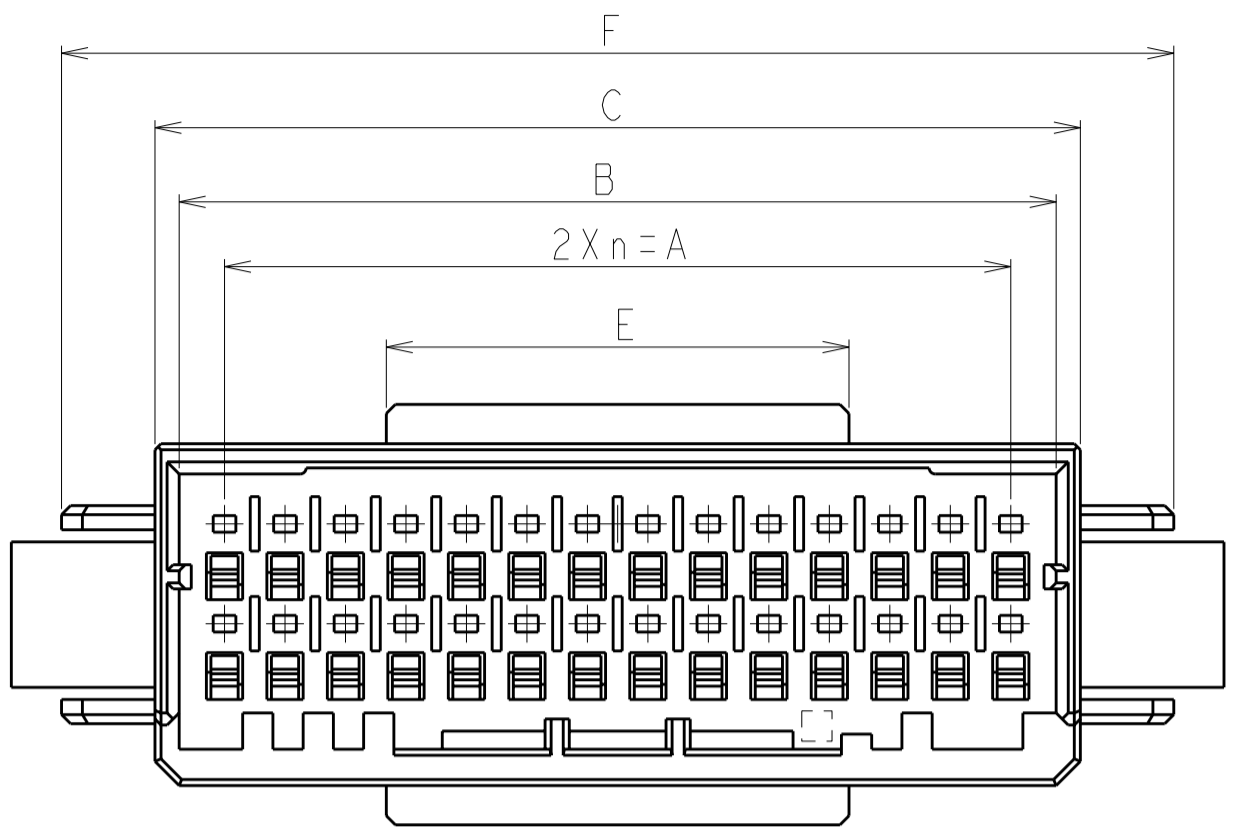

28POS(X-KEY): 1-1903128-4

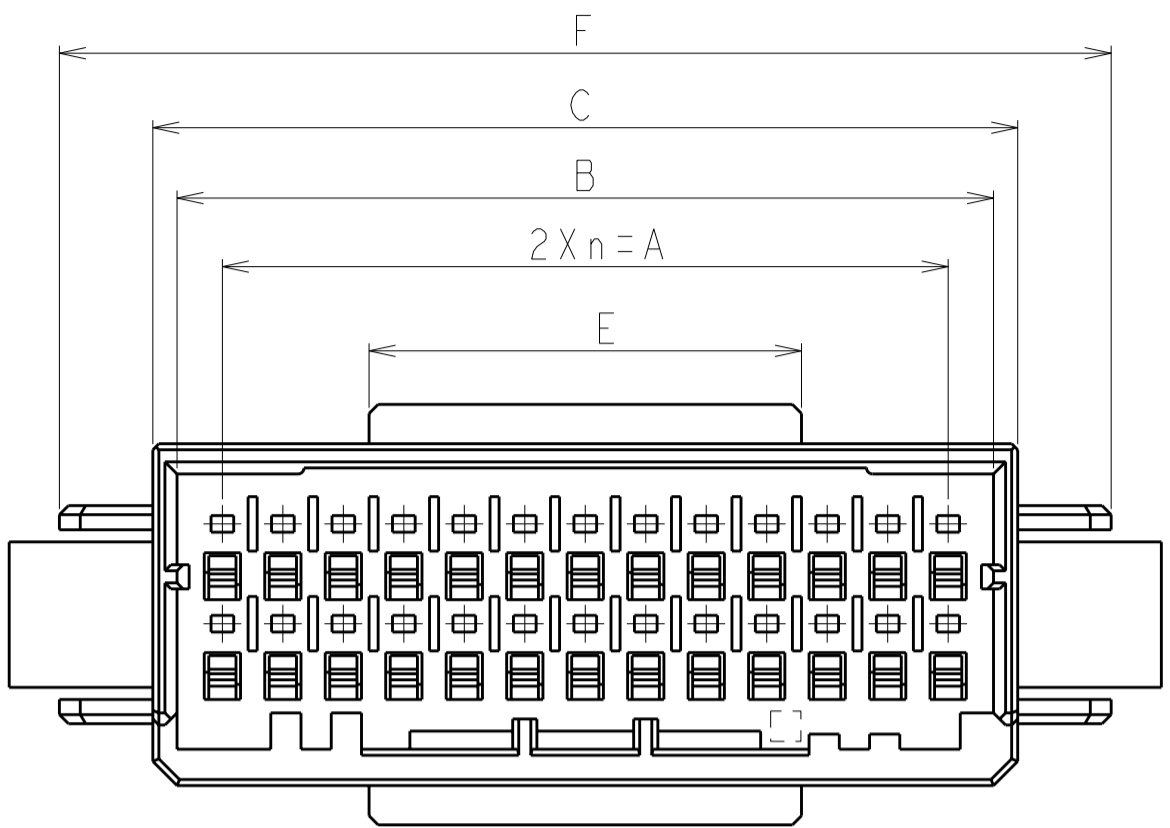

26POS(X-KEY): 1-1903128-3

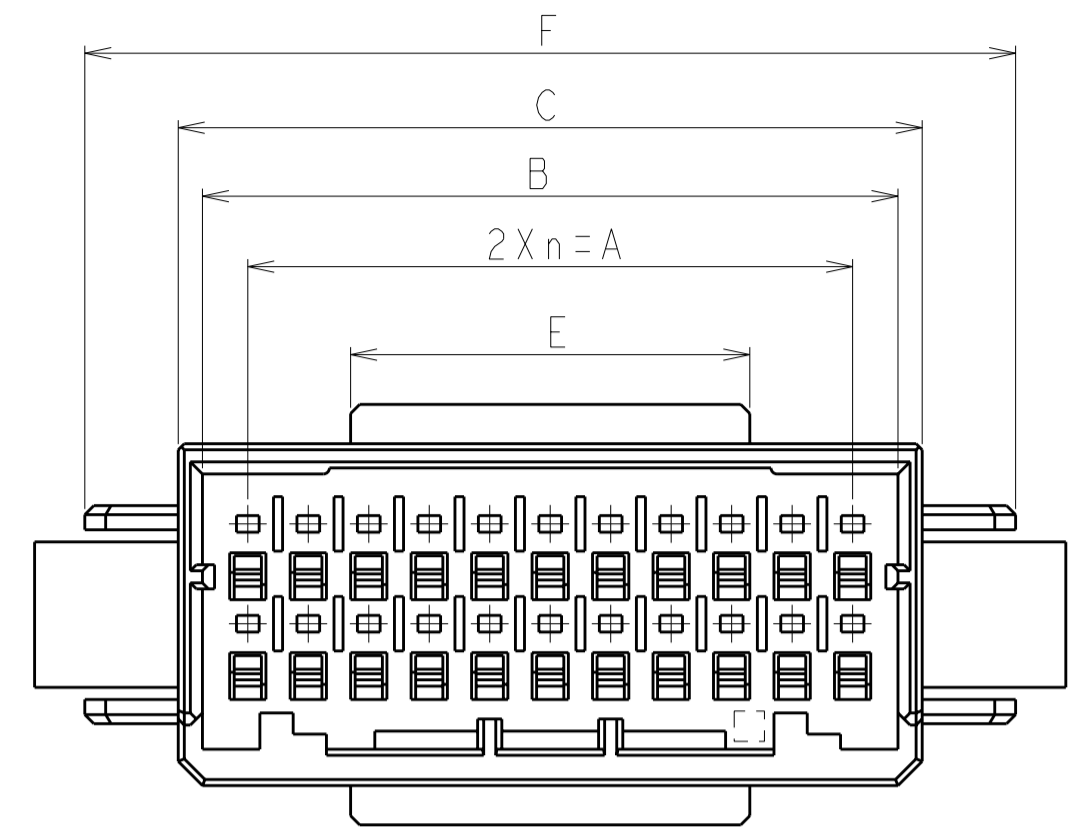

22POS(X-KEY): 1-1903128-1

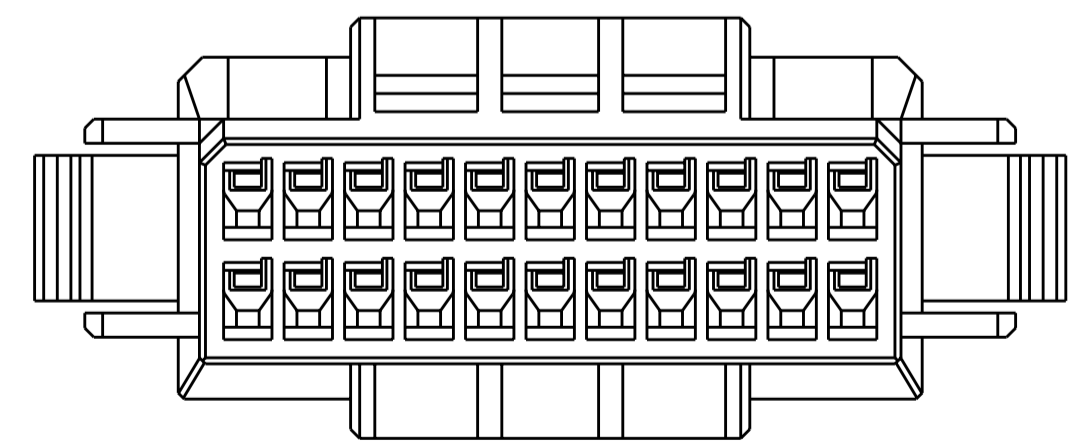
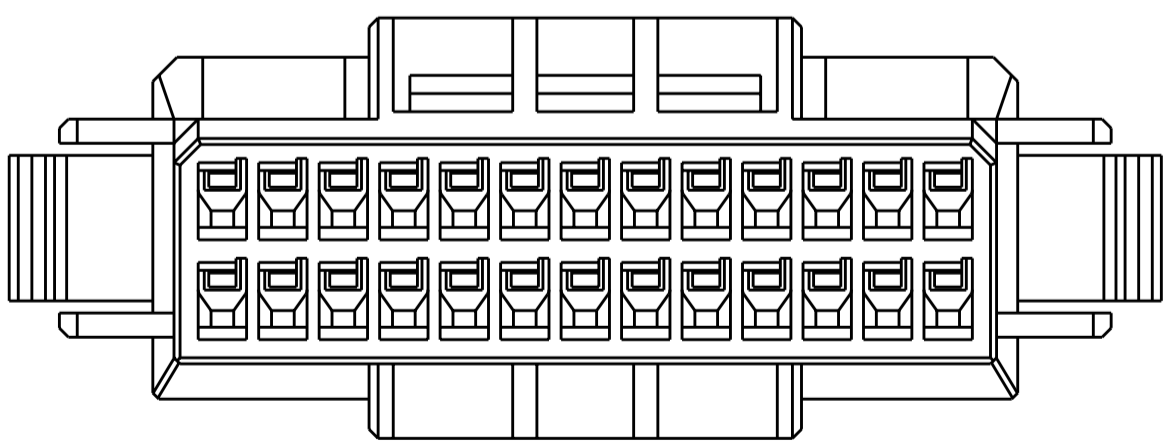
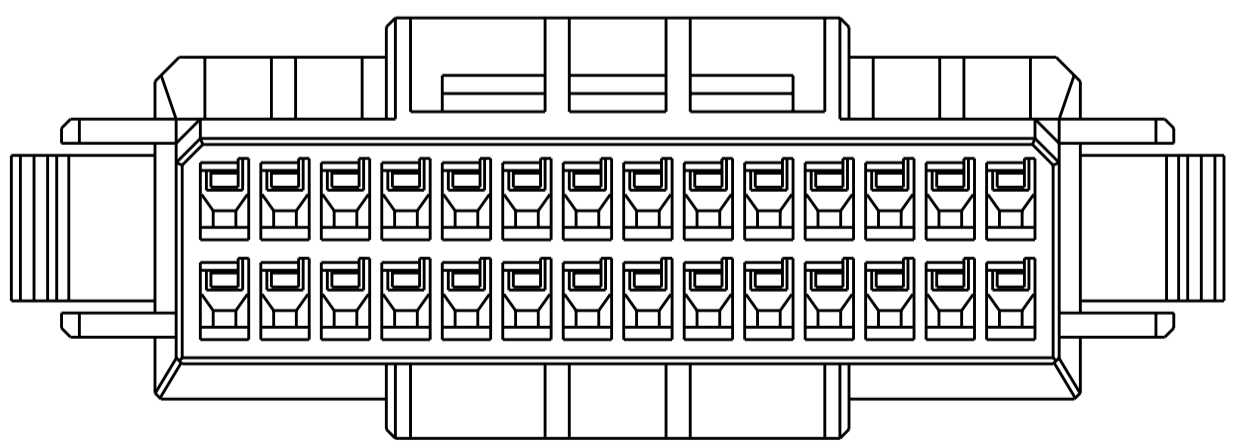
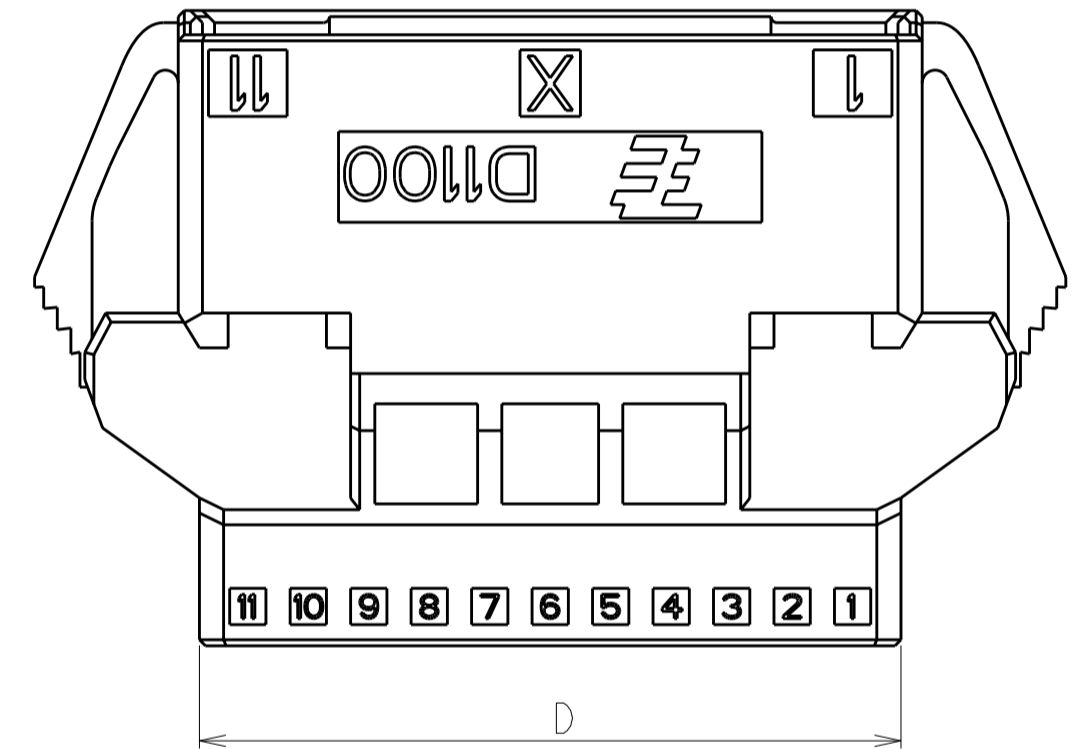
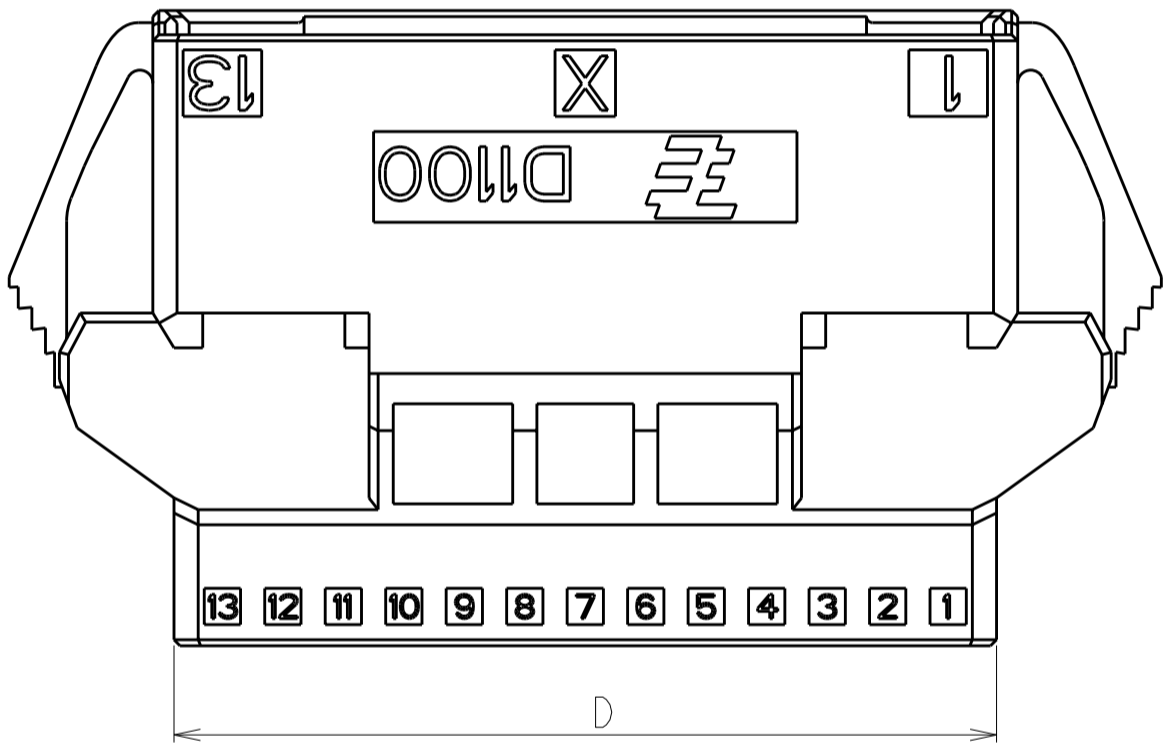
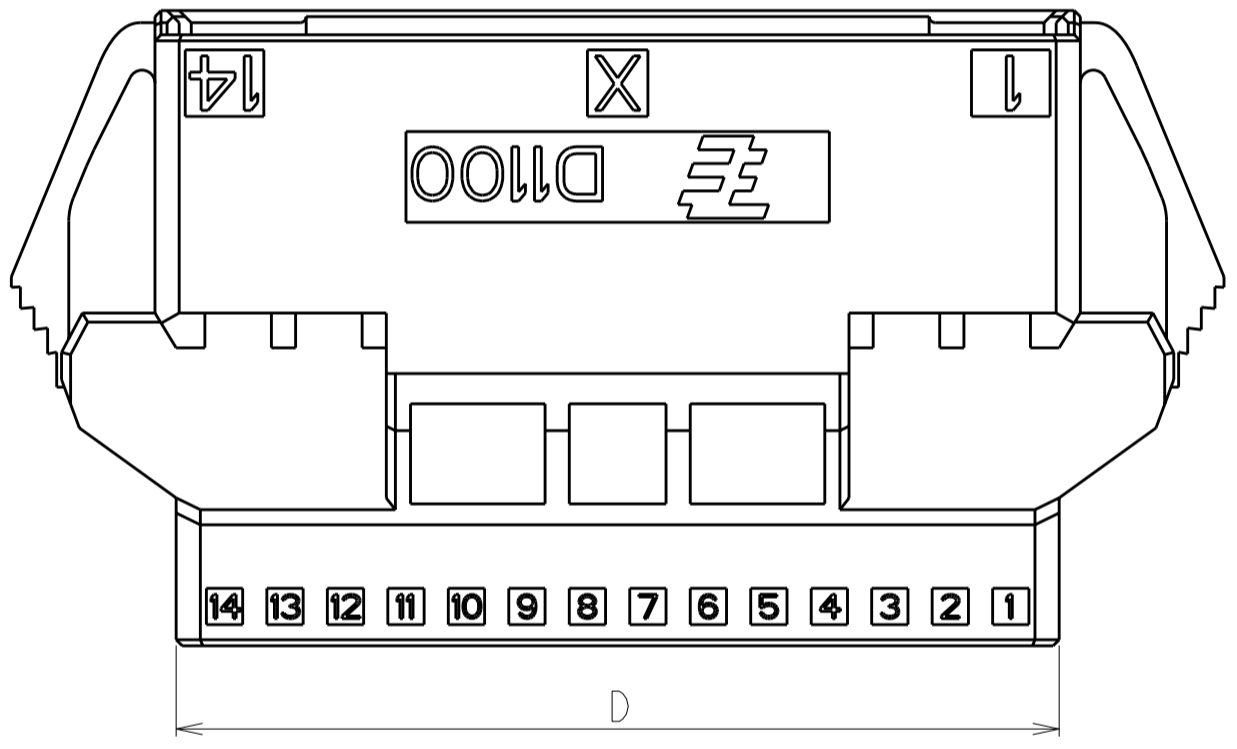

THIS DRAWING IS A CONTROLLED DOCUMENT.		DWN M. MAEBASHI 17APR2006	TE Connectivity DYNAMIC D1100D 2.0mm PITCH TAB HSG, PANEL MOUNT TYPE 22-40 POS	
DIMENSIONS: 単位: 概 mm		CHK T. KUDO 17APR2006		
TOLERANCES UNLESS OTHERWISE SPECIFIED: 一般公差 0 PLC ± 1 PLC ± 2 PLC ± 3 PLC ± 4 PLC ± ANGLES ± FINISH 仕上		APVD D. MITSUGI 17APR2006	NAME D. MITSUGI	RESTRICTED TO
MATERIAL 材料		PRODUCT SPEC 製品規格 108-78268, 78298	APPLICATION SPEC 取付適用規格 114-5377	SIZE A2
		WEIGHT	CAGE CODE A200779	DRAWING NO C-1903128
		CUSTOMER DRAWING	SCALE 4:1	SHEET 3 OF 3 REV C1