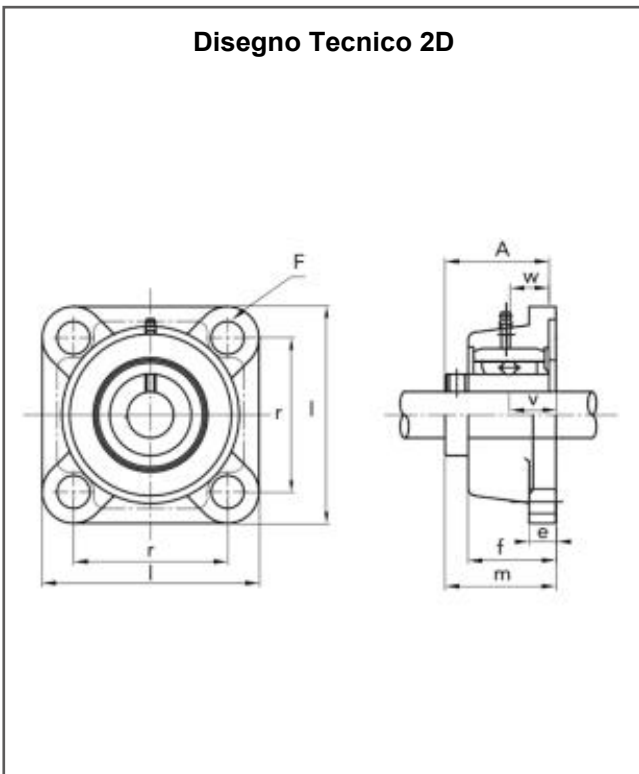
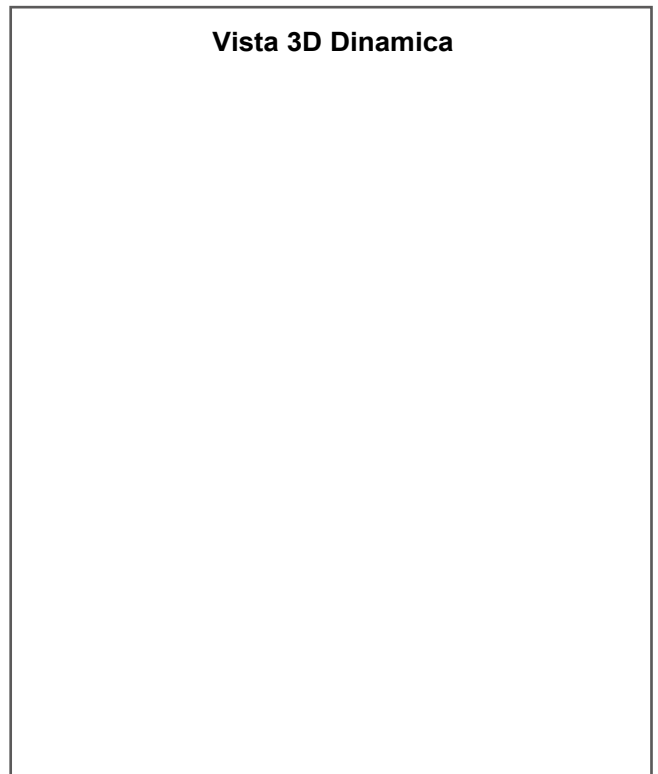

93200208

UCF 200 - Supporti in ghisa

Disegno Tecnico 2D

Vista 3D Dinamica

Specifiche Tecniche

Numero di parte (CODE)	93200208
UCF (UCF)	208
Ø Foro albero (D) mm	40
I (L) mm	130
r (R) mm	102
v (V) mm	21
e (E) mm	15
f (FM) mm	36.0
F (F) mm	16
m (M) mm	51.2
A (A) mm	49.2
w (W) mm	19.0
Cuscinetto n. (BEARING)	UC 208
MB (MB) mm	14
Alloggiamento n. (HOUSING)	P208