

TIMEGUARD®

9W LED Energy Saver
Bulkhead Light

Model: LEDBH09W - Silver



Installation & Operating Instructions

1. General Information

These instructions should be read carefully and retained for further reference and maintenance.

2. Safety

- Before installation or maintenance, ensure the mains supply to the luminaire is switched off and the circuit supply fuses are removed or the circuit breaker turned off.
- It is recommended that a qualified electrician is consulted or used for the installation of this luminaire and install in accordance with the current IEE wiring and Building Regulations.
- Check that the total load on the circuit including when this luminaire is fitted does not exceed the rating of the circuit cable, fuse or circuit breaker.

3. Technical Specifications

- 230V AC 50 Hz
- This luminaire is of class I construction and must be earthed
- 9W LED non replaceable lamp
- Energy Efficiency: Class A
- Energy Usage: 9.3KwH/1000H
- Lumen Output: 530lm
- Colour Temperature: 5000K
- IP65 Rated suitable for restricted external applications
- CE Approved
- Dimensions: 155mm x 100mm x 52mm
- Mounting Hole Centres: 124mm

4. Installation

- Remove the front of the unit by undoing the 4 Allen bolts (a 2.5mm Allen key is required), remove the bezel and lens with gasket.
- Mark the position of the mounting holes on the wall using the unit as a template.
- Drill the holes for the wall plugs ensuring not to infringe with any gas/water pipes or electrical cables that may be hidden below the surface.
- Undo the cable gland sufficiently to allow the cable to be pushed through the back.
- Secure the supply cable into the luminaire through the hole(s) provided ensuring that a cable gland, grommet or sealing compound is used to maintain the IP rating of the luminaire.
- Leave enough slack to allow for wiring, re-tighten the cable gland.
- Fix the luminaire using the correct screws for the wall plugs installed.
- Terminate the cable into the terminal block (see section 5 connection diagram) ensuring correct polarity is observed and that all bare conductors are sleeved.
- Secure the supply cable using the cable clamp.
- Reposition the lens over the unit, taking care to ensure the gasket is in place.
- Secure the lens and bezel back into place using the 4 Allen bolts previously removed at the beginning of the installation. Note: 4x Pozi screws are supplied, which can be used instead of the 4x Allen bolts.

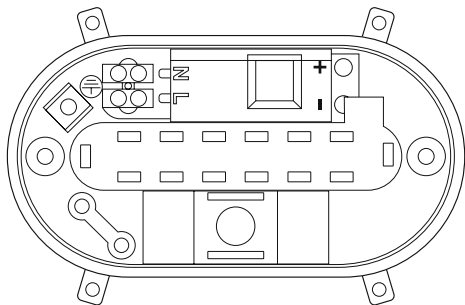

5. Connection

MAINS SUPPLY

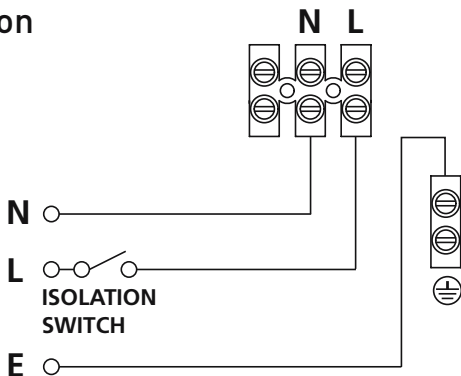

Live (brown or red)

L

Neutral (blue or black)

N

Earth (green/yellow)



3

6. Operation

Turn the power and the unit will illuminate.

3 Year Guarantee

In the unlikely event of this product becoming faulty due to defective material or manufacture within 3 years of the date of purchase, please return it to your supplier in the first year with proof of purchase and it will be replaced free of charge.

For years 2 and 3 or any difficulty in the first year, telephone the helpline on 020 8450 0515.

Note: A proof of purchase is required in all cases. For all eligible replacements (where agreed by Timeguard) the customer is responsible for all shipping/postage charges outside of the UK. All shipping costs are to be paid in advance before a replacement is sent.



If you experience problems, do not immediately return the unit to the store. Telephone the Timeguard Customer Helpline;

HELPLINE

020 8450 0515

or email helpline@timeguard.com

Qualified Customer Support Co-ordinators will be on-line to assist in resolving your query.



A **theben** Group Company

For a product brochure please contact:

Timeguard Limited.

Victory Park, 400 Edgware Road,
London NW2 6ND

Sales Office: 020 8452 1112
or email csc@timeguard.com

www.timeguard.com