

IEC Appliance Inlet C14 with Filter, "Lock and Shield" Mounting

Standard- or Medical-Filter



GRF4: with shield and line filter



Description

- Panel Mount:
Snap-in version from rear-side
- 3 Functions:
Appliance Inlet Protection class I, with EMC-shield, Line filter in standard and medical version

Approvals

- VDE Certificate Number: 102348
- UL File Number: E72928
- CSA File Number: 701867

Characteristics

- Time saving "Lock and Shield" snap-in design for rear-panel mounting
- All single elements are already wired
- Innovative EMC-shielding with flexible steel segments for an excellent contact to the panel
- Suitable for use in equipment according to IEC/UL 60950
- Suitable for use in medical equipment according to IEC/UL 60601-1

Other versions on request

- Panel thickness 1.2 mm and 2.0 mm

References

- Alternative: version without line filter [GRF2](#)
- Alternative: Standard version

Weblinks

[pdf-datasheet](#), [html-datasheet](#), [General Product Information](#), [RoHS](#), [CHINA-RoHS](#), [REACH](#), [Mating Connectors](#), [e-Shop](#), [SCHURTER-Stock-Check](#), [Distributor-Stock-Check](#), [Accessories](#)

Technical Data

Ratings IEC	0.5 - 10A @ Ta 40 °C / 250VAC; 50Hz	Appliance-Inlet/-Outlet	C14 acc. to IEC 60320,
Ratings UL/CSA	0.5 - 15A @ Ta 40 °C / 125VAC; 60Hz	Line Filter	UL 498, CSA C22.2 no. 42 (for cold conditions) pin-temperature 70 °C, 10A, Protection Class I
Leakage Current	standard < 0.5mA (250V / 60Hz) medical < 5 µA (250 V / 60 Hz)	MTBF	> 3'300'000h acc. to MIL-HB-217 F
Dielectric Strength	> 1.7kVDC between L-N > 2.7kVDC between L/N-PE Test voltage (2sec)		
Allowable Operation Temp.	-25°C to 85°C		
Climatic Category	25/085/21 acc. to IEC 60068-1		
Degree of Protection	from front side IP 40 acc. to IEC 60529		
Protection Class	Suitable for appliances with protection class I acc. to IEC 61140		
Terminal	Quick connect terminals 4.8 x 0.8 mm		
Panel Thickness s	Screw Mounting screw torque max 0.5Nm Snap-in: 1.5 mm (other on request)		
Material: Housing	Thermoplastic, black, UL 94V-0		

Dimension

GRF4

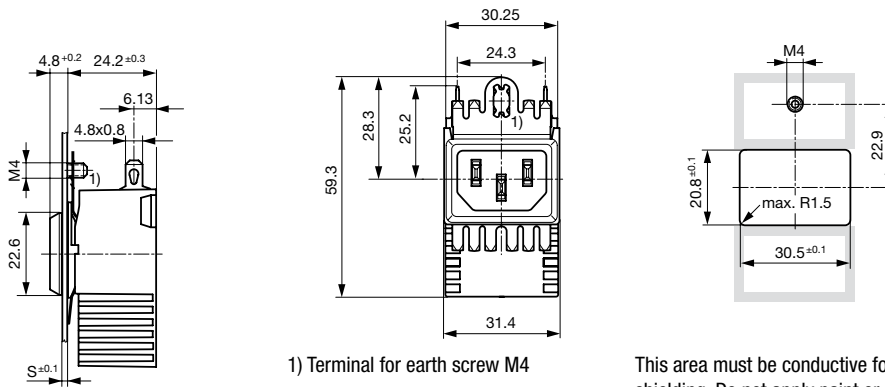

1) Terminal for earth screw M4

This area must be conductive for optimal shielding. Do not apply paint or coatings.

Assembly Instructions

Step 1

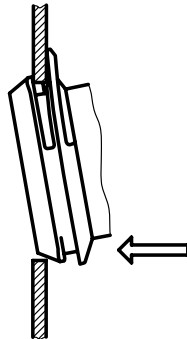

Place the socket in top edge of the panel cut-out.

Step 3

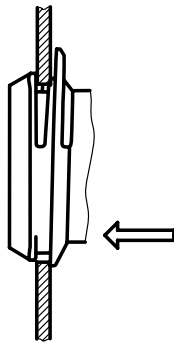

Push the socket forward into the panel cut-out.

Step 2

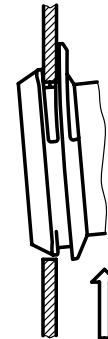

Push the socket upwards.

Step 4

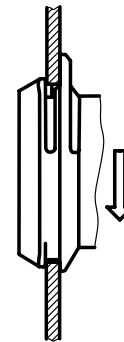

Release the socket. The component is self adjusting.

Technical Data of Filter-Components

Rated Current [A]	Filter-Type	Inductances L [mH]	Capacitance CX [nF]	Capacitance CY [nF]	R [MΩ]
0.5	Standard Version	2 x 24	100	2.2	-
1	Standard Version	2 x 12	100	2.2	-
3	Standard Version	2 x 2.5	100	2.2	-
6	Standard Version	2 x 0.78	100	2.2	-
10	Standard Version	2 x 0.225	100	2.2	-
15	Standard Version	2 x 0.1	100	2.2	-
0.5	Medical Version (M5)	2 x 24	100	-	1
1	Medical Version (M5)	2 x 12	100	-	1
3	Medical Version (M5)	2 x 2.5	100	-	1
6	Medical Version (M5)	2 x 0.78	100	-	1
10	Medical Version (M5)	2 x 0.225	100	-	1
15	Medical Version (M5)	2 x 0.1	100	-	1

Diagrams

Standard version

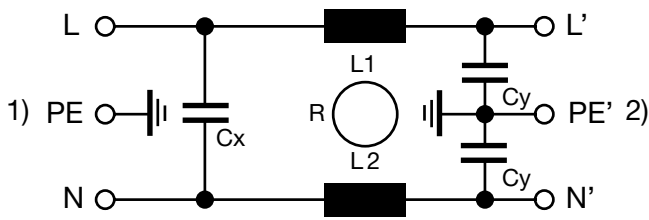

1) Line
2) Load

Medical version

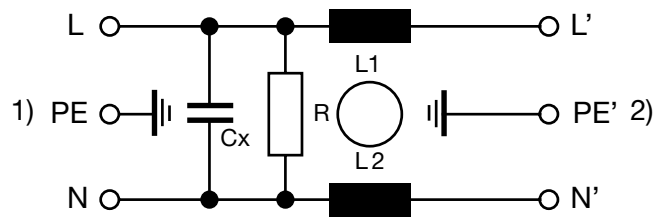

1) Line
2) Load

Attenuation Loss

---- differential mode ____ common mode

Standard version

0.5 A

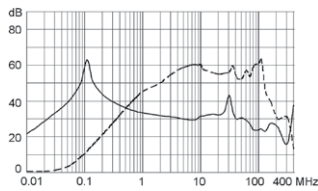

1 A

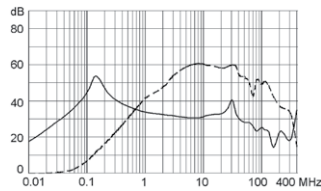

3 A

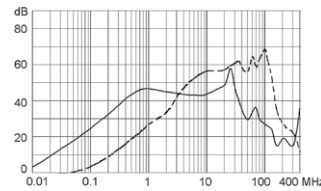

6 A

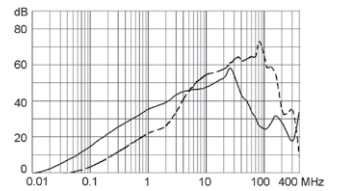

10 A

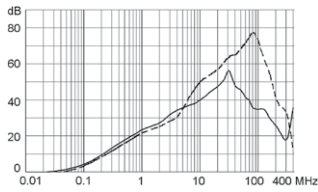

15 A

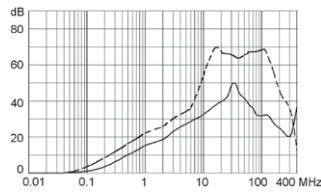

Medical version (M5)

0.5 A

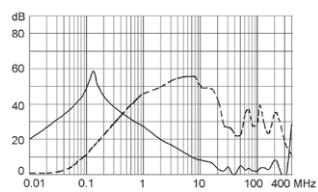

1 A

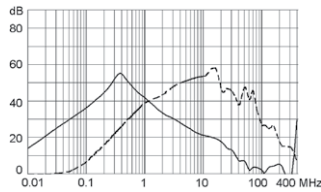

3 A

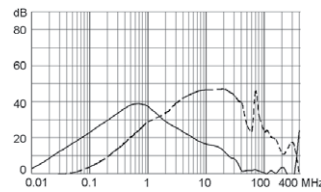

6 A

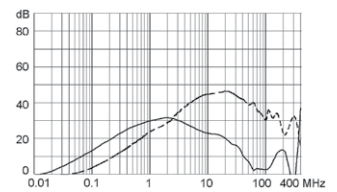

10 A

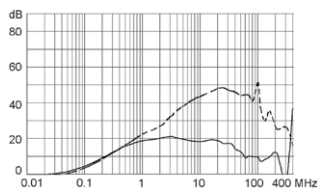

15 A

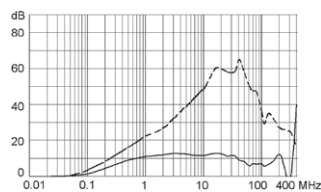

All Variants

Rated Current IEC [A]	Rated Current UL [A]	Filter-Type	Panel Thickness [mm]	Order Number
0.5	0.5	Standard Version	1	GRF4.0411.011.C
1	1	Standard Version	1	GRF4.0412.011.C
6	6	Standard Version	1	GRF4.0416.011.C
10	10	Standard Version	1	GRF4.0417.011.C
0.5	0.5	Standard Version	1.5	GRF4.0411.013.C
1	1	Standard Version	1.5	GRF4.0412.013.C
3	3	Standard Version	1.5	GRF4.0413.013.C
6	6	Standard Version	1.5	GRF4.0416.013.C
10	10	Standard Version	1.5	GRF4.0417.013.C
15	15	Standard Version	1.5	GRF4.0419.013.C
3	3	Standard Version	2	GRF4.0413.014.C
0.5	0.5	Medical Version (M5)	1.5	GRF4.0021.013.C
1	1	Medical Version (M5)	1.5	GRF4.0022.013.C
3	3	Medical Version (M5)	1.5	GRF4.0023.013.C
6	6	Medical Version (M5)	1.5	GRF4.0026.013.C
10	10	Medical Version (M5)	1.5	GRF4.0027.013.C
15	15	Medical Version (M5)	1.5	GRF4.0029.013.C

Most Popular.

Availability for all products can be searched real-time: <http://www.schurter.com/en/Stock-Check/Stock-Check-SCHURTER>

Articles with packing unit 200 (without ending ".C") are no longer available

Packaging unit 20 Pcs

Mating Outlets/Connectors

Category / Description



Appliance Outlet Overview complete

IEC Appliance Outlet F, Screw-on Mounting, Front Side, Solder Terminal	4787
IEC Appliance Outlet F, Snap-in Mounting, Front Side, Solder or Quick-connect Terminal	4788
IEC Appliance Outlet F or H, Screw-on Mounting, Front Side, Solder, PCB or Quick-connect Terminal	5091

[Appliance Outlet further types to GRF4](#)

Connector Overview complete



IEC Connector C13, Rewireable, Straight	4782
IEC Connector C13, Rewireable, Straight	4022
IEC Connector C13, Rewireable, Angled	4785
IEC Connector C13, Rewireable, Angled	4300-06
IEC Connector C13, Rewireable, Angled	4012

[Connector further types to GRF4](#)

...