

# JUMO DELOS SI

## Electronic Pressure Switch with Display



**B 40.5052.0**  
Operating Manual





# Contents

---

<b>1</b>	<b>Typographical conventions .....</b>	<b>5</b>
1.1	Warning signs .....	5
1.2	Note signs .....	5
<b>2</b>	<b>Description .....</b>	<b>6</b>
2.1	General .....	6
<b>3</b>	<b>Identifying the instrument version .....</b>	<b>7</b>
3.1	Nameplate .....	7
3.2	Block diagram .....	7
3.3	Type description .....	8
3.4	Accessories .....	10
<b>4</b>	<b>Electrical connection .....</b>	<b>11</b>
4.1	Installation instructions .....	11
4.2	Color assignment of M12 x 1 round plug .....	11
4.3	Terminal assignment for output 470 .....	12
4.4	Terminal assignment for output 471 .....	12
4.5	Terminal assignment for outputs 475, 476, and 477 .....	13
<b>5</b>	<b>Mounting .....</b>	<b>14</b>
5.1	General information .....	14
5.2	Dimensions of electronic pressure switches .....	16
5.3	Dimensions of process connections, not front-flush .....	17
5.4	Dimensions of process connections, front-flush .....	18
<b>6</b>	<b>Operation .....</b>	<b>21</b>
6.1	Controls .....	21
6.2	LC display .....	21
6.3	Levels .....	22
6.4	Parameter .....	23

---

# Contents

---

<b>7</b>	<b>Commissioning</b> .....	<b>26</b>
7.1	Getting started .....	26
7.2	Unlocking the instrument (code entry) .....	27
7.3	Cancel operation .....	28
7.4	Selecting the unit of the measured value (Uni.P) .....	28
7.5	Setting the zero point (offset) (Off.P) .....	31
7.6	Setting the filter time constant (damping) (DamP) .....	32
7.7	Setting the output signal (S.TyP) .....	32
7.8	Setting scaling .....	33
7.9	Setting the error signal (S.Err) .....	36
7.10	Setting the switching function (B.Fct) .....	37
7.11	Setting the switching point (B.SP) .....	39
7.12	Setting the reset point (B.RSP) .....	40
7.13	Setting the switching difference (hysteresis) (B.HYS) .....	40
7.14	Setting the switching delay (B.DLY) .....	41
7.15	Setting the display alignment (D.Dir) .....	41
7.16	Setting the display unit (D.Uni) .....	42
7.17	Displaying the version of the operating device software (SW.Di) .....	43
7.18	Displaying the version of the signal stage software (SW.Si) .....	43
<b>8</b>	<b>Calibration</b> .....	<b>44</b>
8.1	Setting the zero point (offset) .....	44
<b>9</b>	<b>Setup program</b> .....	<b>45</b>
9.1	Function .....	45
9.2	Start the setup program .....	46
<b>10</b>	<b>Eliminating errors and faults</b> .....	<b>48</b>
10.1	Possible errors .....	48
<b>11</b>	<b>Instrument description</b> .....	<b>49</b>
11.1	<b>Technical data</b> .....	<b>49</b>

---

# 1 Typographical conventions

---

## 1.1 Warning signs



---

### Danger

This symbol is used when there may be **danger to personnel** if the instructions are ignored or not followed correctly!

---



---

### Caution

This symbol is used when there may be **damage to equipment or data** if the instructions are ignored or not followed correctly!

---



---

### Caution

This symbol is used where special care is required when handling components liable to damage through electrostatic discharge.

---

## 1.2 Note signs



---

### Note

This symbol is used to draw your **special attention** to a remark.

---

abc<sup>1</sup>

---

### Footnote

Footnotes are remarks that **refer to specific points** in the text. Footnotes consist of two parts:

Marking in the text and the footnote text.

The markers in the text are arranged as sequential superscript numbers.

---

\*

---

### Action instruction

This symbol indicates that an **action to be performed** is described.

The individual steps are marked by this asterisk.

Example:

\* Loosen Phillips-head screws.

---

## 2 Description

---

### 2.1 General

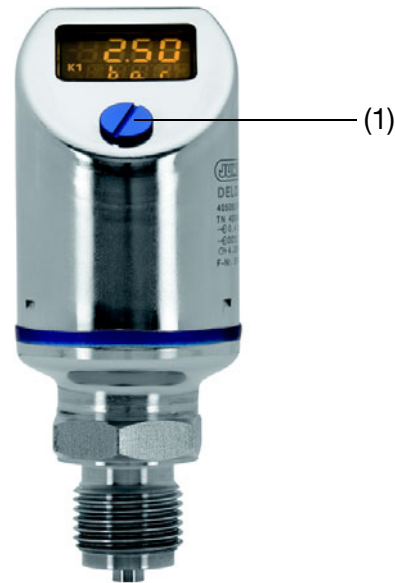

- Depending on its design, the instrument measures relative or absolute pressure in liquid and gaseous media.
- The pressure is displayed digitally.
- Depending on the design, the following outputs are available:
  - 1 PNP switching output
  - 2 PNP switching outputs
  - 1 PNP switching output + 1 analog output 4 ... 20 mA <sup>1</sup>
  - 1 PNP switching output + 1 analog output 0 ... 20 mA <sup>1</sup>
  - 1 PNP switching output + 1 analog output 0 ... 10 V <sup>1</sup>
- The instrument is also available in a design for use at elevated medium temperatures.
- The instrument can be adjusted directly on site or can be configured via PC with a setup program.



The protection type specified for the device (See section 11.1 "Technical data", page 49) can only be achieved with the control opening (1) closed.

---

<sup>1</sup> The output is freely configurable.

---

# 3 Identifying the instrument version

## 3.1 Nameplate

on the  
pressure switch

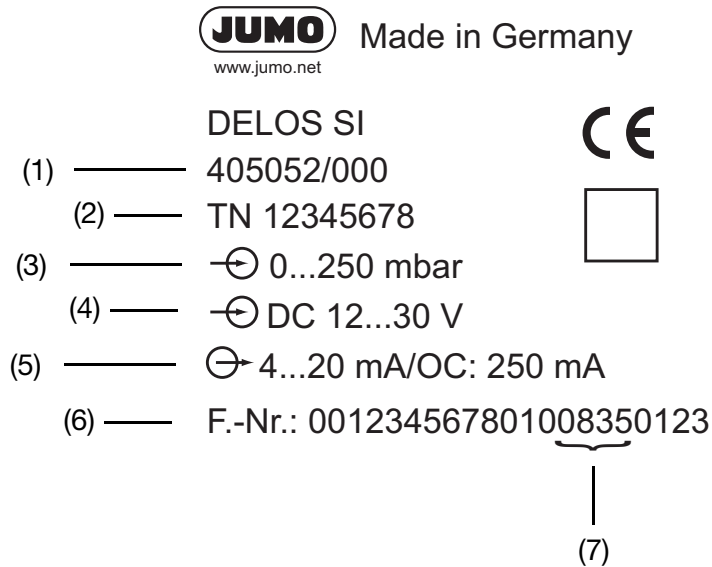

- |                          |                                                     |
|--------------------------|-----------------------------------------------------|
| (1) Type                 | (5) Output signal                                   |
| (2) Part number          | (6) Manufacturing number                            |
| (3) Measuring range      | (7) Date of manufacture<br>(year and calendar week) |
| (4) Power supply voltage |                                                     |

## 3.2 Block diagram

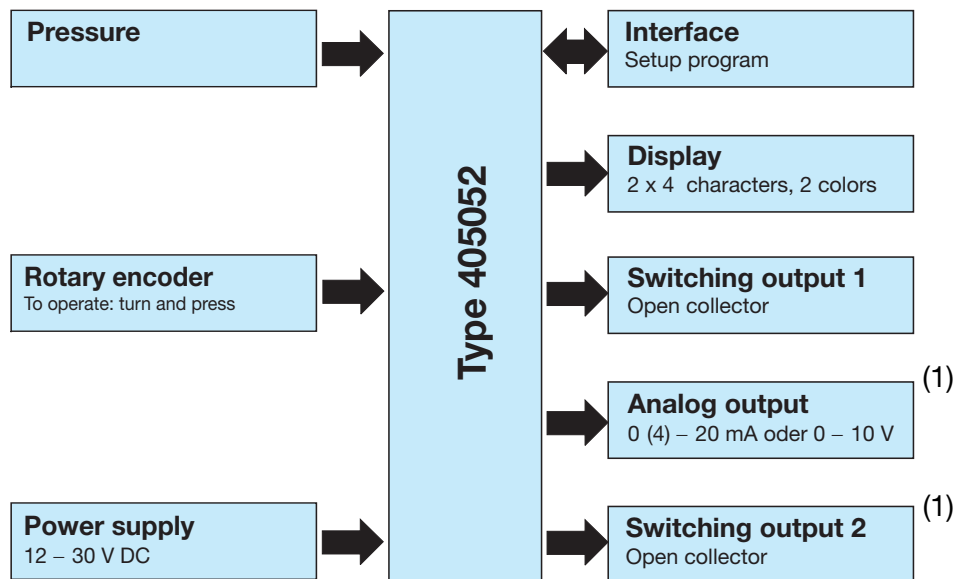

<sup>1</sup> optional

## 3 Identifying the instrument version

---

### 3.3 Type description

	<b>(1) Basic type</b>
405052	JUMO DELOS SI Electronic Pressure Switch with Display
	<b>(2) Basic type extension</b>
000	None
004	For elevated medium temperatures up to 200°C <sup>1</sup>
999	Special design
	<b>(3) Nominal (rated) measuring range</b>
	<b>Measuring range - pressure</b>
452	0 ... 400 mbar relative pressure
454	0 ... 1 bar relative pressure
457	0 ... 4 bar relative pressure
459	0 ... 10 bar relative pressure
461	0 ... 25 bar relative pressure
463	0 ... 60 bar relative pressure
	<b>Measuring range - vacuum</b>
447	-400 ... 400 mbar relative pressure
449	-1 ... 1 bar relative pressure
481	-1 ... 3 bar relative pressure
483	-1 ... 9 bar relative pressure
485	-1 ... 24 bar relative pressure
	<b>Measuring range absolute pressure</b>
486	0 ... 400 mbar absolute pressure
488	0 ... 1 bar absolute pressure
491	0 ... 4 bar absolute pressure
493	0 ... 10 bar absolute pressure
495	0 ... 25 bar absolute pressure
506	0 ... 60 bar absolute pressure
	<b>(4) Output</b>
470	1 x PNP switching output
471	2 x PNP switching output
475	1 x PNP switching output + analog output 4 ... 20 mA, three wires <sup>2</sup>
476	1 x PNP switching output + analog output 0 ... 20 mA, three wires <sup>2</sup>
477	1 x PNP switching output + analog output 0 ... 10 V, three wires <sup>2</sup>

---

<sup>1</sup> Front-flush only for process connection.

<sup>2</sup> Factory setting - the output is freely configurable.

---



### 3 Identifying the instrument version

**(5) Process connection**

**Not front-flush**

- 504 G 1/2
- 511 1/4-18 NPT
- 521 G 1/4 to DIN 3852 T11
- 523 G 1/2 to DIN 3852 T11
- 998 Suitable for connecting to pressure measuring instrument

**Front-flush**

- 571 G 3/4
- 575 G 3/4 seal positioned in front
- 576 G1 seal positioned in front
- 603 Tapered adapter with groove nut, to DIN11 851, DN20<sup>4</sup>
- 604 Tapered adapter with groove nut, to DIN11 851, DN25<sup>4</sup>
- 606 Tapered adapter with groove nut, to DIN11 851, DN40<sup>4</sup>
- 607 Tapered adapter with groove nut, to DIN11 851, DN50<sup>4</sup>
- 612 Clamp to DIN 32 676, DN20<sup>4</sup>
- 613 Clamp to DIN 32 676, DN25<sup>4</sup>
- 616 Clamp to DIN 32 676, DN50<sup>4</sup>
- 623 Small flange connection<sup>4</sup>
- 652 Tank connection with groove union nut<sup>4</sup>, DN25
- 997 JUMO PEKA (EHEDG-certified)<sup>3</sup>
- 998 Suitable for connecting to pressure measuring instrument

**(6) Process connection material**

- 20 Stainless steel 316L

**(7) Electrical connection**

- 36 Round plug M 12 x 1

**(8) Measuring system filling medium**

- 01 FDA-compliant oil
- 99 Special filling medium

**(9) Extra codes**

- 000 None
- 591 Throttle in pressure channel
- 624 Free of oil and grease
- 691 Cast version

<b>Order code</b>	(1)		/	(2)		-	(3)		-	(4)		-	(5)		-	(6)		-	(7)		-	(8)		/	(9)			
<b>Sample order</b>		405052			/		000		-	459		-	471		-	504		-	20		-	36		-	1		/	000

<sup>3</sup> For matching process connection adapter see data sheet 40.9711

<sup>4</sup> For measuring ranges up to 25 bar only

## 3 Identifying the instrument version

---

### 3.4 Accessories

Sales No.	Designation
40/00404585	4-pin cable connector (straight) M 12 x 1 with 2-m PVC cable
40/00409334	4-pin angle box M 12 x1 with 2-m PVC cable
40/00522384	Setup program
40/00507861	Connecting cable (only required for programming with the setup program)
70/00456352	PC interface line including USB/TTL converter and adapter (USB connecting cable) <sup>1</sup>

---

---

<sup>1</sup> Please order a connecting cable as well.

---

### 4.1 Installation instructions



The electrical connection must only be performed by qualified personnel!

- The load circuits must be fused for the maximum load currents in each case to prevent the instrument from being destroyed.
  - Electromagnetic compatibility meets the requirements of EN 61326,
  - No other consumers can be connected to the power supply of the instrument.
  - The instrument is not suitable for installation in areas with an explosion hazard.
  - Apart from faulty installation, incorrect settings on the instrument may also affect the proper functioning of the subsequent process or lead to damage. You should therefore always provide safety equipment that is independent of the instrument and it should only be possible for qualified personnel to make settings.
- 

### 4.2 Color assignment of M12 x 1 round plug



The following color assignment applies only to A-coded standard cables!

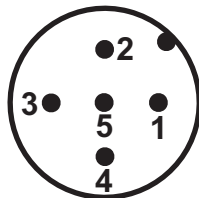

- |   |       |
|---|-------|
| 1 | Brown |
| 2 | White |
| 3 | Blue  |
| 4 | Black |
| 5 | Gray  |
-

## 4 Electrical connection

### 4.3 Terminal assignment for output 470

One PNP switching output	
Power supply voltage	
1 L+	12 ... 30 V DC
3 L-	GND
Output	
4 K1	Highside Open Collector maximum 0.25 A
2	nc
5	Interface

### 4.4 Terminal assignment for output 471

Two PNP switching outputs	
Power supply voltage	
1 L+	12 ... 30 V DC
3 L-	GND
Output	
4 K1	Highside Open Collector maximum 0.25 A
2 K2	
5	Interface

## 4 Electrical connection

### 4.5 Terminal assignment for outputs 475, 476, and 477

One PNP switching output + one analog output	
Power supply voltage	
1 L+	12 ... 30 V DC
3 L-	GND
Output	
4 K1	Highside Open Collector maximum 0.25 A
2 Analog	0(4)...20 mA / 0...10 V
5	Interface

# 5 Mounting

---

## 5.1 General information

---



The compatibility of the instrument with the measuring medium must be tested,  
See section 11.1 "Technical data", page 49.

---

### Mounting location

- Find a location that ensures easy accessibility for later operation.
  - The fastening must be secure and must ensure low vibration for the instrument.
  - Avoid direct sunlight!
  - Permissible ambient temperature at the installation location See section 11.1 "Technical data", page 49.
- 

### Installation position

The instrument can be mounted in any position.  
The "vertical" installation position is recommended, see illustration.



### 5.1.1 Rotating the display

The display image can be rotated 180° in the software, See section "Display position", page 25. This may make it easier to read when the instrument is installed overhead, for example.



### 5.1.2 Rotating the housing

The instrument housing can be rotated a maximum of 320° with the combination tool (1).

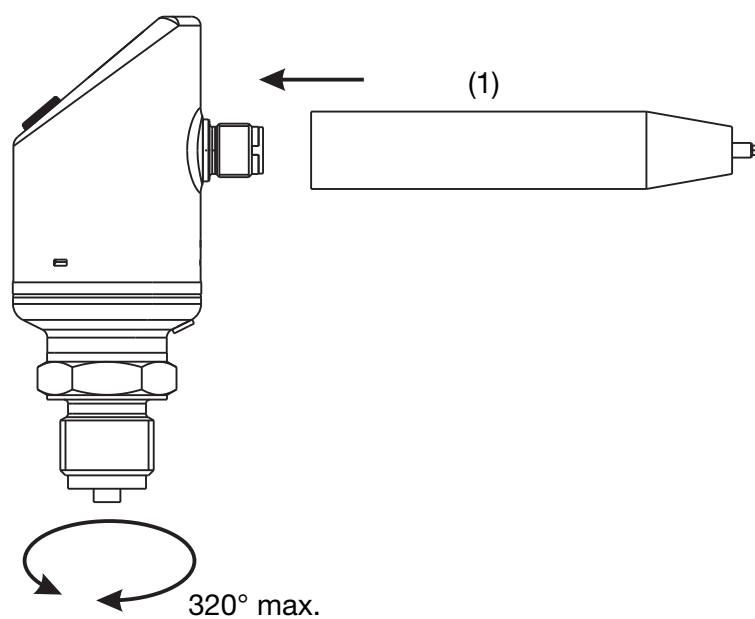

## 5 Mounting

---

### 5.2 Dimensions of electronic pressure switches

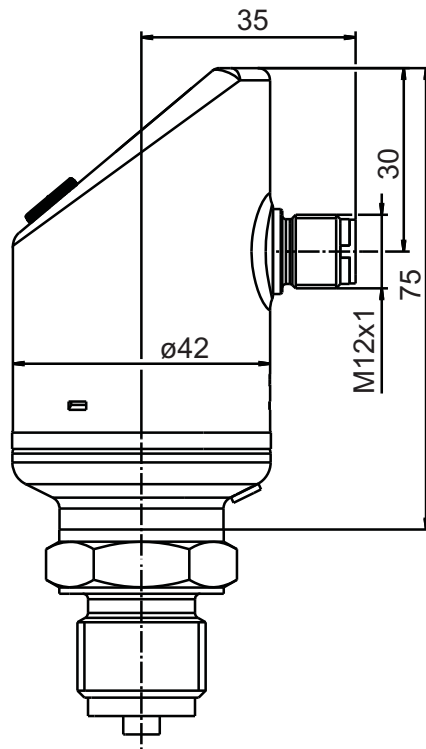

Type 405052/000-...

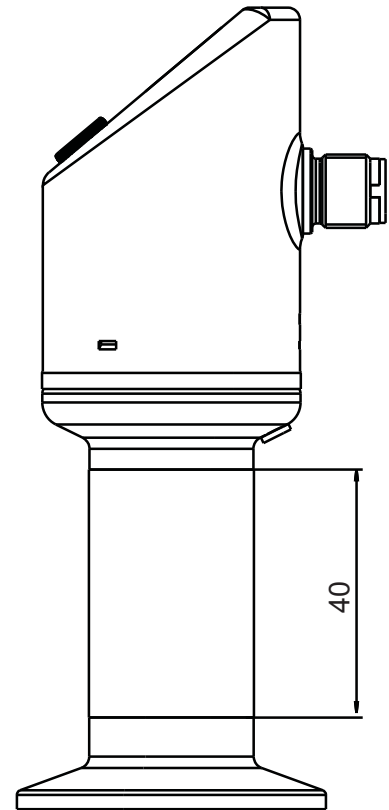

Type 405052/004-...



The overall height is 40 mm greater for instruments with basic type extension 004 (for increased medium temperature up to 200°C). See drawing



## 5.3 Dimensions of process connections, not front-flush

504

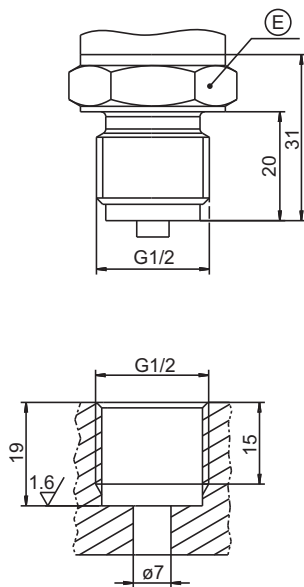

511

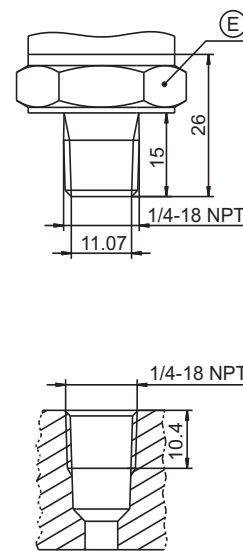

521

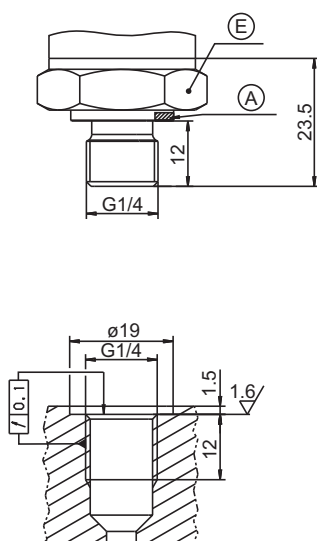

523

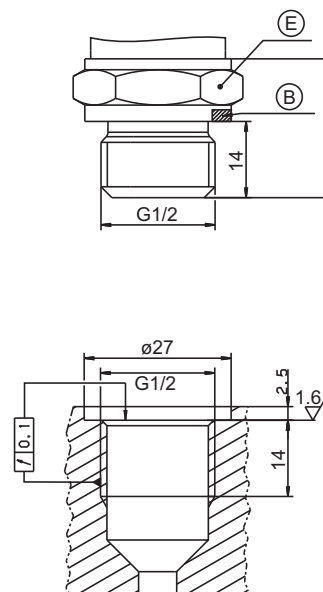

A = Profile seal DN G3/4

B = Profile seal DN G1/2

E = SW 27

F = SW 32

# 5 Mounting

## 5.4 Dimensions of process connections, front-flush

571

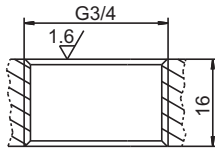
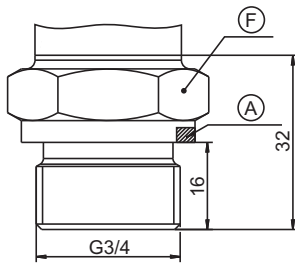

575

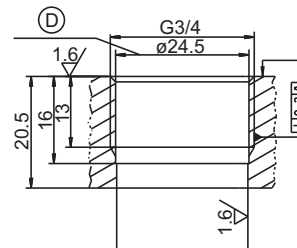
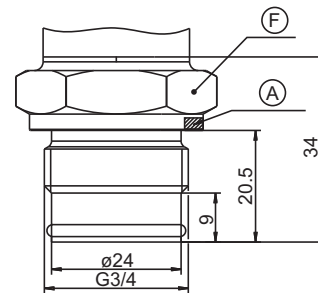

576

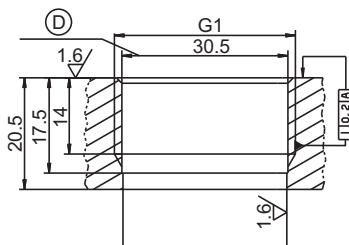
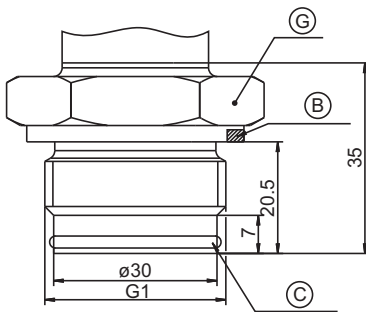

A = profile seal DN G3/4  
 B = profile seal DN G1  
 C = O-ring 26.7 x 1.78

D = Drill out after tapping  
 F = SW 32  
 G = SW 41

## 5 Mounting

603 to 607

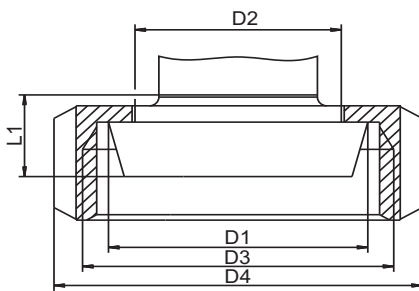

Process connection	DN	ø D1	ø D2	ø D3	ø D4	L1
603	20	36.5	30	RD 44 x 1/6	54	13
604	25	44	35	RD 52 x 1/6	63	15
606	40	56	48	RD 65 x 1/6	78	
607	50	68.5	61	RD 78 x 1/6	92	16

612 to 616

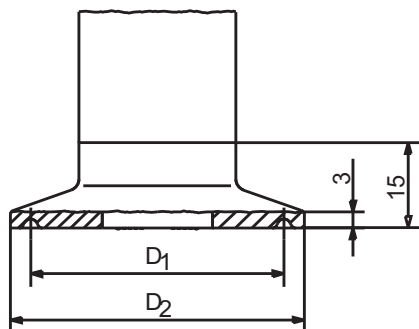

Process connection	DN DIN 32676	DN (inches)	Nominal Size ISO 2852	ø D1	ø D2
612	20 15		12	27.5	34
			12.7		
			17.2		
			21.3		
613	25 32 40	1" 1.5"	25	43.5	50.5
			33.7		
			38		
616	50	2"	40	56.5	64
			51		

# 5 Mounting

---

623

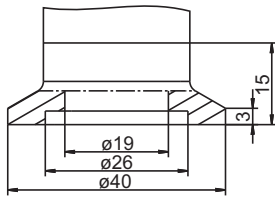

652

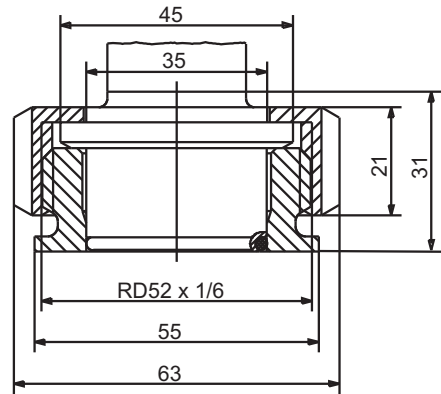

997

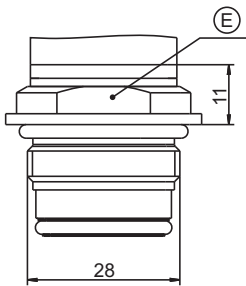

E = SW 27



Process connection 997 is EHEDG-certified  
For detailed information about this process connection system, see  
data sheet 40.9711.

### 6.1 Controls

---

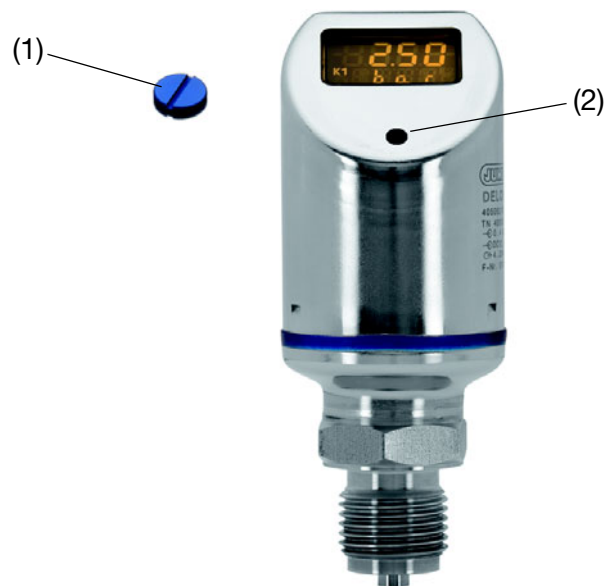

(1) Protective screw

(2) Hexagon socket

- 
- \* Unscrew the protective screw (1).
  - \* "Turn / push" the control element (2) with the enclosed combination tool (or a 0.5x3 screwdriver).
- 

### 6.2 LC display

#### 6.2.1 Measurement mode (normal display)

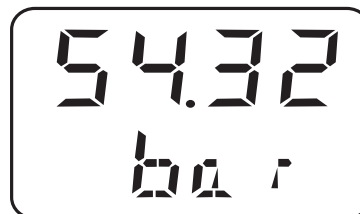

Example:  
The display is lit yellow.

# 6 Operation

## 6.2.2 Settingmode



Example:  
The display is lit red.

### Operation

Continue	Press the combination tool less than 1 second (< 1 s)
Yes (accept)	Press the combination tool less than 1 second (< 1 s)
No (Cancel)	Press the combination tool more than 3 seconds (> 3 s)
Timeout	No activity for more than 60 seconds (>60 s)



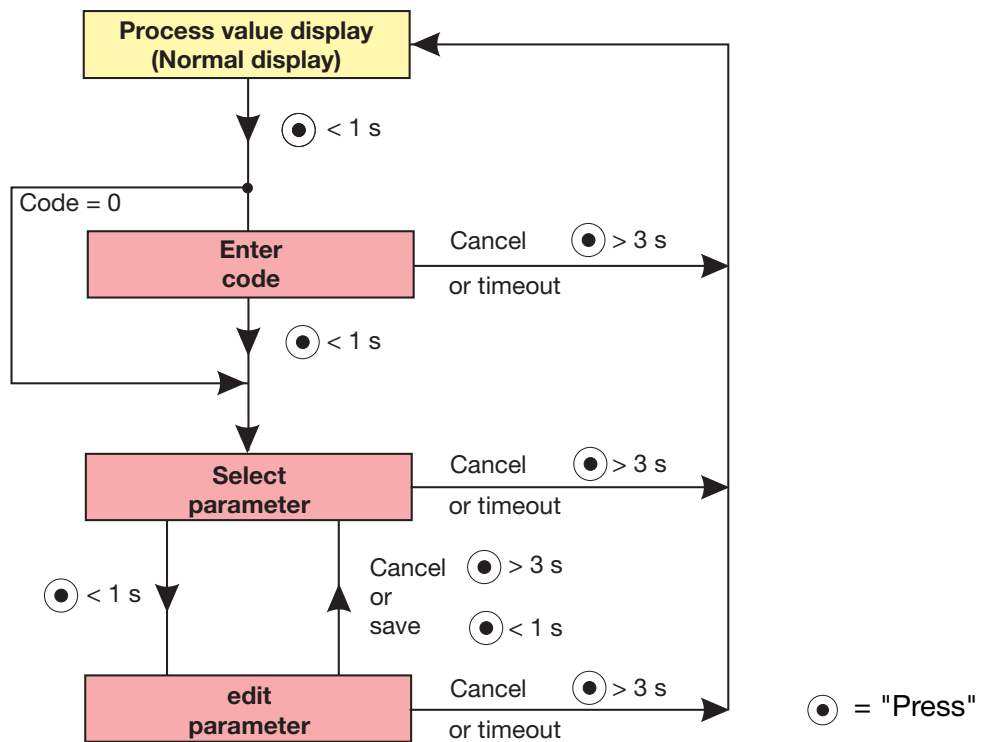

To return to measuring mode:  
 - "No (Cancel)" or  
 - Wait for timeout = no activity performed for 60 seconds.

## 6.3 Levels



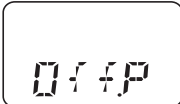

### 6.4 Parameter

#### 6.4.1 Input

Parameter	Display	Setting range <sup>1</sup>
Pressure unit		bar kPa MPa psi mbar <b>Note:</b> The units kPa and mbar cannot be configured for all measuring ranges.
Offset (zero-point correction)		-20.00 ... <b>0.00</b> ... +20.00% of the measuring range <b>Note:</b> Automatic offset correction See section 7.5 "Setting the zero point (offset) (Off.P)", page 31.
Damping (filter time constant)		<b>0.00</b> ... 99.99 s

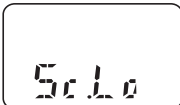
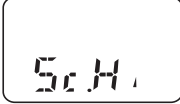
#### 6.4.2 Analog output

Parameter	Display	Setting range <sup>1</sup>
Signal type (for analog output)		<b>4 ... 20 mA</b> 0 ... 20 mA 0 ... 10 V
Scaling start (for analog output)		<b>0.00</b> ... 75.00% of nominal measuring range
Scaling end (for analog output)		25.00 ... <b>100%</b> of nominal measuring range
Signal for error (for analog output)		3.4 mA or 22 mA for output signal 4...20 mA 0 mA or 22 mA for output signal 0...20 mA 0 V or 10.7 V for output signal 0...10 V <b>Note:</b> Depending on the configured output signal.

<sup>1</sup> The default setting is marked in **bold**.

## 6 Operation

### 6.4.3 Binary output 1

Parameter	Display	Setting range <sup>1</sup>
Switching function (for switching output only)		<b>Hysteresis, make contact</b> Hysteresis, break contact Window, make contact Window, break contact  See section 7.10 "Setting the switching function (B.Fct)", page 37.
Switching point (for switching output only)		<b>0.00</b> ... 100.00% of nominal measuring range See section 7.10 "Setting the switching function (B.Fct)", page 37.
Reset point (for switching output only)		<b>0.00</b> ... 100.00% of nominal measuring range See section 7.10 "Setting the switching function (B.Fct)", page 37.
Hysteresis (for switching output and configured switching point or reset point only)		<b>0.00</b> ... 100.00% of nominal measuring range See section 7.10 "Setting the switching function (B.Fct)", page 37.  <b>Note:</b> Used only with window switching functions.
Switching delay (for switching output only)		<b>0.00</b> ... 99.99 s See section 7.10 "Setting the switching function (B.Fct)", page 37.

### 6.4.4 Binary output 2

Parameter	Display	Setting range <sup>1</sup>
Switching function (for second switching output only)		<b>Hysteresis, make contact</b> Hysteresis, break contact Window, make contact Window, break contact  See section 7.10 "Setting the switching function (B.Fct)", page 37.
Switching point (for second switching output only)		<b>0.00</b> ... 100.00% of nominal measuring range See section 7.10 "Setting the switching function (B.Fct)", page 37.
Reset point (for switching output only)		<b>0.00</b> ... 100.00% of nominal measuring range See section 7.10 "Setting the switching function (B.Fct)", page 37.
Hysteresis (for second switching output and configured switching point or reset point only)		<b>0.00</b> ... 100.00% of nominal measuring range See section 7.10 "Setting the switching function (B.Fct)", page 37.  <b>Note:</b> Used only with window switching functions.





<sup>1</sup> The default setting is marked in **bold**.

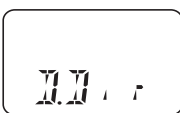

## 6 Operation

Parameter	Display	Setting range <sup>1</sup>
Switching delay (for second switching output only)		<b>0.00</b> ... 99.99 s See section 7.10 "Setting the switching function (B.Fct)", page 37.

### 6.4.5 Display and operation

Parameter	Display	Setting range <sup>1</sup>
Display position		Normal (for normal operation) Rotated (for overhead operation) See section 7.15 "Setting the display alignment (D.Dir)", page 41.
Unit of actual value display (for analog output only)		Pressure unit (see parameter "Uni.P") Percentage of the scaled range See section 7.16 "Setting the display unit (D.Uni)", page 42.
Version D		Software version of the operating device See section 7.17 "Displaying the version of the operating device software (SW.Di)", page 43.
Version S		Software version of the signal stage See section 7.18 "Displaying the version of the signal stage software (SW.Si)", page 43.
Code (can only be edited via setup program)		0000 ... <b>0072</b> .... 9999 See section 7.2 "Unlocking the instrument (code entry)", page 27.

# 7 Commissioning

---

## 7.1 Getting started



This is a suggestion for configuring the instrument reliably in little time.

By checking the setting options of this list before starting the configuration, you can avoid timeouts during the configuration.

---

- \* Mounting the instrument, See section 5 "Mounting", page 14.
  - \* Installing the instrument, See section 4 "Electrical connection", page 11.
  - \* Unlocking the instrument, See section 7.2 "Unlocking the instrument (code entry)", page 27.
  - \* Selecting the unit of the measured value, See section 7.4 "Selecting the unit of the measured value (Uni.P)", page 28.
  - \* Adjusting the output signal, See section 7.7 "Setting the output signal (S.TyP)", page 32.
  - \* Adjusting the scaling of the output signal (restricting the measuring range), See section 7.8 "Setting scaling", page 33.
  - \* Setting the switching function, See section 7.10 "Setting the switching function (B.Fct)", page 37.
  - \* Setting the switching point, See section 7.11 "Setting the switching point (B.SP)", page 39.
-

### 7.2 Unlocking the instrument (code entry)

The instrument is protected by a code to prevent unauthorized operation.

The code is set to 0072 in the factory. It can only be changed with the setup program. If the code is set to 0000 with the setup program, the instrument is unprotected.

#### Unlocking

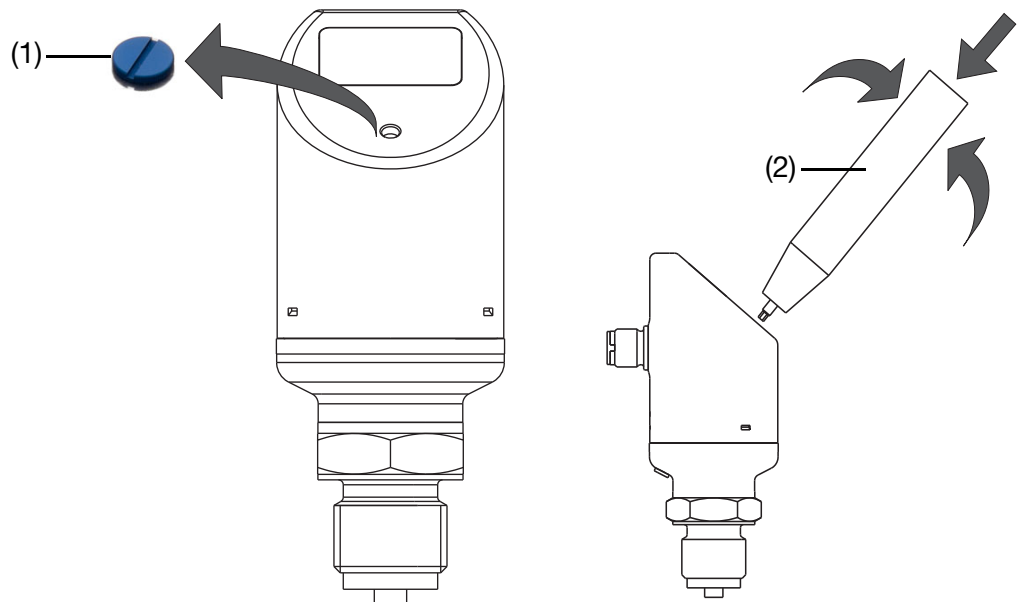

- \* Unscrew the protective screw (1)
- \* Continue briefly pressing the combination tool (2) until the third "0" from the left is flashing.  
The color of the display also changes to "red."
- \* Turn the combination tool until "7" is displayed.
- \* Continue briefly pressing the combination tool until the fourth "0" from the left is flashing.
- \* Turn the combination tool until "2" is displayed.



- \* Press the combination tool briefly - the instrument switches to the

## 7 Commissioning

---

parameter level.



After an incorrect code is entered:

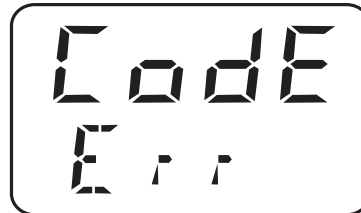

---

### 7.3 Cancel operation

- \* Press and hold the combination tool (2) longer than 3 seconds or
  - \* wait for timeout (no activity for longer than 60 seconds).
- 

### 7.4 Selecting the unit of the measured value (Uni.P)

- \* Unlock the instrument, See section 7.2 "Unlocking the instrument (code entry)", page 27.
- \* "Rotate" until the bottom line shows "Uni.P".
- \* "Press"

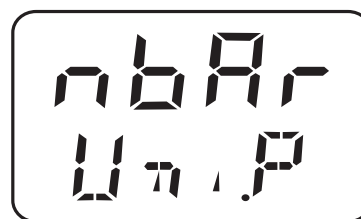

- \* The measured pressure is shown in millibar.
- \* "Press"

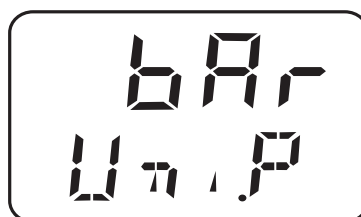

Flashing

Continuous

The measured pressure is shown in bar.

---

## 7 Commissioning

---

\* "Rotate"



The measured pressure is shown in Kilopascal.

\* "Rotate"

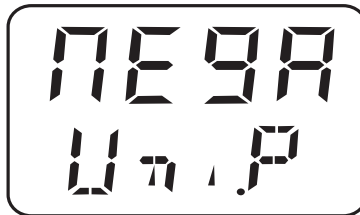

The measured pressure is shown in Megapascal (MPa).

\* "Rotate"



The measured pressure is shown in psi.

To confirm setting: "Press" until the display is no longer flashing.

---

# 7 Commissioning

## 7.4.1 Display and setting options of the instrument

Measuring range	Unit	Display	
		Start	End
-0.4 ... 0.4 bar	mbar	-400.0	400.0
	bar	-0.400	0.400
	kPa	-40.00	40.00
	MPa	-0.040	0.040
	psi	-5.802	5.802
-1 ... 3 bar	mbar	-1000	3000
	bar	-1.000	3.000
	kPa	-100.0	300.0
	MPa	-0.100	0.300
	psi	-14.50	43.51
0 ... 60 bar	mbar	0000	9999
	bar	00.00	60.00
	kPa	0000	6000
	MPa	0.000	6.000
	psi	000.0	870.2
-1 ... 9 bar	mbar	-1000	9000
	bar	-1.000	9.000
	kPa	-100.0	900.0
	MPa	-0.100	0.900
	psi	-14.5	130.5
-1 ... 24 bar	mbar	-1000	9999
	bar	-1.00	24.00
	kPa	-100	2400
	MPa	-0.100	2.400
	psi	-14.5	348.1



Gray cells are units that cannot be configured! Display overflow - values do not appear in operation or in setup!

## 7.5 Setting the zero point (offset) (Off.P)

### 7.5.1 Automatic offset adjustment

This setting is used to accept the current measured value as the new zero point.



Automatic offset adjustment is only possible for instruments with a relative pressure measuring range!

- \* Unlock the instrument, See section 7.2 "Unlocking the instrument (code entry)", page 27.
- \* "Rotate" until the bottom line shows "Off.P".
- \* "Press" twice in quick succession  
The current measured value is accepted as the zero point.

### 7.5.2 Edited offset setting

This setting is used to increase or reduce the measured pressure selectively by an adjustable value.

- \* Unlock the instrument, See section 7.2 "Unlocking the instrument (code entry)", page 27.
- \* "Rotate" until the bottom line shows "Off.P".
- \* "Press"

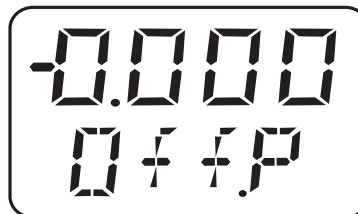

"-" Flashing

Continuous



"-" means: the offset is negative - the measured pressure is reduced.

Enter the value "digit by digit."

## 7 Commissioning

---

### 7.6 Setting the filter time constant (damping) (DamP)

The filter time constant (damping) can be used to smooth the measured value.  
Small filter time constant: the display is refreshed quickly.  
Large filter time constant: Display refresh is slower.

The value is entered in seconds with two places after the decimal.

- \* Unlock the instrument, See section 7.2 "Unlocking the instrument (code entry)", page 27.
- \* "Rotate" until the bottom line shows "Dam.P".
- \* "Press"

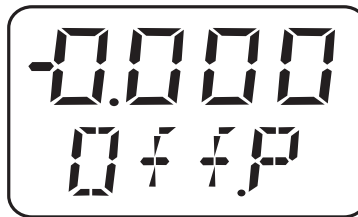

### 7.7 Setting the output signal (S.TyP)

- \* Unlock the instrument, See section 7.2 "Unlocking the instrument (code entry)", page 27.
- \* "Rotate" until the bottom line shows "S.TyP".
- \* "Press"



Example

4.20A = output signal 4 ... 20 mA  
0.20A = output signal 0 ... 20 mA  
0.10U = output signal 0 ... 10 V

---



## 7.8 Setting scaling

**Customer-specific measuring range**

The customer measuring range (2) is defined by:

- Range start (4)
- Range end (5)
- Span (MSP)

**Example**

**Actual**

The instrument has a nominal measuring range (1) from 0 to 4 bar

**Target**

The customer would like to measure the pressure in the range from 1 to 2 bar (25% of the nominal measuring range).

Range start (5) is 1 bar

Range end (6) is 2 bar

Span (MSP) is 1 bar

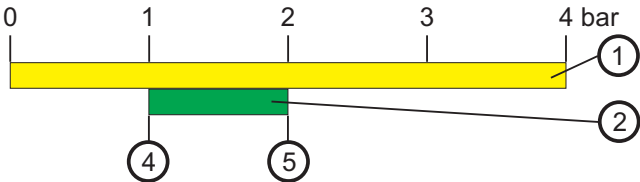

**Scaling**

The scaling of the instrument's output signal describes how the measured pressure is converted into an output signal.

**Simple example**

**Actual**

The instrument has a nominal measuring range (1) from 0 to 4 bar and the instrument has an output signal from 4 to 20 mA (3).

**Target**

The customer would like:  
 the "Customer measuring range" (2) from 0 to 4 bar (100% of nominal measuring range (1))  
 should correspond to the output signal (3) from 4 to 20 mA (100%).

The scaling is 1: 1 (100% to 100%).

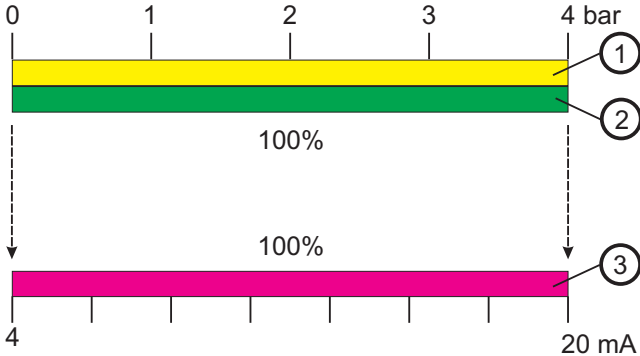

**Customer-specific scaling**

It is often useful to scale part of the nominal measuring range to the output signal.

# 7 Commissioning

## Example

### Actual

The instrument has a nominal measuring range (1) from 0 to 4 bar and the instrument has an output signal from 4 to 20 mA (3).

### Target

The customer would like:

the "Customer measuring range" (2) from 1 to 2 bar (25% of nominal measuring range (1))

should correspond to the output signal from 4 to 20 mA (100%).

The scaling is 1: 4 (25% to 100%).

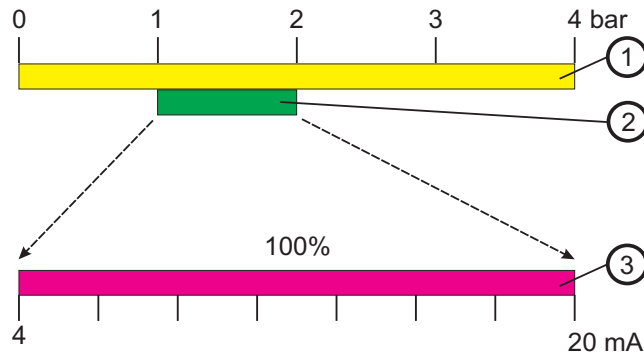

## Inversion of the output signal

The instrument provides the option of inverting the output signal (3).

The output signal

- 0 to 20 mA becomes output signal 20 to 0 mA
- 4 to 20 mA becomes output signal 20 to 4 mA
- 0 to 10 V becomes output signal 10 to 0 V

## Example 20 to 4 mA

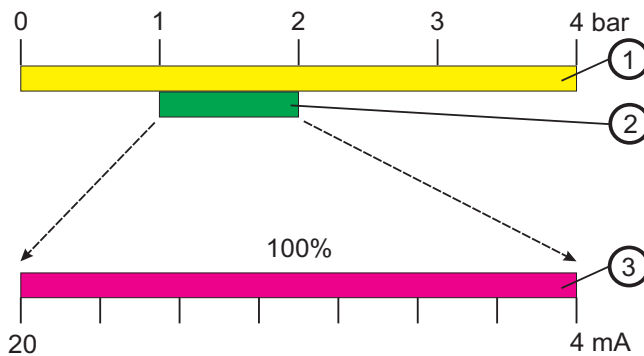

## Abbreviations

(1)	Nominal measuring range (NMB)	(4)	Range start (MA)
(2)	Customer measuring range (MB)	(5)	Range end (ME)
(3)	Output signal		Span (MSP)

## 7 Commissioning

### 7.8.1 Setting the starting value of scaling (Sc.Lo)



The output signal can only be scaled for instruments with analog output!

Setting range: 0 to 75% of the nominal measuring range

Factory setting: Initial value of measuring range

#### Example

The instrument has a nominal measuring range -400 ... +400 mbar  
The output signal of the instrument is 0 ...20 mA

Objective: The range from 0 to 200 mbar (customer's measuring range) will be represented on the output side by 0 ... 20 mA.

Setting: The initial value of scaling (Sc.Lo) = 0.000  
The final value of scaling (Sc.Hi) = 200.0

Result: At a pressure of less than 0 mbar the instrument reports an error (value below lower measuring range limit) and makes the corresponding error signal (0 mA) available at the output.  
At a pressure of 0 mbar the instrument makes 0 mA available at the output.  
At a pressure of +200 mbar the instrument makes 20 mA available at the output.  
At a pressure greater than +200 mbar the instrument reports an error (measuring range exceeded) and makes the corresponding error signal (22 mA) available at the output.

#### Setting

- \* Unlock the instrument, See section 7.2 "Unlocking the instrument (code entry)", page 27.
- \* "Rotate" until the bottom line shows "Sc.Lo".
- \* "Press"



"-" Flashing

Continuous



Enter the value "digit by digit."

# 7 Commissioning

---

## 7.8.2 Setting the final value of scaling (Sc.Hi)



The output signal can only be scaled for instruments with analog output!

Explanation See section 7.8.1 "Setting the starting value of scaling (Sc.Lo)", page 35.

---

Setting range: 25 to 100% of the nominal measuring range

Factory setting: Final value of measuring range

---

### Setting

- \* Unlock the instrument, See section 7.2 "Unlocking the instrument (code entry)", page 27.
- \* "Rotate" until the bottom line shows "Sc.Hi".
- \* "Press"



"-" Flashing

Continuous

---



Enter the value "digit by digit."

---

## 7.9 Setting the error signal (S.Err)



Only for instruments with analog output, an error signal is generated for overrange or underrange!

---

### Setting

- \* Unlock the instrument, See section 7.2 "Unlocking the instrument (code entry)", page 27.
- \* "Rotate" until the bottom line shows "S.Err".
- \* "Press"



Example

3.40nA =

For **underrange**

error signal = 0 mA for measuring range 0 ... 20 mA

error signal = 3.4 mA for measuring range 4 ... 20 mA

error signal = 0 V for measuring range 0 ... 10 V

22nA =

For **overrange**

error signal = 22 mA for measuring range 0 ... 20 mA

error signal = 22 mA for measuring range 4 ... 20 mA

error signal = 10.7 V for measuring range 0 ... 10 V

## 7.10 Setting the switching function (B.Fct)

### General

The response of the instrument's switching output can be selected:

- Hysteresis make contact
- Hysteresis break contact
- Window function make contact
- Window function break contact

### 7.10.1 Hysteresis

#### Relay behavior

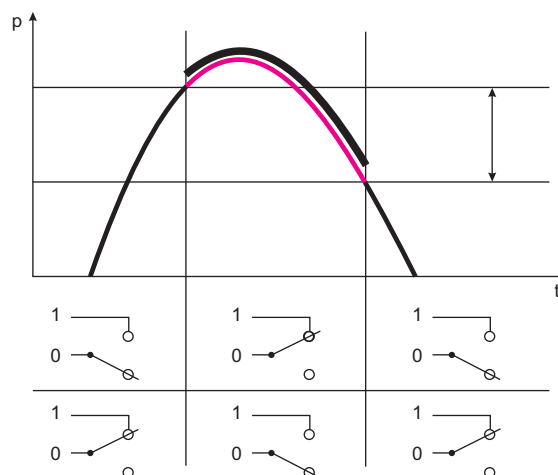

### Setting

- \* Unlock the instrument, See section 7.2 "Unlocking the instrument (code entry)", page 27.
- \* "Rotate" until the bottom line shows "B.Fct".
- \* "Press"

# 7 Commissioning

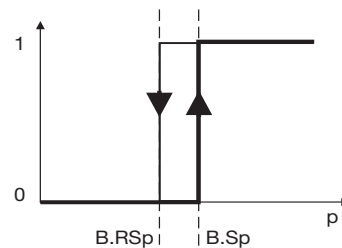
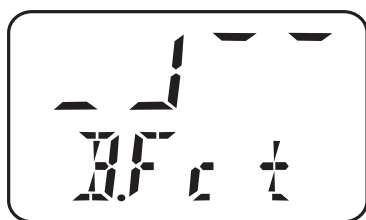

0 = Hysteresis of make contact (switching difference) (factory setting)

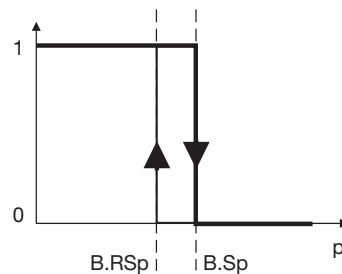
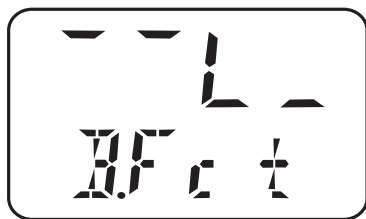

1 = Hysteresis of break contact (switching difference) = min. contact

## 7.10.2 Window

### Relay response

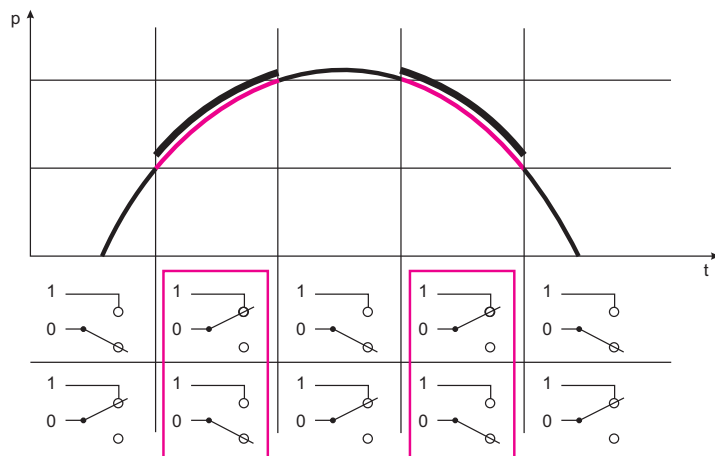

## 7 Commissioning

2 = Window function make contact

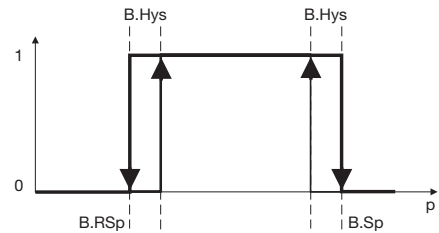
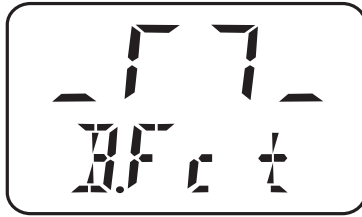

3 = Window function break contact

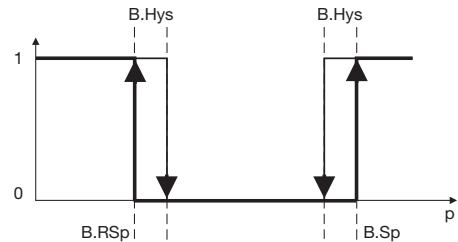
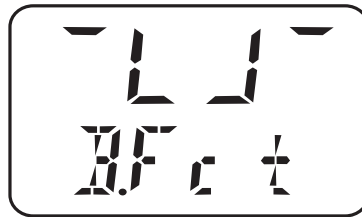

### 7.11 Setting the switching point (B.SP)

See section 7.10 "Setting the switching function (B.Fct)", page 37.

Setting range: 0 to 100% of the nominal measuring range

Factory setting: 50% of the nominal measuring range

#### Setting

- \* Unlock the instrument, See section 7.2 "Unlocking the instrument (code entry)", page 27.
- \* "Rotate" until the bottom line shows "B.SP".
- \* "Press"



"-" Flashing

Continuous



Enter the value "digit by digit."

## 7 Commissioning

---

### 7.12 Setting the reset point (B.RSP)

See section 7.10 "Setting the switching function (B.Fct)", page 37.

Setting range: 0 to 100% of the nominal measuring range

Factory setting: 40% of the nominal measuring range

---

#### Setting

- \* Unlock the instrument, See section 7.2 "Unlocking the instrument (code entry)", page 27.
- \* "Rotate" until the bottom line shows "B.RSP".
- \* "Press"

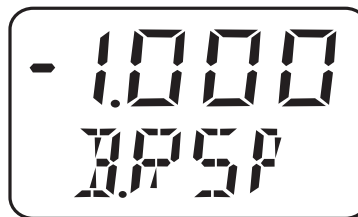

"-" Flashing

Continuous

---



Enter the value "digit by digit."

---

---

### 7.13 Setting the switching difference (hysteresis) (B.HYS)

See section 7.10 "Setting the switching function (B.Fct)", page 37.

Setting range: 0 to 100% of the nominal measuring range

Factory setting: 40% of the nominal measuring range

---

#### Setting

- \* Unlock the instrument, See section 7.2 "Unlocking the instrument (code entry)", page 27.
- \* "Rotate" until the bottom line shows "B.HYS".
- \* "Press"



"-" Flashing

Continuous

---



Enter the value "digit by digit."

---

---



### 7.14 Setting the switching delay (B.DLY)

Setting range: 0.00 to 99.99 s

Factory setting: 0.00 s

#### Setting

- \* Unlock the instrument, See section 7.2 "Unlocking the instrument (code entry)", page 27.
- \* "Rotate" until the bottom line shows "B.DLY".
- \* "Press"



"0" flashes

Continuous



Enter the value "digit by digit."

### 7.15 Setting the display alignment (D.Dir)

Setting range: std = standard = instrument upright  
turn = turned = instrument overhead

Factory setting: std

#### Setting

- \* Unlock the instrument, See section 7.2 "Unlocking the instrument (code entry)", page 27.
- \* "Rotate" until the bottom line shows "D.Dir".
- \* "Press"



or



# 7 Commissioning

---

## 7.16 Setting the display unit (D.Uni)

Setting range: Uni.P = pressure unit set as for "Uni.P", See section 7.4 "Selecting the unit of the measured value (Uni.P)", page 28.

Pro2 = percentage of scaled measuring range = "Sc.Hi" minus "Sc.Lo", See section 7.8.1 "Setting the starting value of scaling (Sc.Lo)", page 35 and See section 7.8.2 "Setting the final value of scaling (Sc.Hi)", page 36.

Factory setting: std

---

### Setting

- \* Unlock the instrument, See section 7.2 "Unlocking the instrument (code entry)", page 27.
- \* "Rotate" until the bottom line shows "D.Uni".
- \* "Press"



Uni.P = the measured value is displayed in the unit that was selected, See section 7.4 "Selecting the unit of the measured value (Uni.P)", page 28.

or

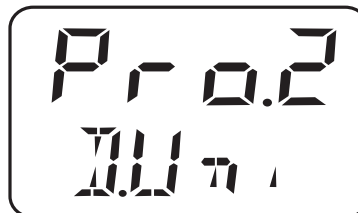

Pro.2 = the measured value is displayed as a percentage of the scaled measuring range, See section 7.8.1 "Setting the starting value of scaling (Sc.Lo)", page 35 and See section 7.8.2 "Setting the final value of scaling (Sc.Hi)", page 36.

---

### Example

The measuring range of the instrument was set to from -50 to +350 mbar and the scaled measuring range is 300 mbar.

If the instrument measures a pressure of +150 mbar, 50% is displayed.

---

### 7.17 Displaying the version of the operating device software (SW.Di)

Setting range: Read only

Factory setting: -

---

#### Setting

- \* Unlock the instrument, See section 7.2 "Unlocking the instrument (code entry)", page 27.
- \* "Rotate" until the bottom line shows "SW.Di".
- \* "Press"

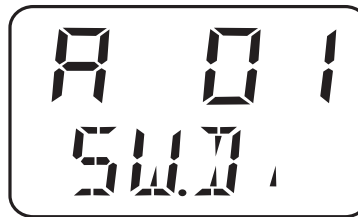

"Alternating"

---

### 7.18 Displaying the version of the signal stage software (SW.Si)

Setting range: Read only

Factory setting: -

---

#### Setting

- \* Unlock the instrument, See section 7.2 "Unlocking the instrument (code entry)", page 27.
- \* "Rotate" until the bottom line shows "SW.Sir".
- \* "Press"



"Alternating"

---

## 8 Calibration

---

### 8.1 Setting the zero point (offset)

#### 8.1.1 Automatic offset adjustment



Automatic offset adjustment is only possible for instruments with a relative pressure measuring range!

---

##### **On the instrument**

See section 7.5.1 "Automatic offset adjustment", page 31.

##### **By setup program**

not possible.

---

#### 8.1.2 Edited offset setting

##### **On the instrument**

See section 7.5.2 "Edited offset setting", page 31.

##### **By setup program**

Connect the instrument with the PC and start the setup program,  
See section 9 "Setup program", page 45 and following.

Input / offset.

---

## 9.1 Function

### Configurable parameters

The optionally available PC setup software (TN 20/00522384) can be used to operate the instrument conveniently from a PC.

Depending on the device design, the following settings are possible, for example:

- Measuring range and limits of measuring range.
- Response of outputs when the measuring range is exceeded.
- Functions of switching outputs K1 and K2.
- Setting special functions (for example tables for special linearizations).



Data can be transferred from or to the transmitter if it is connected to the power supply; See section 4 "Electrical connection", page 11 and following.

### Connection

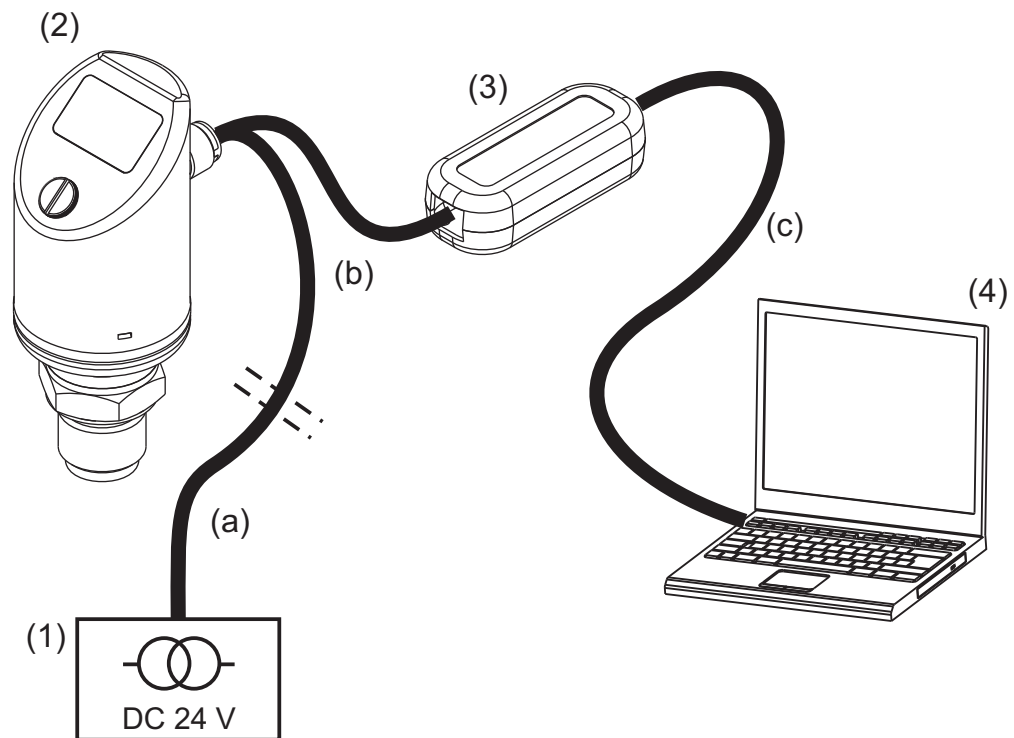

(1)	Power supply DC 24 V	(a)	4-pin cable socket (straight) M12x1 with 2-m PVC cable TN 40/00404585 or 4-pin angle box M12x1 with 2-m PVC cable TN 40/00409334
(2)	Pressure switch type 405052	(b)	Connecting cable TN 70/00507861
(3)	USB/TTL converter Part of TN 70/00456352	(c)	PC interface line (gray) Part of (3)
(4)	Notebook / PC		

## 9 Setup program

---

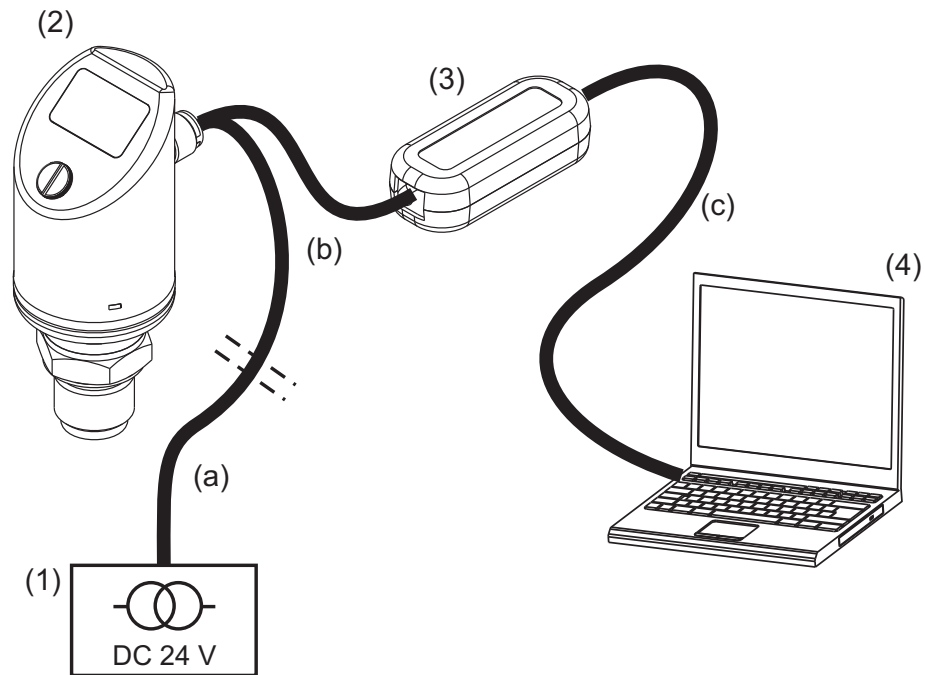

- \* Install the setup program software on the notebook / PC.



During the installation, the driver for the USB/TTL converter is also installed on the PC.

---

- \* Screw the connecting cable (b) onto the plug of the pressure switch (2).
- \* Connect the USB/TTL converter (3) to the connecting cable (b) and PC interface line (gray) (c).
- \* Connect the PC interface line (gray) (c) to the notebook (4).
- \* Connect the cable (a) to the power supply (1) and connecting cable (b).

### 9.2 Start the setup program

Start / Programs / JUMO instruments / Setup program JUMO DELOS K, SI,

HP



# 10 Eliminating errors and faults

## 10.1 Possible errors

Display	Possible cause	Measure
	<ul style="list-style-type: none"> <li>- Overrange or underrange</li> <li>- Broken sensor.</li> </ul>	Configure other measuring range, Chapter 7.4 "Selecting the unit of the measured value (Uni.P)".
	Device error: <ul style="list-style-type: none"> <li>- 1 = Internal communication error</li> <li>- 2 = Error analog output</li> <li>- 3 = Short circuit Switching output 1</li> <li>- 4 = Short circuit Switching output 2</li> <li>- 5 = VCC 8 V outside of working range</li> <li>- 6 to 8 = Internal communication error</li> <li>- 9 = Invalid configuration</li> </ul>	1), 6), 7), 8): Call Customer Service; see the back of the Operating Manual. 2): Check the ambient temperature. Check output for broken line. Output burden is too high (for current output) or too low (for voltage output). 3), 4): Check the corresponding switching output. 5): Check the power supply. 9): Check the configuration.
	Display overflow: Upper display: "- - - -" Lower display: Parameter name Value is less than -9999 or greater than 9999.	Check the corresponding switching output. Check the power supply.



# 11 Instrument description

## 11.1 Technical data

### General

<b>Reference conditions</b>	DIN 16086 and EN 60770
<b>Sensor system</b>	
Construction	Silicon sensor with stainless steel separating diaphragm
Pressure transfer medium	Synthetic oil, FDA-compliant
Permissible load change	more than 10 million
<b>Location</b>	
Mounting location	Any
Calibration location	Device standing vertically, process connection on bottom
Location-dependent zero point offset	Zero point correction possible locally or via setup (20% of nominal measuring range)
- Basic type extension 000 (standard design)	≤ 1 mbar
- Basic type extension 004 (for elevated medium temperature)	≤ 10 mbar
<b>Display</b>	
Type	Backlit LCD
Alignment	Display can be rotated 180° (via setup) Housing can be turned 320° (mechanically)
Size	Display field 16x26 mm / font size 7 mm / 2 x 4 places
Color	Normal operation:amber Error: red Setup mode: red
Switching state indicator	K1, K2
Measuring unit	mbar, bar, kPa, MPa, psi, %
<b>Operation</b>	
Local via setup	With accompanying combination tool or screwdriver 0.5x3 Pin 12 of the M12 round plug

# 11 Instrument description

## Input

All measuring ranges can be overloaded to -1 bar (vacuum-proof)

Relative pressure							
Measuring range	0.4	1	4	10	25	60	bar
Overload capacity	1.6	4	16	40	100	240	
Bursting pressure	2	5	20	50	125	300	
Measuring range	-0.4...0.4	-1...1	-1...3	-1...9	-1...24		bar
Overload capacity	1.6	4	16	40	100		
Bursting pressure	2	5	20	50	125		
Absolute pressure							
Measuring range	0.4	1	4	10	25	60	bar
Overload capacity	1.6	4	16	40	100	240	
Bursting pressure	2	5	20	50	125	300	

## Outputs

<b>Analog output</b>	
Freely configurable	4 ... 20 mA + 1 x PNP switching output standard 0 ... 20 mA + 1 x PNP switching output 0 ... 10 V + 1 x PNP switching output
Jump response $T_{90}$	$\leq 100$ ms
<b>Switching output</b>	
Number	1 x PNP switching output 2 x PNP switching output
Switching type	Break contact / make contact
Switching function	Window / hysteresis
<b>Switching capacity</b>	
- Voltage drop from $U_B$	PNP $\leq 2$ V
- Contact rating	On $\leq 250$ mA / Off $\leq 1$ mA
- Switching cycles	$> 10$ million
Response time	$\leq 20$ ms
Short-circuit proof	Yes
<b>Current load check</b>	
- Time interval	2 s; $T_{ON}$ 40 ms
- Periodic protective circuit in case of overcurrent	f=0.5 Hz Display: Err3 switching output K1, Err4 switching output K2
<b>Setting range</b>	
Analog output	Turn down 1:4

# 11 Instrument description

<b>Switching output</b>	
- Switching point	Configurable in the nominal measuring range (> reset point)
- Reset point	Configurable in the nominal measuring range (< switching point)
- Hysteresis	Configurable in the nominal measuring range
- Damping	99.99 sec
- Delay	99.99 sec
<b>Burden</b>	
4 to 20 mA	$R_i \geq (UB-6.5 \text{ V}) / 0.022 \text{ A}$
0 to 20 mA	$R_i \geq (UB-6.5 \text{ V}) / 0.022 \text{ A}$
0 to 10 V	$R \geq 10 \text{ k}\Omega$

## Mechanical properties

<b>Process connection</b>	
Material	Stainless steel 316L
Surface	$R_a \leq 0.8 \mu\text{m}$
Process seal	All flange connections are welded and therefore have no seals
- Process connection 521, 523, 571, 575, 576, 652	FPM standard
- Process connection 997 (JUMO PEKA)	FPM, VMQ (silicon), EPDM also available, see Data Sheet 40.9711
<b>Measurement diaphragm</b>	
Material	Stainless steel 316L
Surface	$R_a \leq 0.8 \mu\text{m}$
<b>Enclosure</b>	
Material	Stainless steel 316L
Surface	$R_a \leq 0.8 \mu\text{m}$
Threaded sleeve M12x1	Stainless steel 316L
Enclosure seal	VMQ (silicon)
Display	PA
<b>Screw plug</b>	
Material	Aluminum 3.2315
Surface	Eloxal coating
Enclosure seal	VMQ (silicon)
<b>Weight</b>	0.2 kg with process connection 504 (G1/2)

# 11 Instrument description

---

## Ambient conditions

<b>Permissible temperatures</b> Measuring material - for basic type extension 004 Environment - Ambient temperature -50°C Storage	-25 ... +100°C (+135°C max. 1 hour per day) -25 ... +200°C -25 ... +75°C Restricted function: Stationary use only, danger of broken cable, display does not function -40 ... +85°C
<b>Permissible relative humidity</b> - in operation - in storage	100% incl. condensation on instrument outer sleeve 90% without condensation
<b>Permissible mechanical loading</b> - Vibration strength - Shock resistance	20 g, 10 ... 2000 Hz per IEC 60068-2-6 50 g for 11 ms / 100 g for 1 ms per IEC 60068-2-27
<b>Electromechanical compatibility</b> - Interference emission - Interference immunity	(Only with 4-pin connecting cable and grounded enclosure) Class A per EN 61326 Performance characteristic A per EN 61326
<b>Protection</b>	IP 67 to DIN 60529

# 11 Instrument description

## Accuracy

Relative pressure							
Nominal (rated) measuring range	0.4	1	4	10	25	60	bar
<b>Linearity<sup>1</sup></b>	<b>0.15</b>	<b>0.15</b>	<b>0.1</b>	<b>0.1</b>	<b>0.1</b>	<b>0.1</b>	% of end val. of nom. mess. range
Accuracy at +20°C <sup>2</sup>	0.35	0.3	0.25	0.25	0.25	0.25	% of end val. of nom. mess. range
Accuracy at -20...+75°C <sup>3</sup>	0.7	0.6	0.5	0.5	0.5	0.5	% of end val. of nom. mess. range
Absolute pressure							
Nominal (rated) measuring range	-0.4...0.4	-1...1	-1...3	-1...9	-1...24		bar
<b>Linearity<sup>1</sup></b>	<b>0.15</b>	<b>0.15</b>	<b>0.1</b>	<b>0.1</b>	<b>0.1</b>		% of end val. of nom. mess. range
Accuracy at +20°C <sup>2</sup>	0.35	0.3	0.25	0.25	0.25		% of end val. of nom. mess. range
Accuracy at -20...+75°C <sup>3</sup>	0.7	0.6	0.5	0.5	0.5		% of end val. of nom. mess. range
Long-term stability	0.2% with reference conditions to EN 61298-1						

<sup>1</sup> Linearity based on limit point setting

<sup>2</sup> Includes: linearity, hysteresis, repeatability, deviation from initial and final values of measuring range.

<sup>3</sup> Includes: linearity, hysteresis, repeatability, deviation from initial and final values of measuring range, thermal effect on initial value of measuring range and span.







**JUMO GmbH & Co. KG**

Street address:  
Moritz-Juchheim-Straße 1  
36039 Fulda, Germany  
Delivery address:  
Mackenrodtstraße 14  
36039 Fulda, Germany  
Postal address:  
36035 Fulda, Germany  
Phone: +49 661 6003-0  
Fax: +49 661 6003-607  
E-mail: [mail@jumo.net](mailto:mail@jumo.net)  
Internet: [www.jumo.net](http://www.jumo.net)

**JUMO Instrument Co. Ltd.**

JUMO House  
Temple Bank, Riverway  
Harlow - Essex CM20 2DY, UK  
Phone: +44 1279 63 55 33  
Fax: +44 1279 63 52 62  
E-mail: [sales@jumo.co.uk](mailto:sales@jumo.co.uk)  
Internet: [www.jumo.co.uk](http://www.jumo.co.uk)

**JUMO Process Control, Inc.**

8 Technology Boulevard  
Canastota, NY 13032, USA  
Phone: 315-697-JUMO  
1-800-554-JUMO  
Fax: 315-697-5867  
E-mail: [info@jumo.us](mailto:info@jumo.us)  
Internet: [www.jumo.us](http://www.jumo.us)