

Bracket 60/60

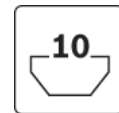

- Profile finishing: not required





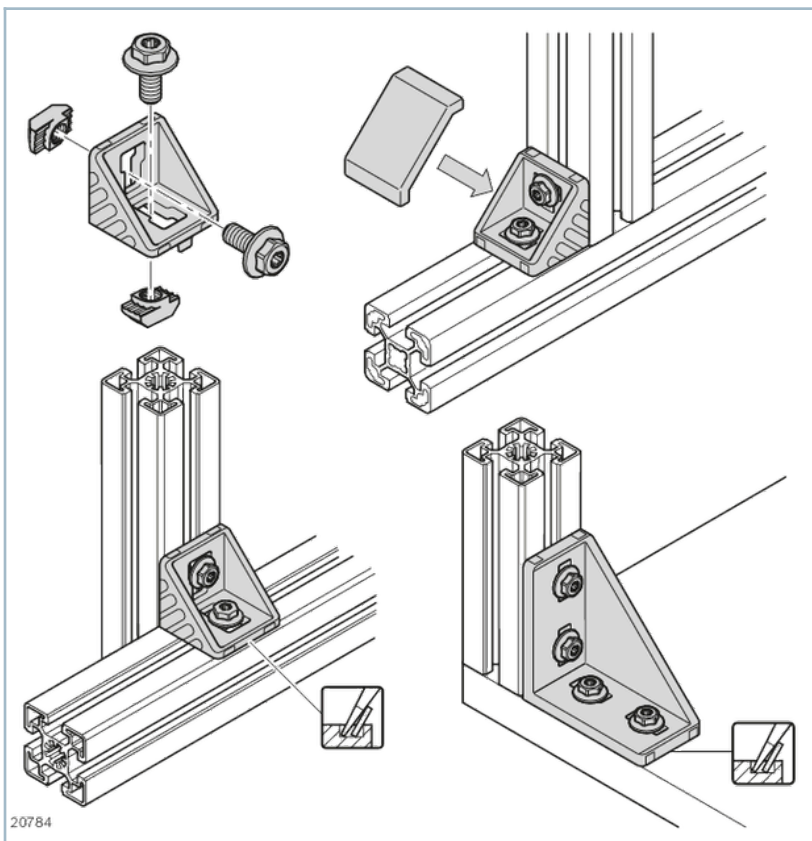
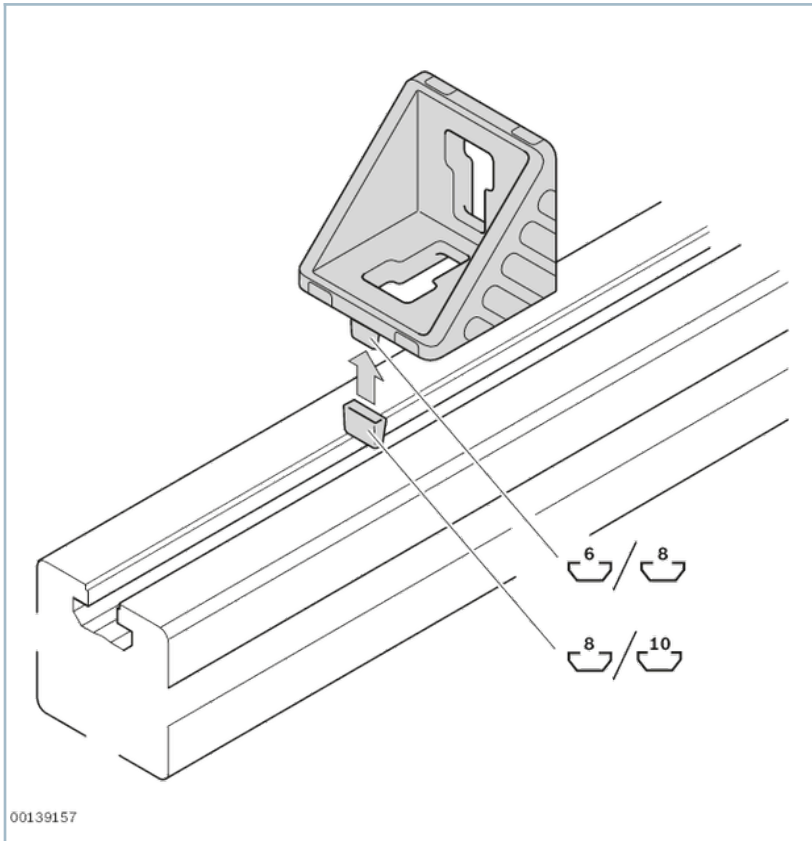

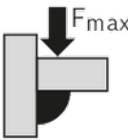
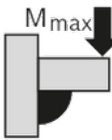
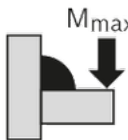

- Brackets with centering lugs for rapid, precise assembly with protection against turning
- Centering lugs can be easily broken off for assembly on plates or at right angles to the slot
- Version *designLINE* with special silver paint (RAL 9006) for an especially high-quality design
- Intermediate element for positioning brackets in the next largest slot
- Cover cap to protect from dirt, available in signal gray (RAL 7004) and black ESD (RAL 9005)

Product description



Connection elements, selection criteria

Technical data

	Groove	ES D	Material entry			
				F_{max}	M_{max}	M_{max}
				N	Nm	Nm
Bracket	8		Bracket: Diecast aluminum, vibratory ground Fastening material: steel; galvanized	5000	320	370
	8; 10		Bracket: Diecast aluminum, vibratory ground Fastening material: steel; galvanized	5000	320	370
	10		Bracket: Diecast aluminum, vibratory ground Fastening material: steel; galvanized	3000	125	150
	8		Bracket <i>designLINE</i> : Diecast aluminum; vibratory ground, painted (RAL 9006) Fastening material: steel; galvanized	5000	320	370
	8; 10		Bracket <i>designLINE</i> : Diecast aluminum; vibratory ground, painted (RAL 9006) Fastening material: steel; galvanized	5000	320	370
	10		Bracket <i>designLINE</i> : Diecast aluminum; vibratory ground, painted (RAL 9006) Fastening material: steel; galvanized	3000	125	150
	8		Bracket: Diecast aluminum, vibratory ground	5000	320	370
Cover cap for bracket			PP			
			PP			
Intermediate element for 10 mm slot	8; 10		PA; black			



M_{max}
Nm
110
110
110
110
110

Typ	Nut				
60 / 60	8	5000 N	320 Nm	370 Nm	110 Nm
	10	3000 N	125 Nm	150 Nm	-

Dimensions

Bracket 60/60 with cover cap

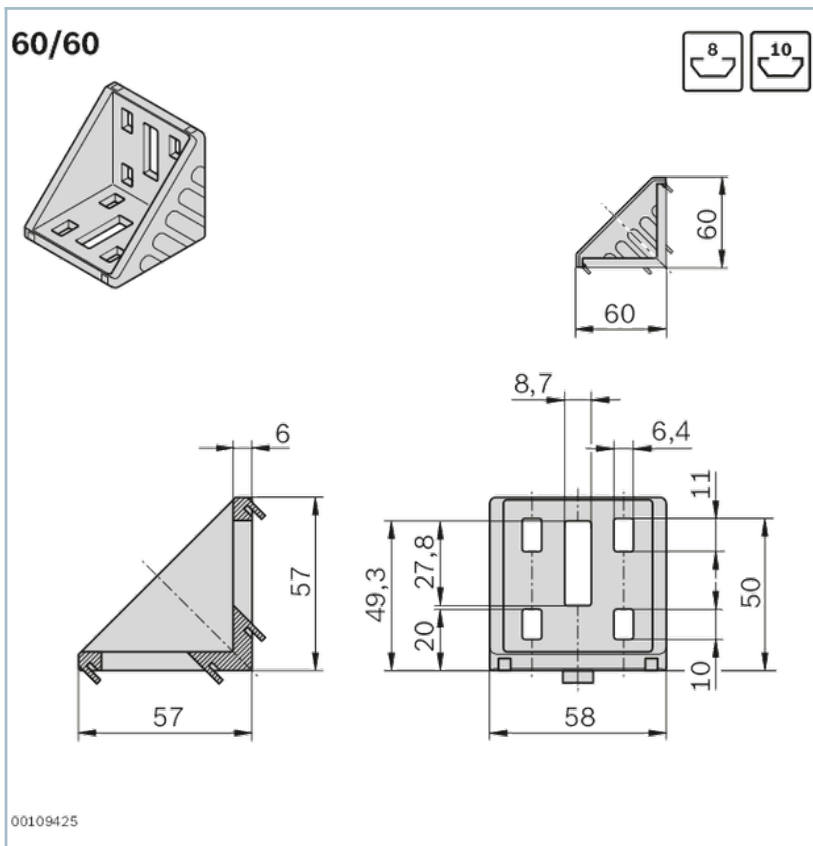

Accessories









Recommended accessories

- Intermediate element for 10 mm slot
- Cover cap for bracket 60/60, signal gray
- Cover cap for bracket 60/60, black

Delivery notes

FS2	FS5
<p>DIN 7984 M6x14</p> <p>8</p>	<p>M8x20</p> <p>10</p>

Ordering codes

	Groove	ESD	FS	No.
Bracket 60x60 set (standard) N8	8		8xFS2	3842523549
Bracket 60x60 set (standard) N8/10	8; 10		4xFS2, 1xFS5	3842523551
Bracket 60x60 set (standard) N10/10	10		2xFS5	3842523553
Bracket 60x60 set design <i>LINE</i> , N8/8	8		8xFS2	3842551609
Bracket 60x60 set design <i>LINE</i> , N8/10	8; 10		4xFS2, 1xFS5	3842551610
Bracket 60x60 set design <i>LINE</i> , N10/10	10		2xFS5	3842551611
Bracket (standard) 60x60	8			3842523546
Cover cap for bracket 60/60, signal gray				3842548852
Cover cap for bracket 60/60, black				3842548853
Intermediate element for 10 mm slot	8; 10			3842523537