



Hardware Description and Design-In Proposals for Single and Dual SMD Transmissive Sensors

By Reinhard Schaar

TCPT1300X01 (SINGLE), TCUT1300X01 (DUAL)



- AEC-Q101 qualified
- Transmissive sensor for automotive and industrial applications
- Gap dimension: 3 mm and aperture width: 0.3 mm
- Typical output current under test: $I_C = 0.6 \text{ mA}$ at $I_F = 15 \text{ mA}$
- Emitter wavelength: 950 nm
- Moisture sensitivity level 1 (MSL): unlimited floor life
- Halogen-free

TCPT1350X01 (SINGLE), TCUT1350X01 (DUAL)



- AEC-Q101 qualified
- Transmissive sensor for automotive and industrial applications
- Gap dimension: 3 mm and aperture width: 0.3 mm
- Typical output current under test: $I_C = 1.6 \text{ mA}$ at $I_F = 15 \text{ mA}$
- Emitter wavelength: 950 nm
- Moisture sensitivity level 1 (MSL): unlimited floor life
- Halogen-free
- Released for high operating temperatures up to 125 °C

TCPT1600X01 (SINGLE), TCUT1600X01 (DUAL)



- AEC-Q101 qualified
- Transmissive sensor for automotive and industrial applications
- Gap dimension: 3 mm and aperture width: 0.3 mm
- Typical output current under test: $I_C = 1.6 \text{ mA}$ at $I_F = 15 \text{ mA}$
- Emitter wavelength: 950 nm
- Moisture sensitivity level 1 (MSL): unlimited floor life
- Halogen-free
- Taller dome, more vertical headroom

APPLICATION NOTE

Hardware Description and Design-In Proposals for Single and Dual SMD Transmissive Sensors

RELATIVE COLLECTOR CURRENT VS. HORIZONTAL DISPLACEMENT

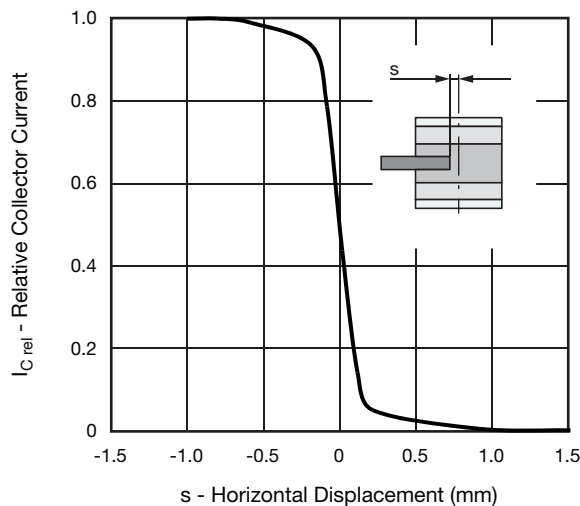
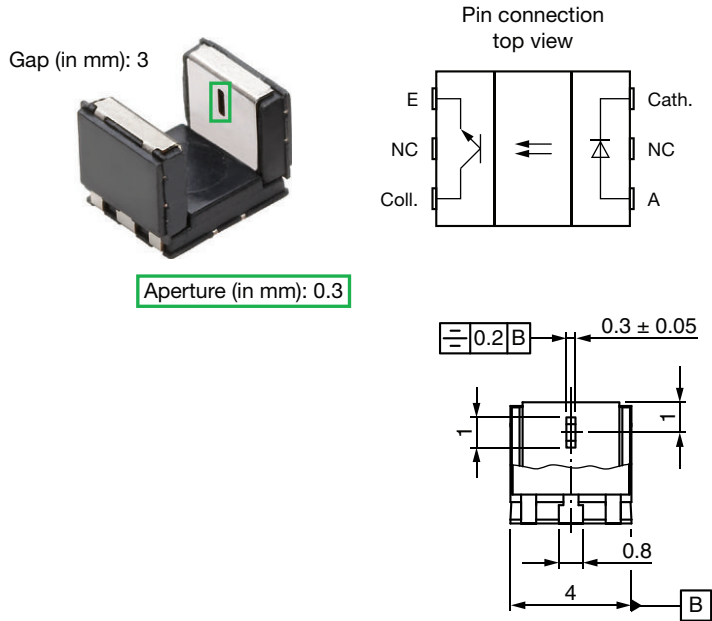

Relative Collector Current vs. Horizontal Displacement

Hardware Description and Design-In Proposals for Single and Dual SMD Transmissive Sensors

RELATIVE COLLECTOR CURRENT VS. HORIZONTAL DISPLACEMENT

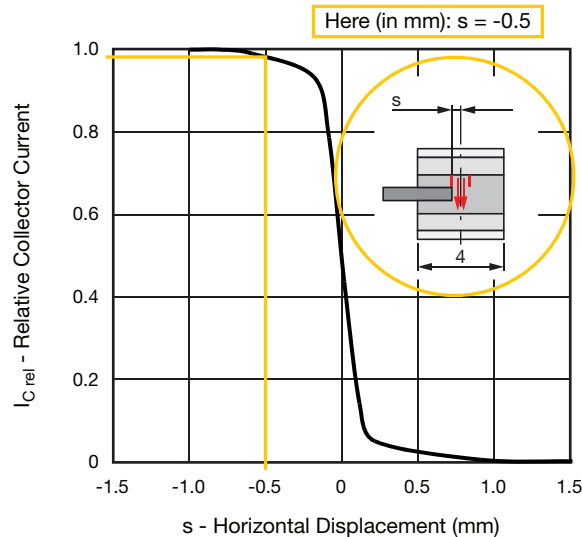
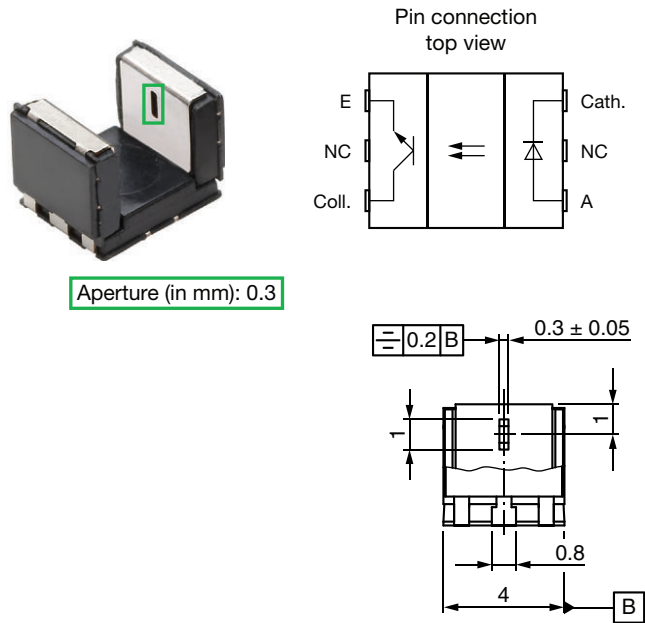

Relative Collector Current vs. Horizontal Displacement

With $s = -0.5$ mm, nearly all emitted IR light is also available at the detector side.

Hardware Description and Design-In Proposals for Single and Dual SMD Transmissive Sensors

RELATIVE COLLECTOR CURRENT VS. HORIZONTAL DISPLACEMENT

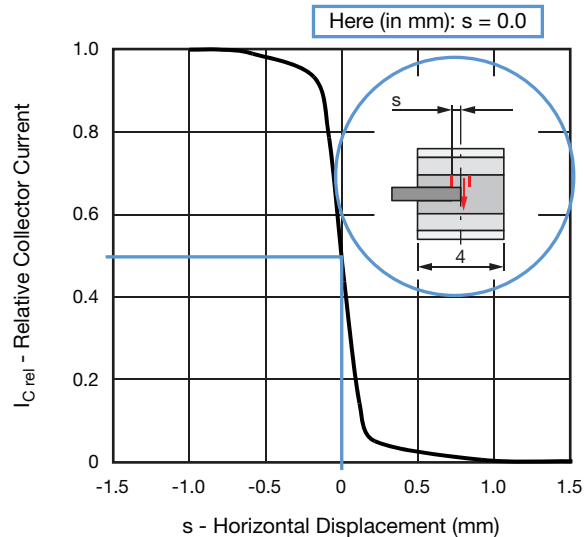
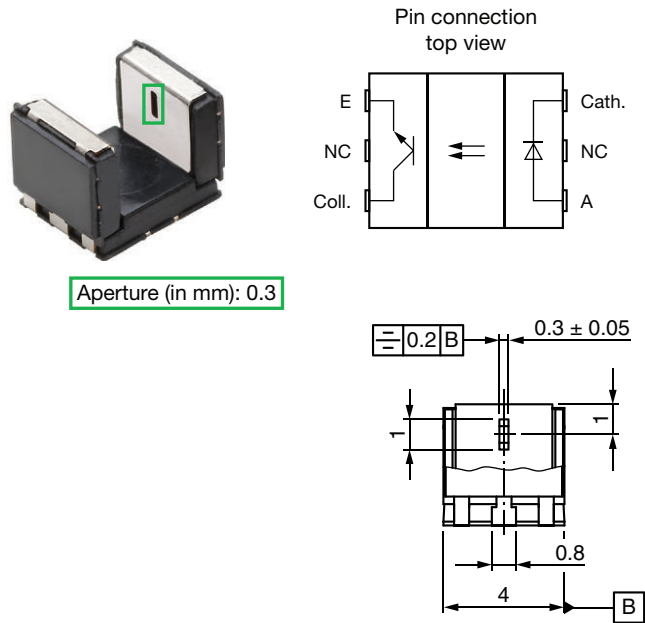

Relative Collector Current vs. Horizontal Displacement

With $s = 0$ mm, nearly half of emitted IR light is blocked, but half of IR light is also available at the detector side.

Hardware Description and Design-In Proposals for Single and Dual SMD Transmissive Sensors

RELATIVE COLLECTOR CURRENT VS. HORIZONTAL DISPLACEMENT

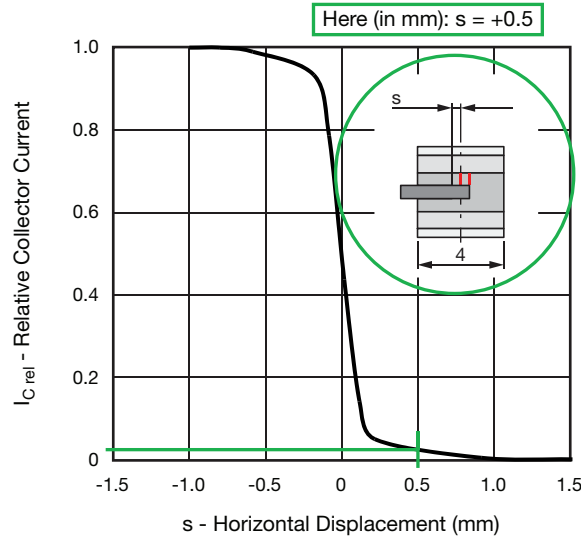
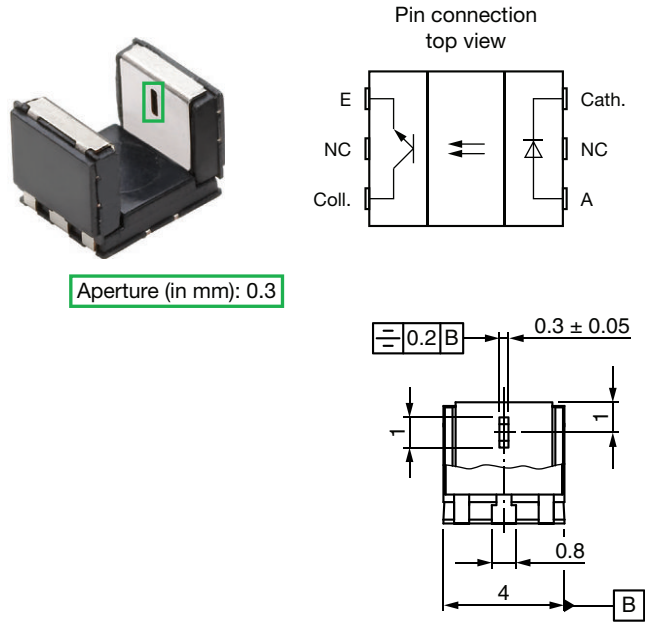

Relative Collector Current vs. Horizontal Displacement

With $s = +0.5$ mm, nearly all emitted IR light is blocked and nearly nothing is available at the detector side.

Hardware Description and Design-In Proposals for Single and Dual SMD Transmissive Sensors

RELATIVE COLLECTOR CURRENT VS. HORIZONTAL DISPLACEMENT

Transmissive Sensor: TCUT13.0X01

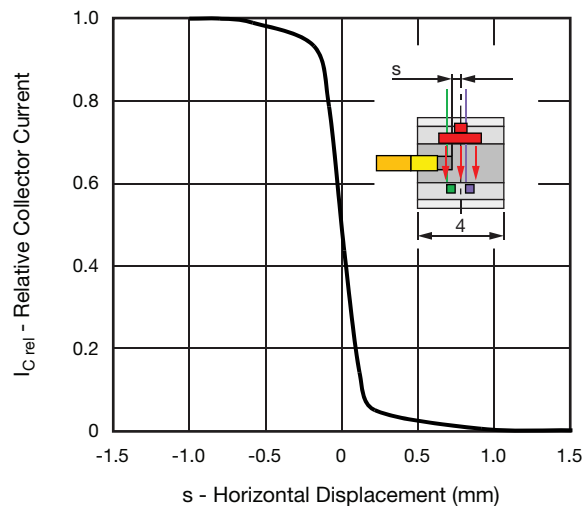
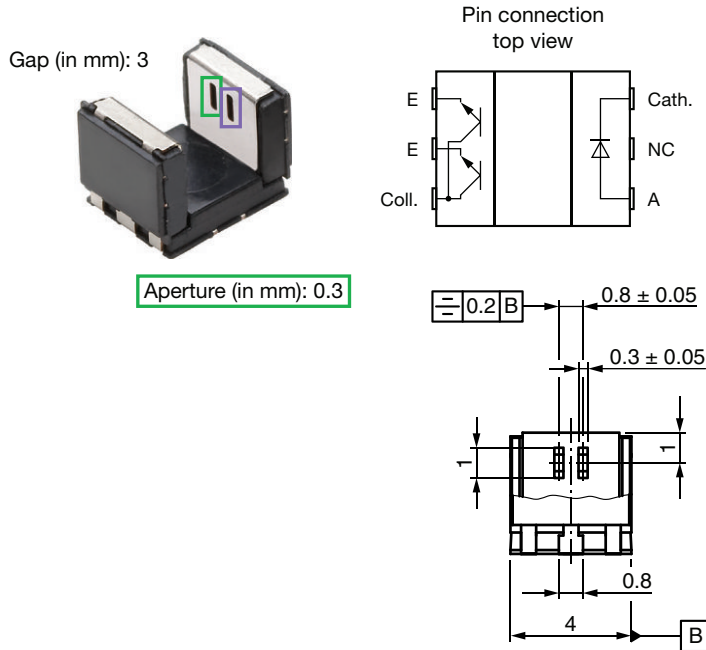

Relative Collector Current vs. Horizontal Displacement

Distance between slots for detector 1 (D_1) and detector 2 (D_2) is 0.5 mm.

Hardware Description and Design-In Proposals for Single and Dual SMD Transmissive Sensors

RELATIVE COLLECTOR CURRENT VS. HORIZONTAL DISPLACEMENT

Transmissive Sensor: TCUT13.0X01

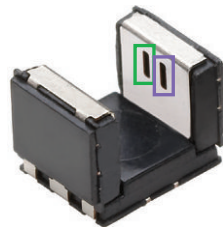

Aperture (in mm): 0.3

Pin connection
top view

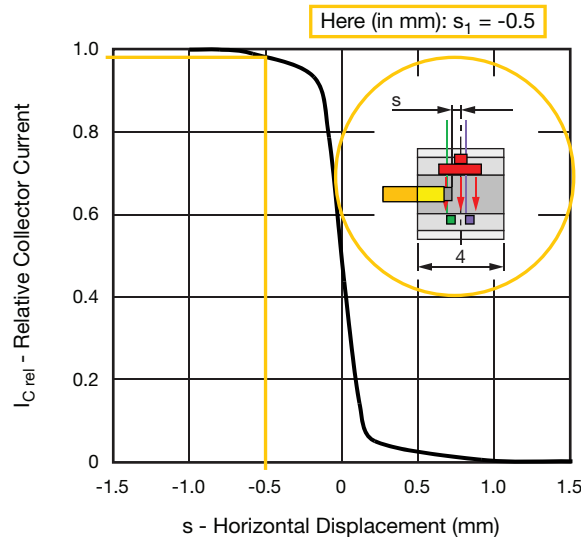
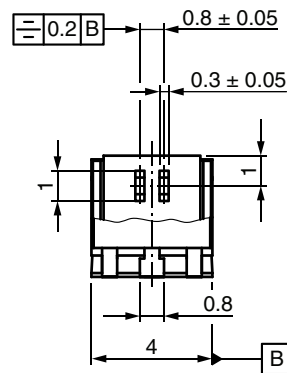
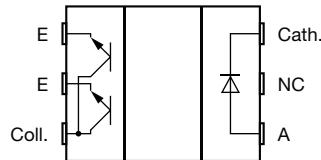

Relative Collector Current vs. Horizontal Displacement

With $s_1 = -0.5$ mm, nearly all emitted IR light is also available at both detector sides D_1 and D_2 : $U_{D1} = 1$, $U_{D2} = 1$

Hardware Description and Design-In Proposals for Single and Dual SMD Transmissive Sensors

RELATIVE COLLECTOR CURRENT VS. HORIZONTAL DISPLACEMENT

Transmissive Sensor: TCUT13.0X01

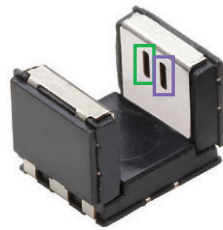

Aperture (in mm): 0.3

Pin connection
top view

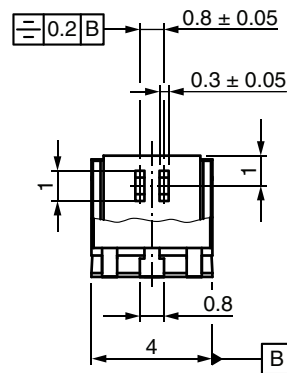
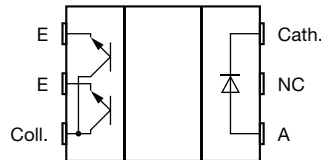

Here (in mm): $s_1 = 0.0$

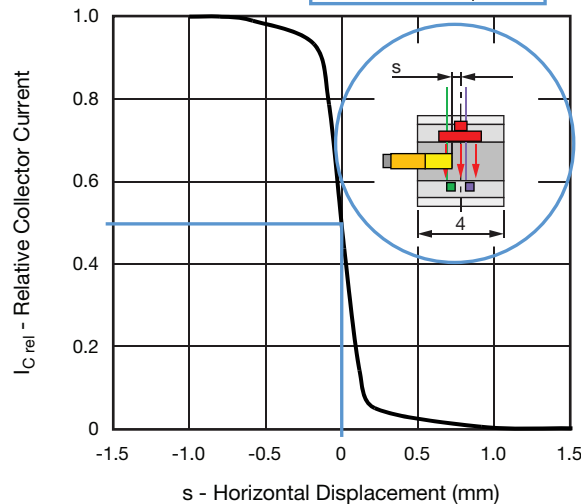

Relative Collector Current vs. Horizontal Displacement

With $s_1 = 0.0$ mm, nearly half of emitted IR light is blocked (for D_1), but half of IR light is also available at D_1 and all IR light is available at D_2 .

Hardware Description and Design-In Proposals for Single and Dual SMD Transmissive Sensors

RELATIVE COLLECTOR CURRENT VS. HORIZONTAL DISPLACEMENT

Transmissive Sensor: TCUT13.0X01

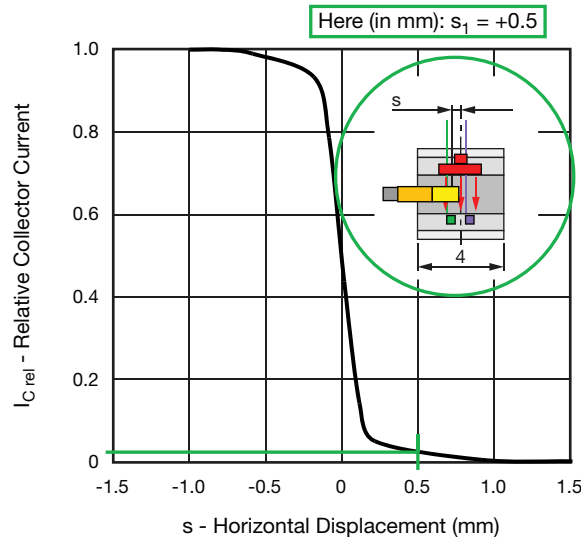
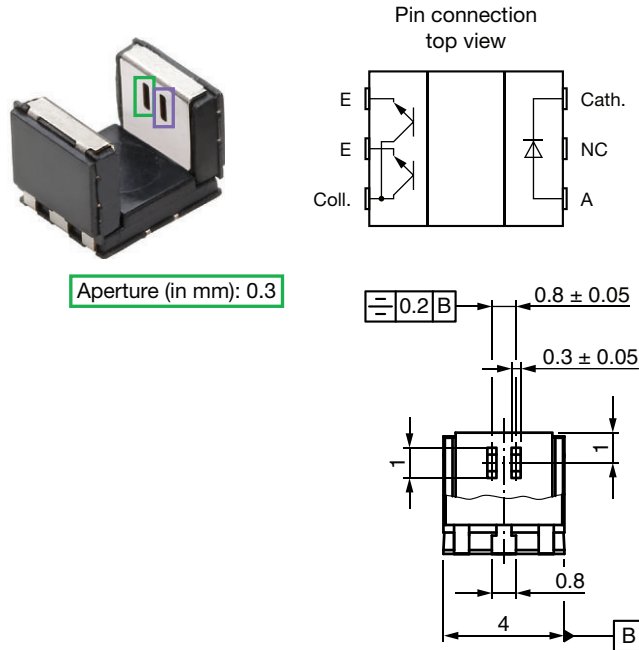

Relative Collector Current vs. Horizontal Displacement

With $s_1 = +0.5$ mm, nearly all IR light is blocked (for D_1), but all IR light still available at D_2 : $U_{D1} = 0$, $U_{D2} = 1$

Hardware Description and Design-In Proposals for Single and Dual SMD Transmissive Sensors

RELATIVE COLLECTOR CURRENT VS. HORIZONTAL DISPLACEMENT

Transmissive Sensor: TCUT13.0X01

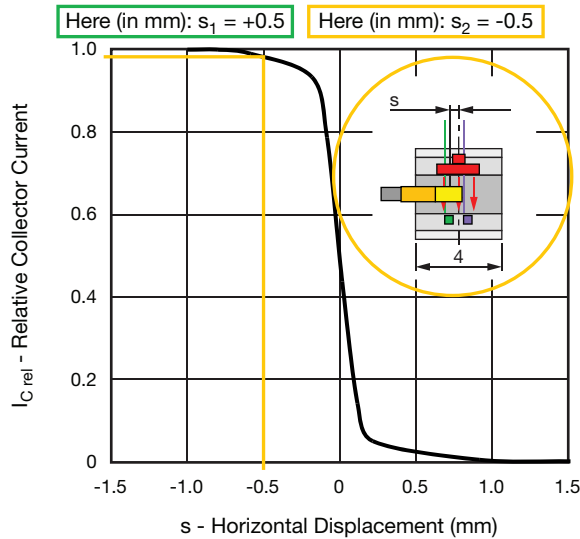
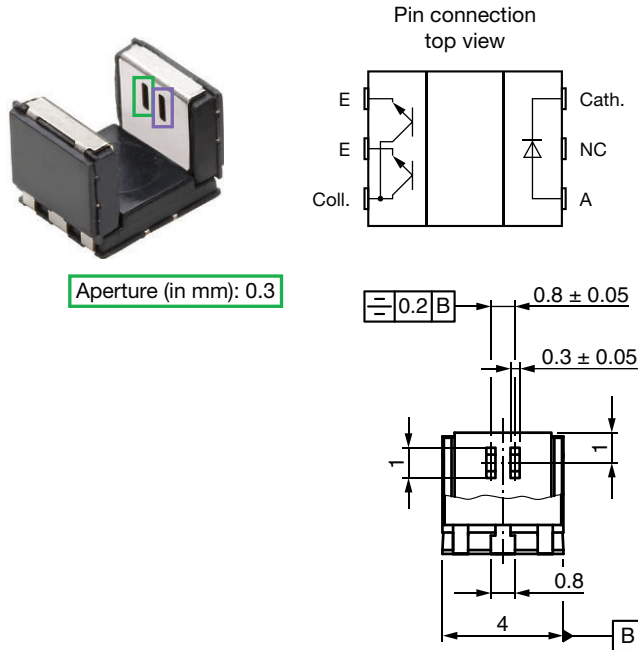

Relative Collector Current vs. Horizontal Displacement

With $s_2 = -0.5$ mm, nearly all emitted IR light is available at D_2 .

APPLICATION NOTE

Hardware Description and Design-In Proposals for Single and Dual SMD Transmissive Sensors

RELATIVE COLLECTOR CURRENT VS. HORIZONTAL DISPLACEMENT

Transmissive Sensor: TCUT13.0X01

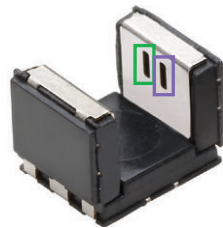

Aperture (in mm): 0.3

Pin connection
top view

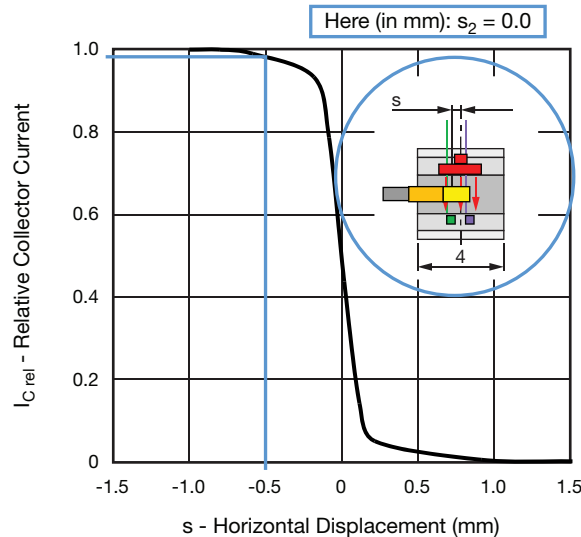
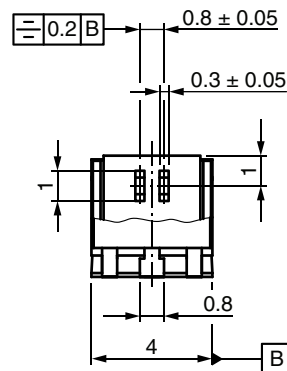
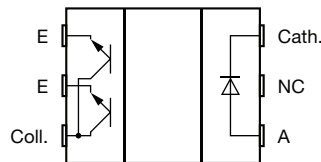

Relative Collector Current vs. Horizontal Displacement

With $s_2 = 0.0$ mm, nearly half of emitted IR light is blocked for D_2 .

Hardware Description and Design-In Proposals for Single and Dual SMD Transmissive Sensors

RELATIVE COLLECTOR CURRENT VS. HORIZONTAL DISPLACEMENT

Transmissive Sensor: TCUT13.0X01

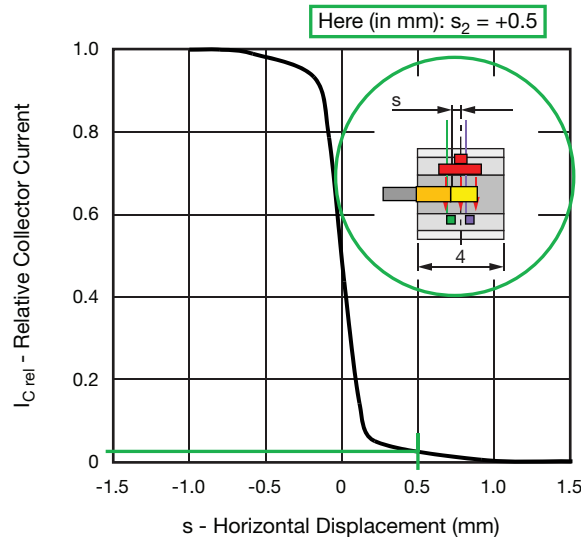
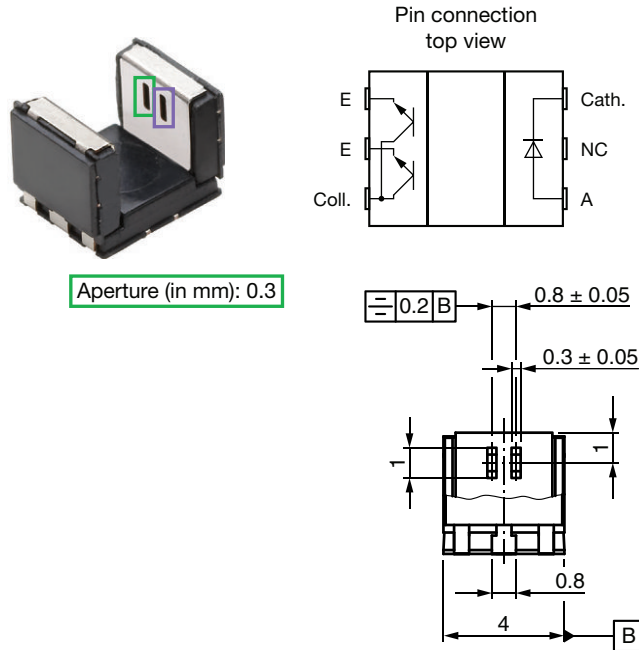

Relative Collector Current vs. Horizontal Displacement

With $s_2 = +0.5$ mm, nearly all emitted IR light is now also blocked for D_2 :
 $U_{D1} = 0, U_{D2} = 0$

Hardware Description and Design-In Proposals for Single and Dual SMD Transmissive Sensors

RELATIVE COLLECTOR CURRENT VS. HORIZONTAL DISPLACEMENT

Transmissive Sensor: TCUT13.0X01

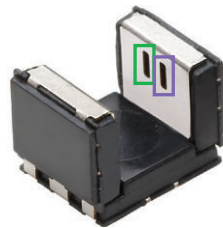

Aperture (in mm): 0.3

Pin connection
top view

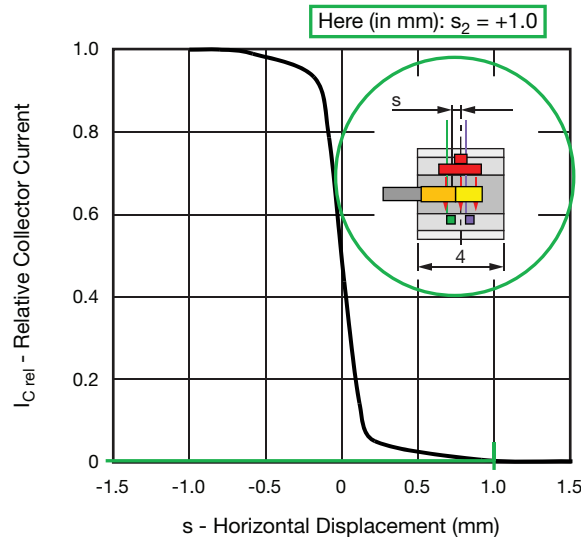
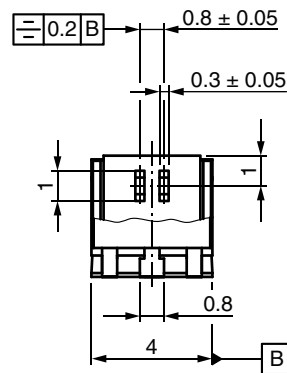
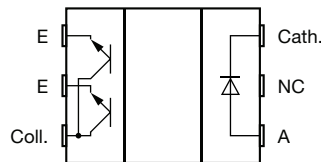

Relative Collector Current vs. Horizontal Displacement

With $s_2 = +1.0$ mm, all emitted IR light is now also blocked for D_2 :
 $U_{D1} = 0, U_{D2} = 0$

Hardware Description and Design-In Proposals for Single and Dual SMD Transmissive Sensors

RELATIVE COLLECTOR CURRENT VS. HORIZONTAL DISPLACEMENT

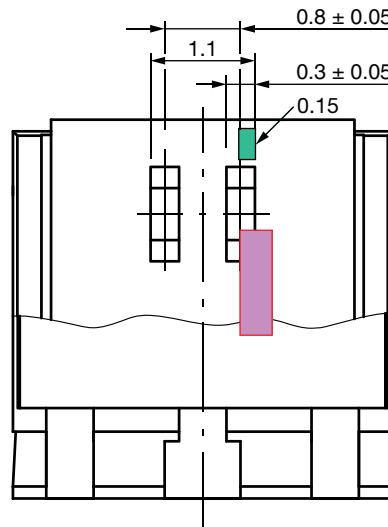

For $s = 0.5$ (in mm):
 $0.5 - 0.15 = 0.35$

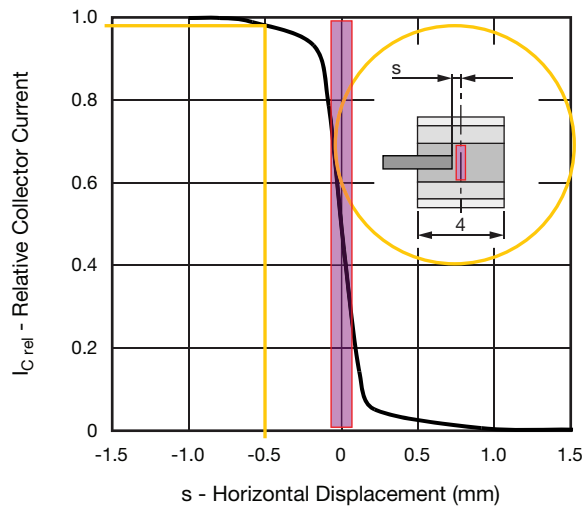

Relative Collector Current vs. Horizontal Displacement

With $s = \pm 0.5$ mm for close to 100 % / 0 % of the collector current, just ± 0.35 mm is seen as added overlapping that needs to be added to that 1.1 mm total width. So, $1.1 \text{ mm} + 2 \times 0.35 \text{ mm} = 1.8 \text{ mm}$ for the total closing / opening.

Hardware Description and Design-In Proposals for Single and Dual SMD Transmissive Sensors

RELATIVE COLLECTOR CURRENT VS. HORIZONTAL DISPLACEMENT

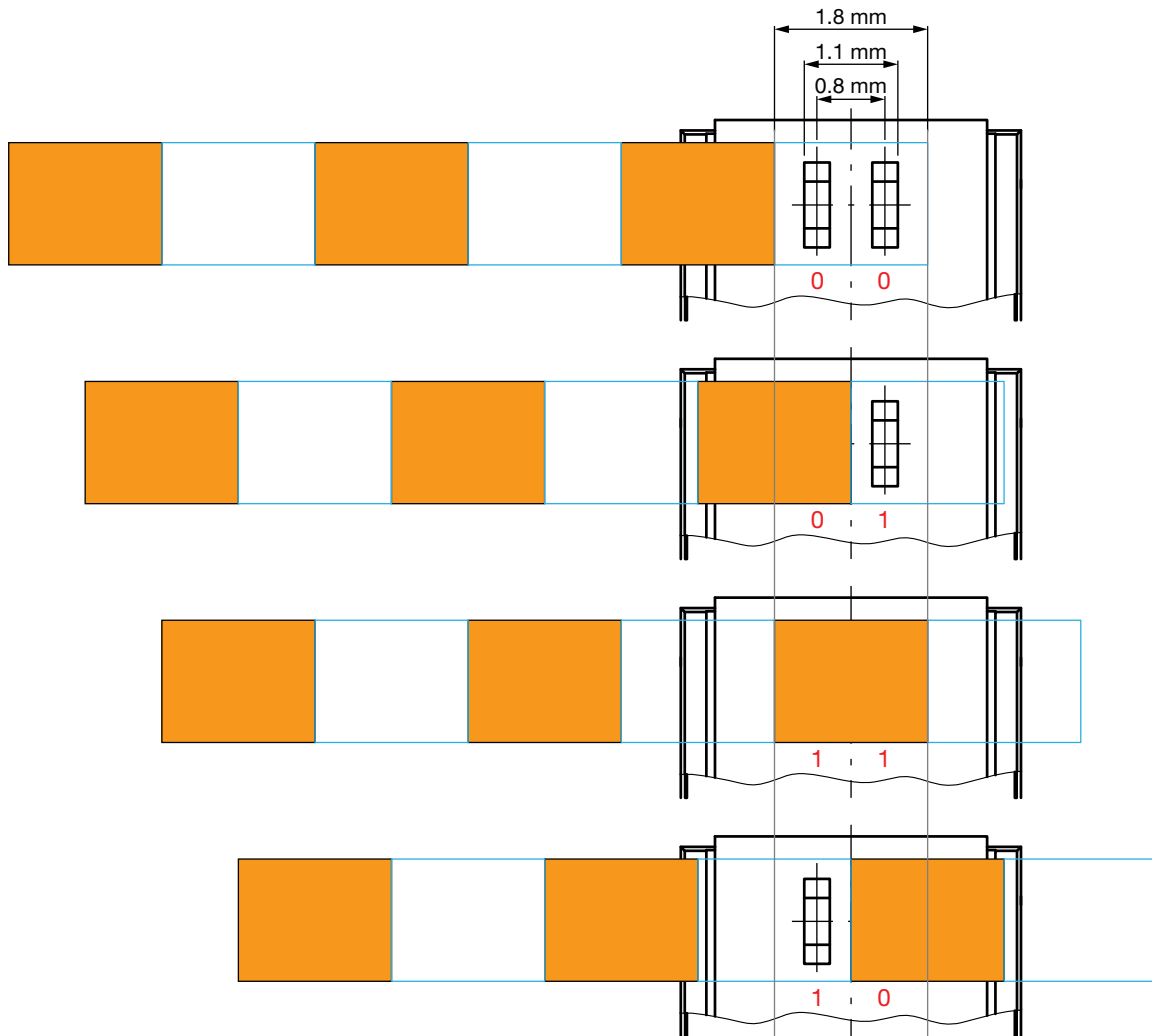

With a 1.8 mm hole, 1.8 mm gaps / balks, and a constant shift of 0.9 mm, all four positions will be covered well.

With 64 holes and balks = $64 \times 3.6 \text{ mm} = 230.4 \text{ mm}$.

A code wheel diameter will have with this: $d \approx 73 \text{ mm}$.

Smaller wheels are also possible, but the exact high and low level will not be reached.

With 0.6 mm holes, 0.5 mm gaps / balks, and with 64 holes and balks it could be just about 22 mm, and with just 16 position $(16 \times 1.1 \text{ mm}/\pi) = 5.6 \text{ mm}$ diameter.

Hardware Description and Design-In Proposals for Single and Dual SMD Transmissive Sensors

DETERMINING THE FORWARD CURRENT FOR THE IRED AND THE LOAD RESISTOR FOR THE PHOTOTRANSISTOR

First of all, one needs to also see the minimum specified and guaranteed values within basic characteristics of the datasheet:

| BASIC CHARACTERISTICS ($T_{amb} = 25\text{ }^{\circ}\text{C}$, unless otherwise specified) | | | | | | |
|--|--|--------|------|------|------|------|
| TCUT1300X01, TCPT1300X01 | | | | | | |
| PARAMETER | TEST CONDITION | SYMBOL | MIN. | TYP. | MAX. | UNIT |
| COUPLER | | | | | | |
| Collector current | $V_{CE} = 5\text{ V}$, $I_F = 15\text{ mA}$ | I_C | 0.3 | 0.6 | - | mA |

The TCUT1300X01 and TCPT1300X01 show here 0.3 mA (with an $I_F = 15\text{ mA}$), while the TCUT1350X01, TCPT1350X01, TCUT1600X01, and TCPT1600X01 show 0.7 mA:

| BASIC CHARACTERISTICS ($T_{amb} = 25\text{ }^{\circ}\text{C}$, unless otherwise specified) | | | | | | |
|--|--|--------|------|------|------|------|
| TCUT1350X01, TCPT1350X01, TCUT1600X01, TCPT1600X01 | | | | | | |
| PARAMETER | TEST CONDITION | SYMBOL | MIN. | TYP. | MAX. | UNIT |
| COUPLER | | | | | | |
| Collector current | $V_{CE} = 5\text{ V}$, $I_F = 15\text{ mA}$ | I_C | 0.7 | 1.6 | - | mA |

TCUT1300X01, TCPT1300X01

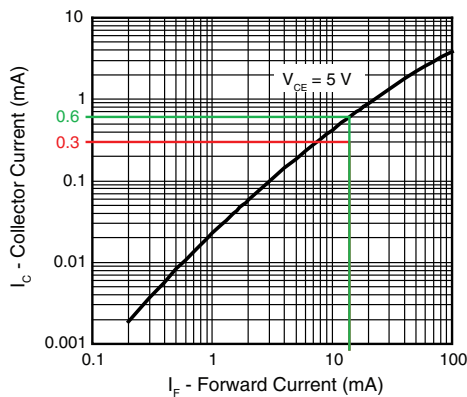

Fig. 1 - Collector Current vs. Forward Current

TCUT1350X01, TCPT1350X01,
TCUT1600X01, TCPT1600X01

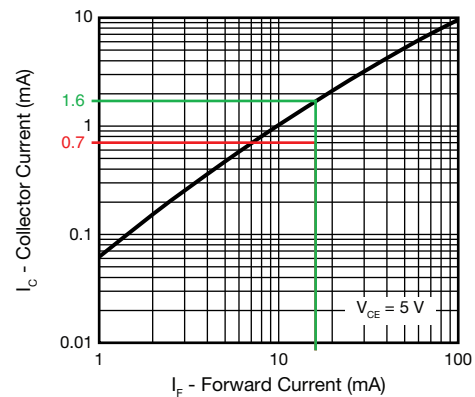

Fig. 2 - Collector Current vs. Forward Current

Hardware Description and Design-In Proposals for Single and Dual SMD Transmissive Sensors

DETERMINING THE FORWARD CURRENT FOR THE IRED AND THE LOAD RESISTOR FOR THE PHOTOTRANSISTOR

Beside these tolerances, one also needs to see the typical temperature behavior:

TCUT1300X01, TCPT1300X01

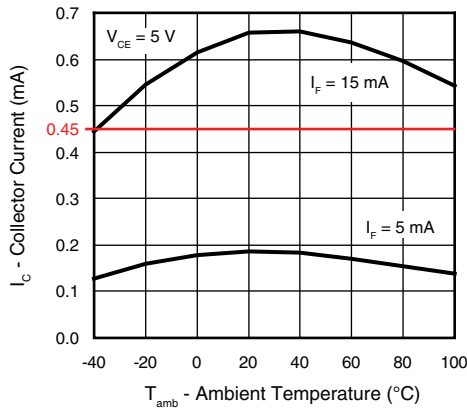

Fig. 3 - Collector Current vs. Ambient Temperature

**TCUT1350X01, TCPT1350X01,
TCUT1600X01, TCPT1600X01**

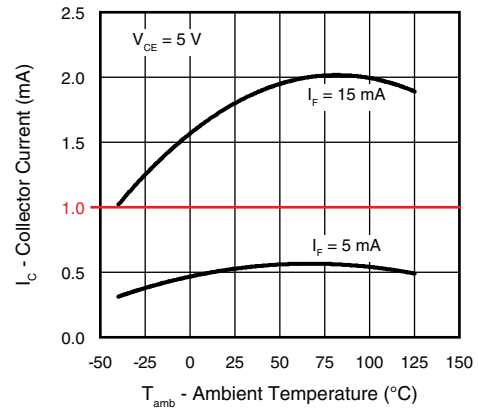

Fig. 4 - Collector Current vs. Ambient Temperature

The TCUT1300X01 and TCPT1300X01 show for -40 °C an I_C of 0.45 mA. 0.65 mA is typical for 25 °C, so this value is about 30 % less. For specified minimum current it would then be just 0.3 mA - 30 % = 0.21 mA.

For the TCUT1350X01, TCPT1350X01, TCUT1600X01, and TCPT1600X01 this is different.

Here for -40 °C an I_C of 1 mA is seen. 1.6 mA is typically seen for 25 °C, so this value is about 40 % less. Calculating here also with minimum specified data, it will lead to 0.7 mA - 40 % = 0.42 mA.

Hardware Description and Design-In Proposals for Single and Dual SMD Transmissive Sensors

DETERMINING THE FORWARD CURRENT FOR THE IRED AND THE LOAD RESISTOR FOR THE PHOTOTRANSISTOR

The degradation of the IRED also needs to be seen. Dealing here with about 5 % will be sufficient for a normal operation profile over the whole lifetime of > 12 years.

A typical circuit will look like the example below. The resistor defining the forward current would then be:
 $R_E = (5\text{ V} - 1.2\text{ V})/15\text{ mA} = 253\ \Omega$. A bit lower normed value will be: $240\ \Omega$.

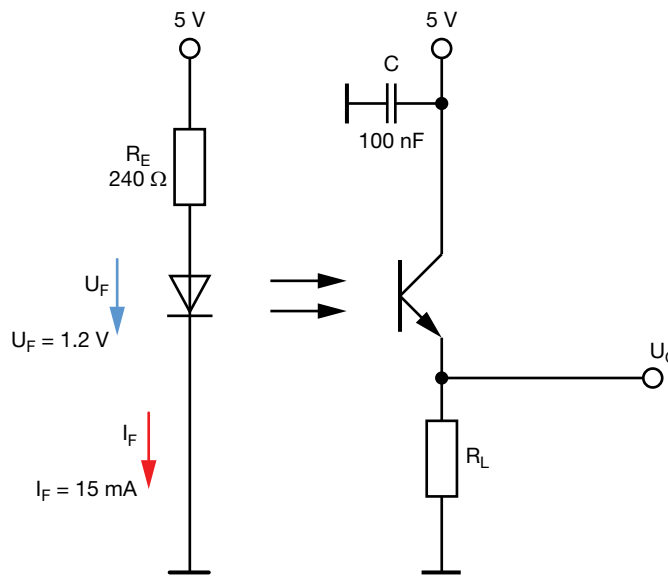

The load resistor value is now dependant on the wanted and needed output voltage. If it needs to deliver a high level to fulfill the input conditions of the following circuitry, e.g. $U_O \geq 4.6\text{ V}$, it would need to be quite high-ohmic.

With having all tolerance in mind, one should just calculate with 0.2 mA (for the TCUT1300X01 and TCPT1300X01) and with 0.46 mA for the TCUT1350X01, TCPT1350X01, TCUT1600X01, and TCPT1600X01.

This leads to a load resistor value of: $4.6\text{ V}/0.2\text{ mA} = 23\text{ k}\Omega$, so, a $R_L \geq 24\text{ k}\Omega$ should be used for the TCUT1300X01 and TCPT1300X01 and $4.6\text{ V}/0.46\text{ mA} = 10\text{ k}\Omega$ for the TCUT1350X01, TCPT1350X01, TCUT1600X01, and TCPT1600X01.

Hardware Description and Design-In Proposals for Single and Dual SMD Transmissive Sensors

TIME-CRITICAL APPLICATIONS

To suppress possible ambient distortions and also improve switching times, it would be wise to choose for the load resistor a value as low as possible.

Output voltage of even less than 1 V will be enough for either a following A/D input or a simple transistor behind.

So, R_L could be about: $R_L = 1 \text{ V} / 0.2 \text{ mA} = 5 \text{ k}\Omega$ (for the TCUT1300X01 and TCPT1300X01) and $R_L = 1 \text{ V} / 0.46 \text{ mA} = 2.2 \text{ k}\Omega$ (for the TCUT1350X01, TCPT1350X01, TCUT1600X01, and TCPT1600X01)

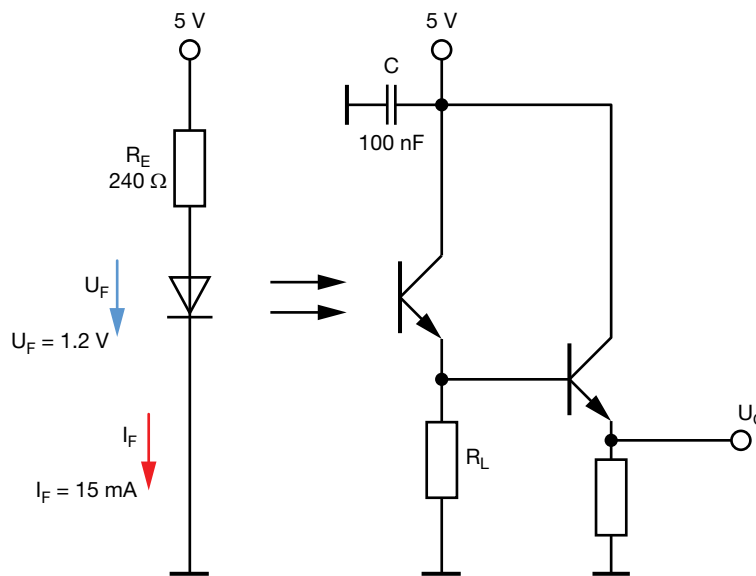

Hardware Description and Design-In Proposals for Single and Dual SMD Transmissive Sensors

TIME-CRITICAL APPLICATIONS

The TCUT1300X01 and TCPT1300X01 show a typical rise / fall time of 20 μ s / 30 μ s:

| SWITCHING CHARACTERISTICS | | | | | | |
|---------------------------|--|--------|------|------|------|---------|
| PARAMETER | TEST CONDITION | SYMBOL | MIN. | TYP. | MAX. | UNIT |
| Rise time | $I_C = 0.3 \text{ mA}$, $V_{CE} = 5 \text{ V}$, $R_L = 100 \Omega$ (see Fig. 6) | t_r | - | 20 | 150 | μ s |
| Fall time | $I_C = 0.3 \text{ mA}$, $V_{CE} = 5 \text{ V}$, $R_L = 100 \Omega$ (see Fig. 6) | t_f | - | 30 | 150 | μ s |

The TCUT1350X01, TCPT1350X01, TCUT1600X01, and TCPT1600X01 are specified with lower timings:

| SWITCHING CHARACTERISTICS | | | | | | |
|---------------------------|--|--------|------|------|------|---------|
| PARAMETER | TEST CONDITION | SYMBOL | MIN. | TYP. | MAX. | UNIT |
| Rise time | $I_C = 0.7 \text{ mA}$, $V_{CE} = 5 \text{ V}$, $R_L = 100 \Omega$ (see Fig. 6) | t_r | - | 9 | 150 | μ s |
| Fall time | $I_C = 0.7 \text{ mA}$, $V_{CE} = 5 \text{ V}$, $R_L = 100 \Omega$ (see Fig. 6) | t_f | - | 16 | 150 | μ s |

For all devices this is valid only with the test circuit shown, typical collector current, and at $T_{amb} = 25 \text{ }^\circ\text{C}$.

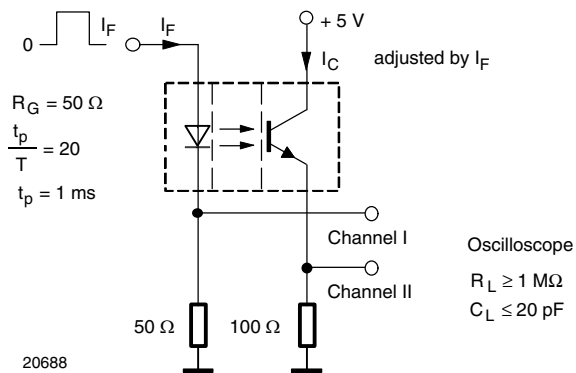

Fig. 5 - Test Circuit for t_r and t_f

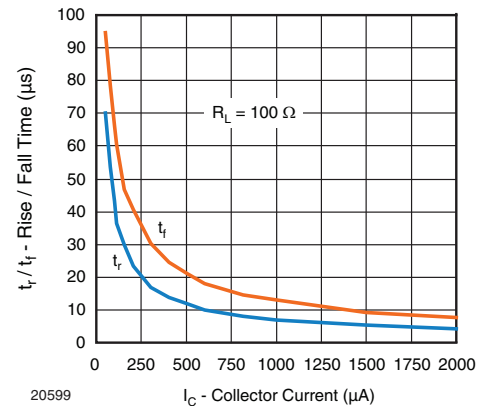

Fig. 6 - Rise / Fall Time vs. Collector Current

For higher load resistors = lower collector current, significantly higher timings will be seen, as also indicated within Fig. 6.

Hardware Description and Design-In Proposals for Single and Dual SMD Transmissive Sensors

TIME-CRITICAL APPLICATIONS

For higher temperatures these timings will also increase. For a quite low load resistor of just 1 kΩ, specified typical values of 20 μs / 30 μs will also at 25 °C show already 27 μs / 43 μs, but for T_{amb} = 80 °C these may be as high as 38 μs (t_r) and 65 μs (t_f).

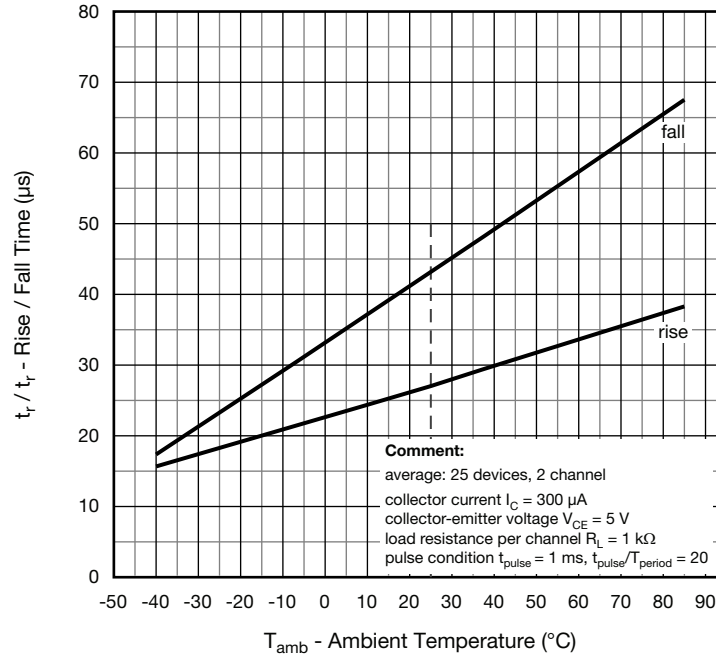

Fig. 7 - Rise / Fall Time vs. Ambient Temperature

With a load resistor of 22 kΩ the “ON” time will not increase that much, but the “OFF” time is ten times higher to about 270 μs, and this is already at T_{amb} = 25 °C. With 47 kΩ, again about a factor of three for fall time will be seen, so, about 800 μs.

For an operation temperature of 85 °C this will increase then to about 1 ms, and for lower collector currents either due to a device coming with a specified minimum value or operating with lower forward current, this may again be doubled.

Hardware Description and Design-In Proposals for Single and Dual SMD Transmissive Sensors

OPERATING WITH LOW FORWARD CURRENTS

Some applications may need to design the circuitry for the lowest-possible current consumption. All IR emitter diodes should work with a defined minimum forward current to deliver stable optical output. For the reflective sensors it should be ≥ 3 mA. For lower emitter currents the typical CTR may also be different and the provided graph (I_C vs. I_F) may show different behavior. So, it is not possible to assume that a parallel line within the I_C vs. I_F graph could show the correct collector current.

TCUT1300X01, TCPT1300X01

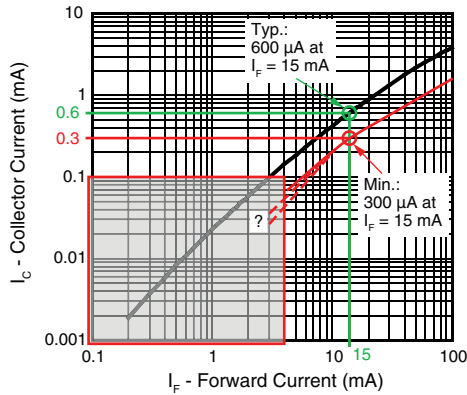

Fig. 8 - Collector Current vs. Forward Current

**TCUT1350X01, TCPT1350X01,
TCUT1600X01, TCPT1600X01**

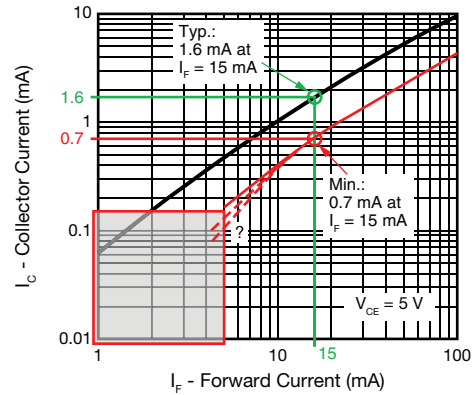

Fig. 9 - Collector Current vs. Forward Current

Hardware Description and Design-In Proposals for Single and Dual SMD Transmissive Sensors

AMBIENT LIGHT DISTURBANCES

The sensors may also be used under critical light conditions. Some daylight or other light sources may be around and could affect the phototransistor, as this is not equipped with any filter. Due to construction requirements it is not possible to have a kind of daylight filter added here.

A wide bandwidth will also allow for possible ambient light distortions.

The spectral bandwidth curve will look similar to the graph below (same phototransistor chip):

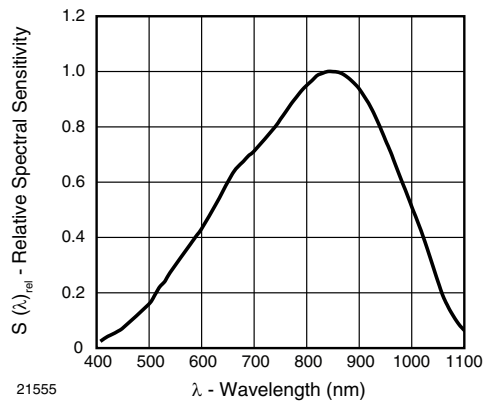

Fig. 10 - Relative Spectral Sensitivity vs. Wavelength

| BASIC CHARACTERISTICS ($T_{amb} = 25\text{ }^{\circ}\text{C}$, unless otherwise specified) | | | | | | |
|---|----------------|-----------------|------|-------------|------|------|
| PARAMETER | TEST CONDITION | SYMBOL | MIN. | TYP. | MAX. | UNIT |
| Wavelength of peak sensitivity | | λ_p | - | 825 | - | nm |
| Range of spectral bandwidth | | $\lambda_{0.1}$ | - | 440 to 1070 | - | nm |

Hardware Description and Design-In Proposals for Single and Dual SMD Transmissive Sensors

AMBIENT LIGHT DISTURBANCES

Light with wavelengths higher than 450 nm will disturb the TCUT1300X01, TCPT1300X01, TCUT1350X01, and TCPT1350X01, according to Fig. 13. Even red LEDs distributing light at about 630 nm. White LEDs show a wide wavelength range - besides a blue peak at about 450 nm - mainly at 520 nm to 630 nm.

Relative spectral sensitivity of the photodetectors used within the TCUT1300X01, TCPT1300X01, TCUT1350X01, and TCPT1350X01 will recognize this with about 10 % to 50 % of its main sensitivity.

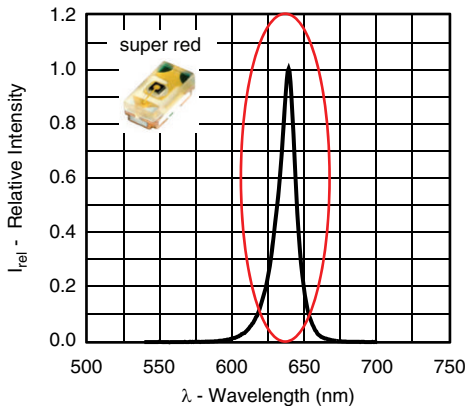

Fig. 11 - Relative Intensity vs. Wavelength (super red)

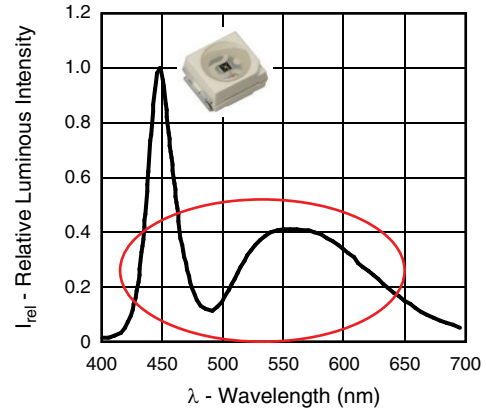

Fig. 12 - Relative Intensity vs. Wavelength

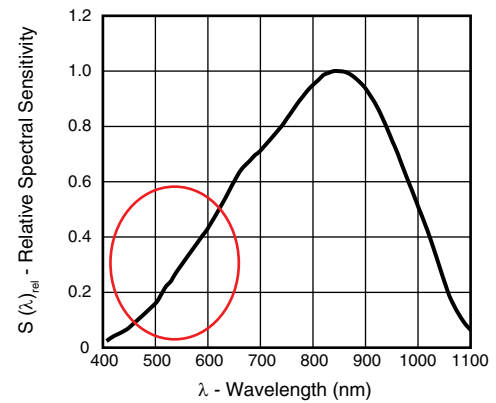
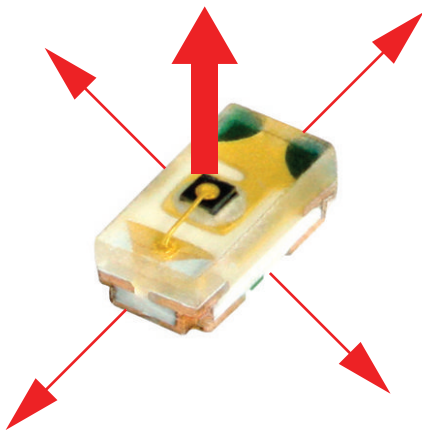

Fig. 13 - Relative Spectral Sensitivity vs. Wavelength

Hardware Description and Design-In Proposals for Single and Dual SMD Transmissive Sensors

AMBIENT LIGHT DISTURBANCES

Very closely positioned red (or even white) LEDs could disturb the TCUT's / TCPT's detector, because all LEDs / IREDS send out light to all sides and there is no filter within the TCUT / TCPT.

Directing the LEDs straight to the TCUT's / TCPT's detector should be avoided.

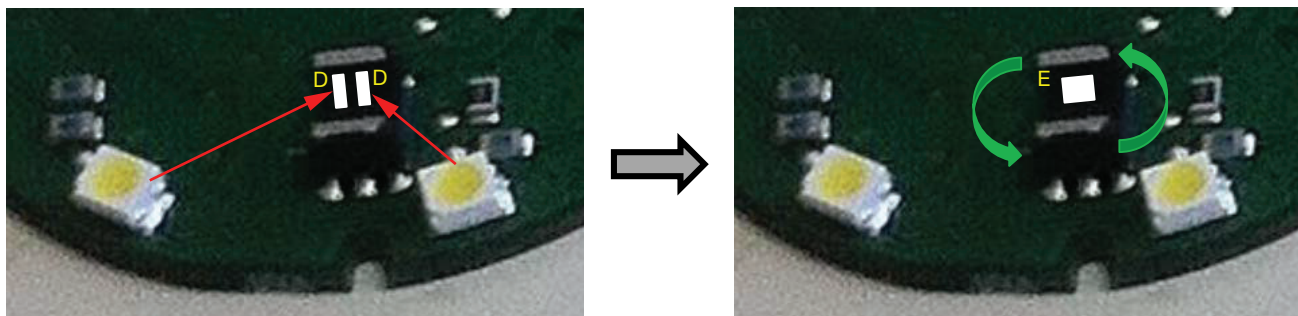

One possible improvement could be to turn the TCUT / TCPT around. That would avoid the possibility that the LEDs reach the photodetector(s) (D) directly.

Too wide slots of the code wheel for the TCUT's / TCPT's detector should be avoided.

An improvement could be with a reduced width of the openings / slots. That would avoid the possibility that the LEDs reach the photodetector(s) (D) directly.

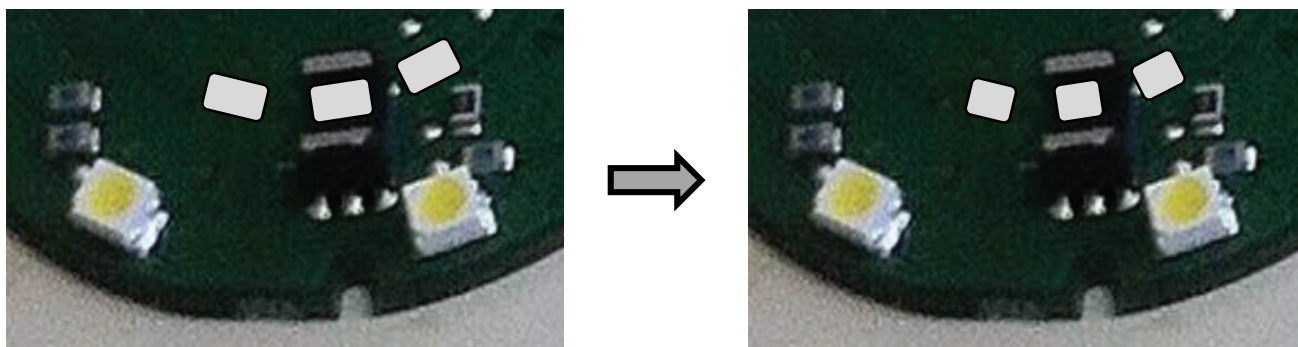

Also, a quite high forward current for the TCUT's / TCPT's emitter and a low load resistor value at the detector side would help to reduce sensitivity to stray light.