



Professionally approved products.

User Manual

FULL HD Vehicle Video Recorder

Article no: 8802208





Index

A. Feature Description	1
B. Specification	2
C. Accessories	2
D. Schematic Diagram of The Installation Steps.....	3
E. Product Function Introduction	5
F. SD Card Installation	6
G. Remote Controller Description	7
H. OSD Menu function	8
I. Recording / Stop Recording	8
J. Viewer Player	9
1. Operation icon introduction	9
2. Capture	9
3. Configuration	10
4. File backup.	12
5. Play back	13
6. Play BAR	13
7. Play speed.....	13
8. Volume control.....	14
9. G-SENSOR.....	14
10. Format: Format memory card/Langue setting.....	14
K. Record Time Estimation	16
L. Appendix: The Indication of Bright and Dark Spot of LCD.....	17



>> About this User Manual

The purpose of this user manual is to provide information about your video black box and may be subject to change, without notice. We have made every effort to ensure that this user manual is as complete and accurate as possible. However, it may contain errors or omissions for which we shall not be liable. RS component reserves the right to change specifications without notice.

>> Introduction

Thank you for choosing this video black box for vehicles. This product is designed to record video and audio in real time leads your vehicle.

You will discover throughout this manual the information necessary for the proper handling of your video black box. However, if it is missing one or more information, please let us know by e-mail:



A. Feature Description

- Full HD Real-time recorder (H.264 compression technology).
- 105° Wide-angle CMOS Lens.
- 2.5" TFT LCD.
- Record video with sound inside and outside the car.
- Compatible with SDHC Card up to 32GB.
- Loop recording / on start recording.
- Emergency recording, file save to separate area to prevent overwritten.
- Built-in G-Sensor, auto recording accident footage.



B. Specification

Items	Description
Sensor	CMOS
View Angle	105° Wide-angle
Resolution	NTSC 30fps / PAL 25fps
V / A	DC5V±5% / 1A
Operating tmp.	-10°C ~ +60°C
Display	2.5" TFT LCD
Storage	4GB SDHC Card or above (Recommend 『SanDisk』 or 『Transcend』 Class 10 or above)
Recording way	On start auto recording, stop recording when power off
Recording content	Date/Time/Image/Sound/G-Sensor data)
Storage Format	Special format, playing on LCD screen with remote control. Or specific Player bundled.
Audio Input	Built-in microphone
Time setting	Built-in permanent calendar with adjustable function through remote control or bundled Player
G-Sensor	Built-in 3D G-Sensor

C. Accessories

■ Standard

- 1 Adapter
- 2 IR remote control
- 3 Software CD
- 4 3M sticker

D. Schematic Diagram of The Installation Steps

1. To install the device on the windshield by "Stick-Holder" Type

Sticker Adhesive Spot

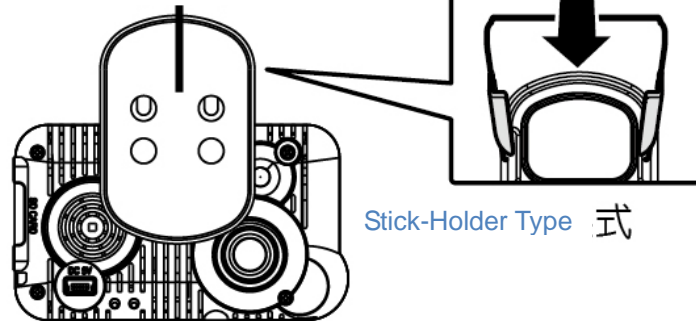

2. The best position to install the device on the windshield

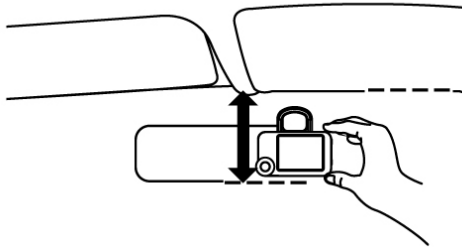

3. To adjust the recording angle properly

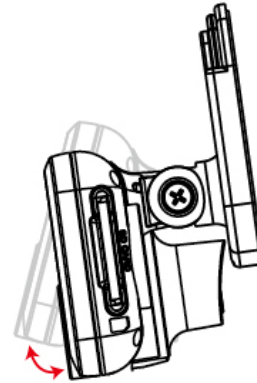

4. Plug in DC5V Power Supply

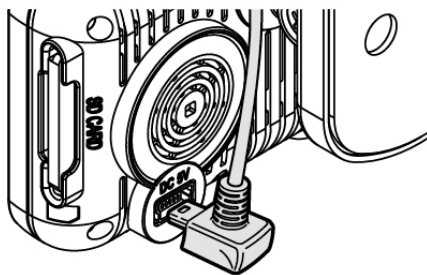

5. Plug in the Cigarette Charger

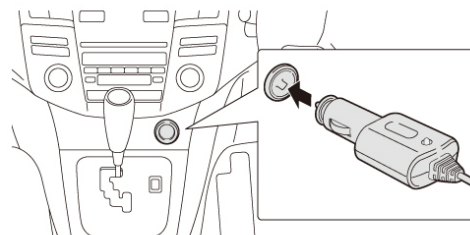

6. VVR installation

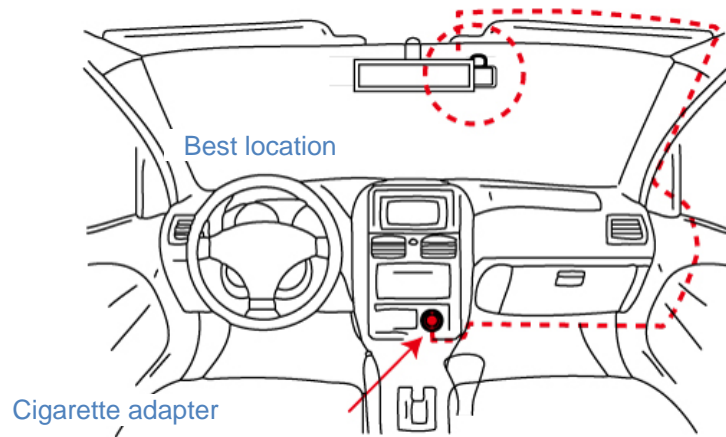

Notice

- (1). This device should be installed in the area where the windshield will be able to be cleaned.
- (2). Formatting SD card on the device before beginning to use.
- (3). Set time zone and timing on OSD.
- (4). NTSC or PAL setting through OSD.

E. Product Function Introduction

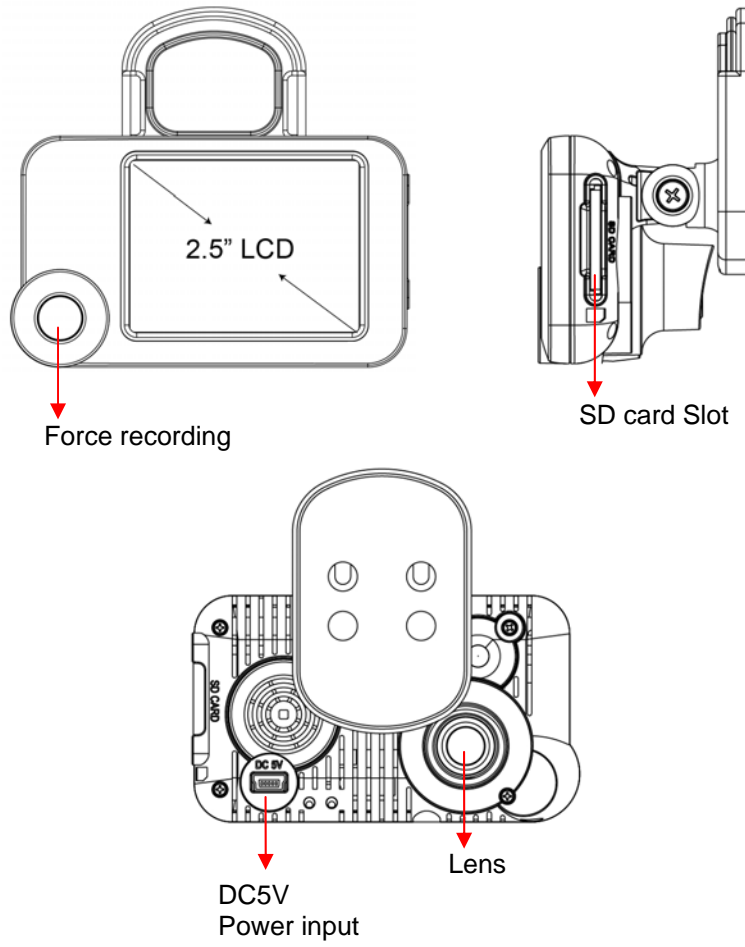

Unit: mm

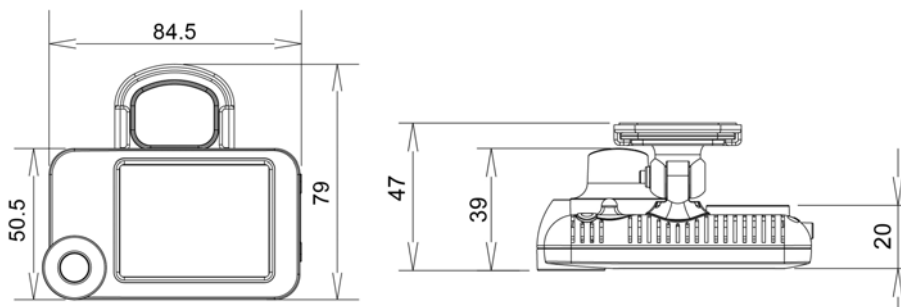

F. SD Card Installation

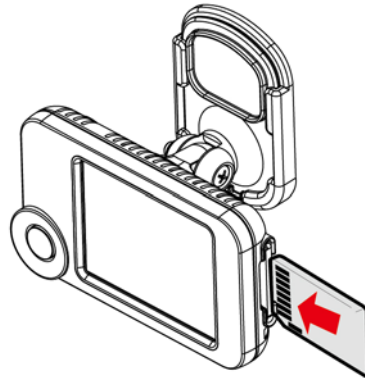

- (1). Format memory card; please refer to the other chapter “Formatting memory card” for more detail.



Warning

- (1). Recommend Memory Card “SanDisk” or “Transcend” Class 10 or above. (Minimum of 4GB)
- (2). If the memory card is not formatted by our exclusive player, the device will automatically erase all the data inside of the memory card after inserting it, start recording at default setting.
- (3). Please don't convert Micro SD to SD card to begin recording, to avoid the damage during recording.
- (4). Since memory cards have the writing endurance situation, we recommend to inspect the memory card and use pc for playback regularly, to ensure that the memory card can read and write



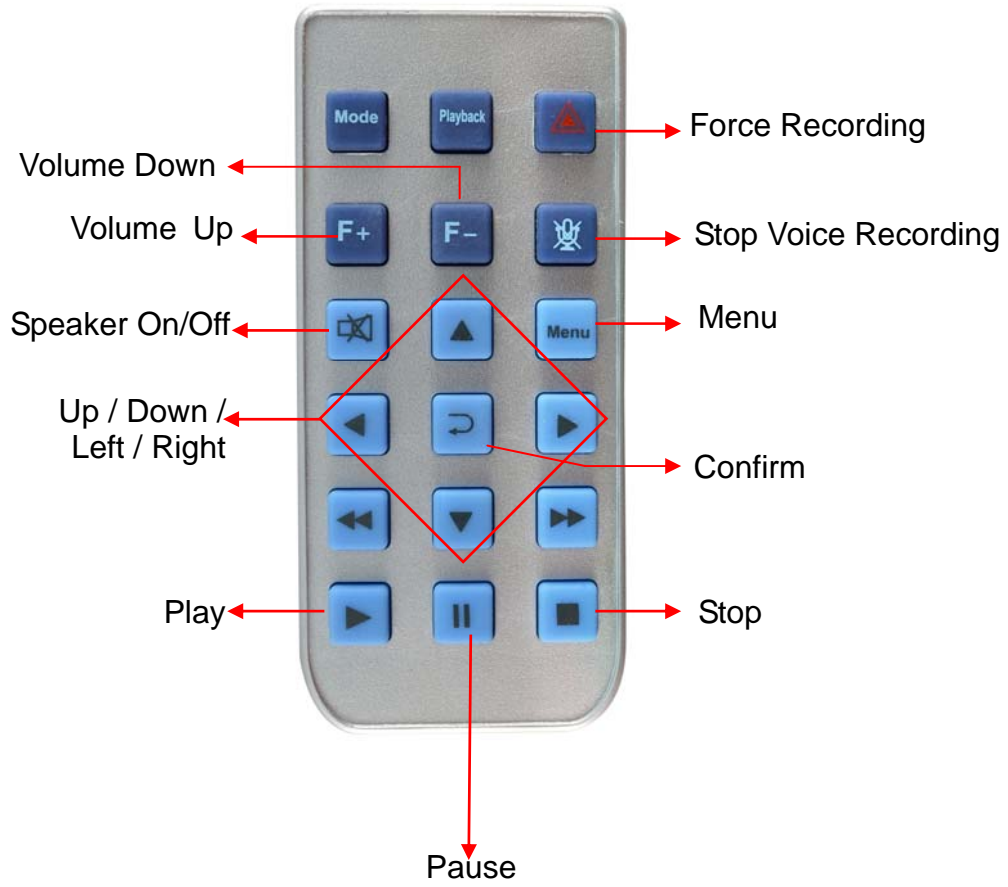

G. Remote Controller Description

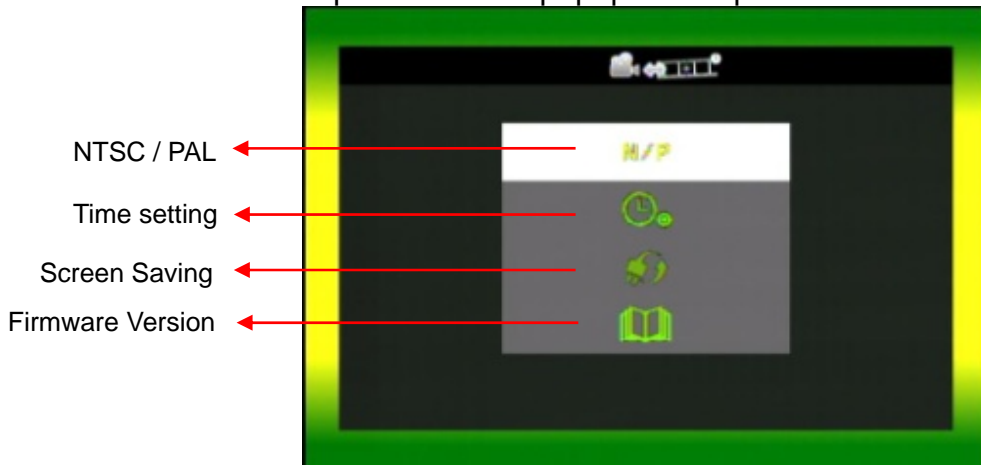

H. OSD Menu function

In Live view screen press  will popup OSD operation menu as follows:



1. Video Type :Click  to choose NTSC /Pal
2. Time setting: Click  to adjust clock
3. Screen Saving: Click  to setup the delay time of screen off.
4. Firmware Version:  Show Firmware Version

I. Recording / Stop Recording

1. Power On/Recording

When car power on, the device start up automatically. Please wait for 30 Sec. to start recording.

2. Power Off/Stop recording

When the car power off, the device will stop to record video and sound. You can take off the memory card and insert to computer to view the video.

3. Indication







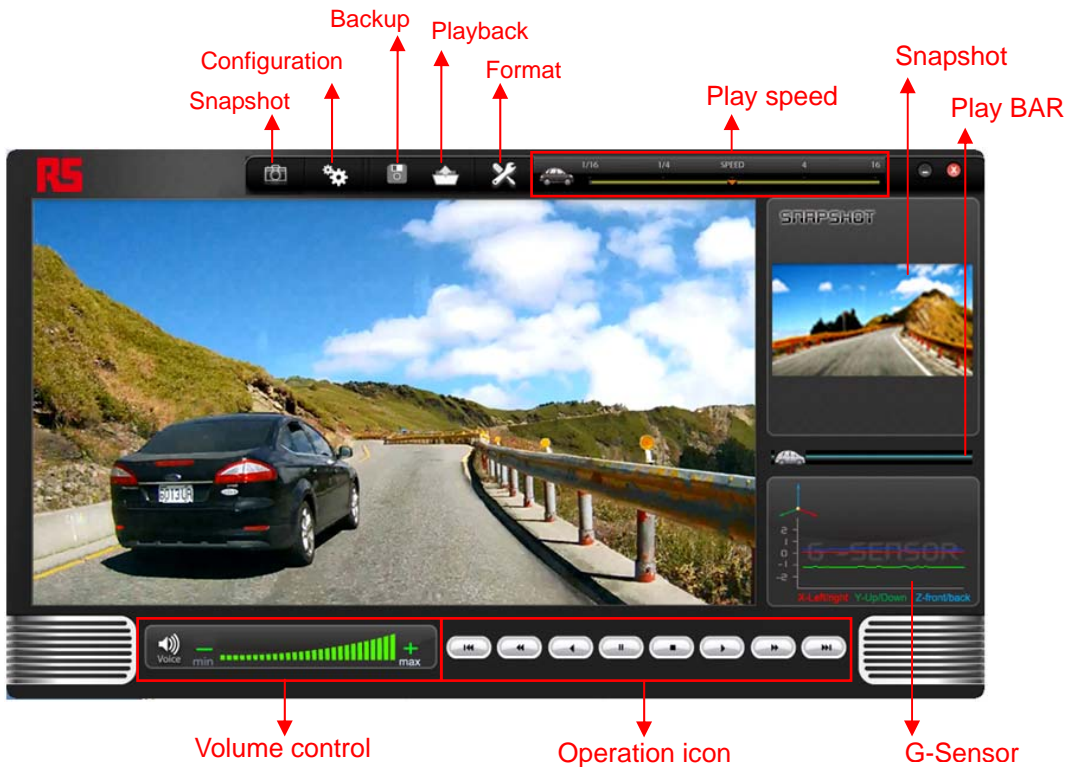

Red light Blinking when recording. (Emergency recording blinking fast)

J. Viewer Player

★This player needs DirectX 9.0 or above installed in your PC.



1. Operation icon introduction

	Back to previous file
	Previous image
	Reward
	Pause
	Stop
	Play
	Next image
	Next footage

2. Capture: Capture the current screen image

You can capture the image when play the footage, click  button the capture the image, The following windows will shows, the image you captured is showing on the right side. File saving cdirectory are in /Snapshot folder, and the file type is *.bmp.

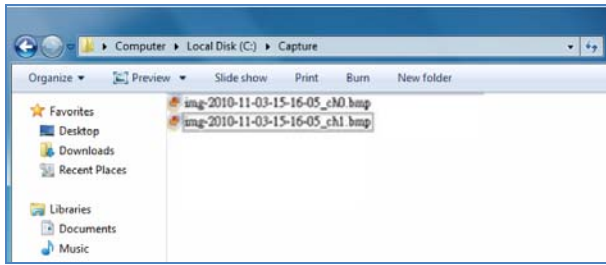

(Capture File)





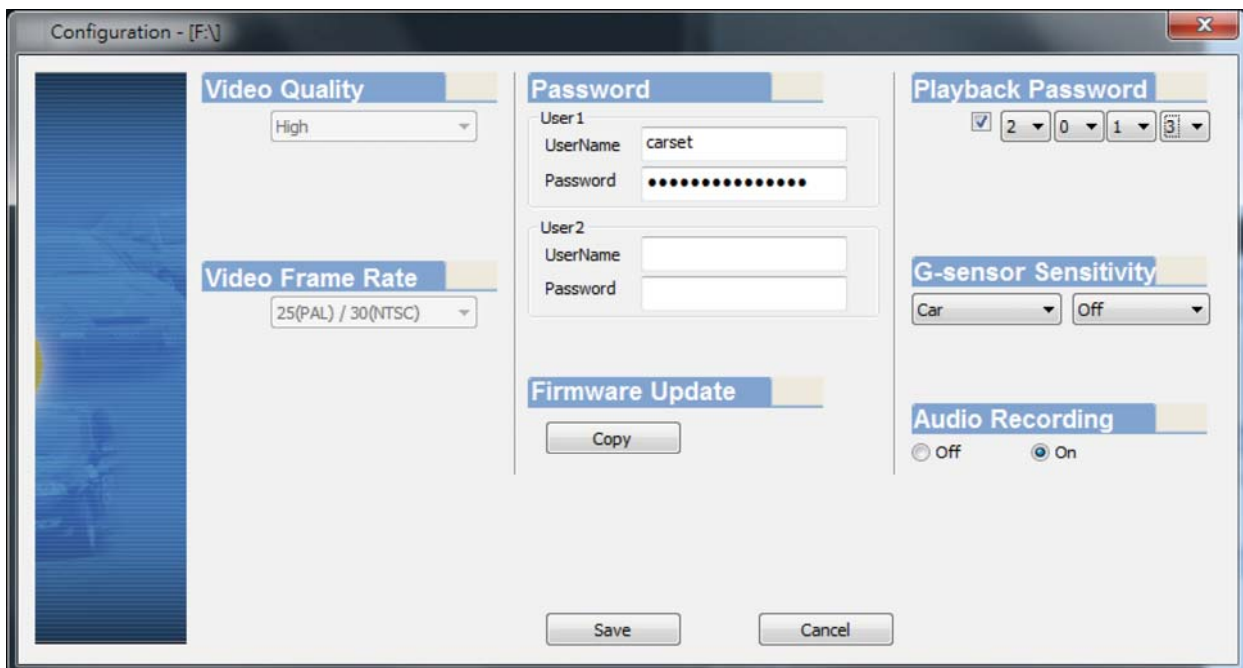

(SNAPSHOT show)

3. Configuration : configure default setting

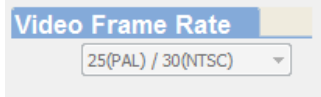
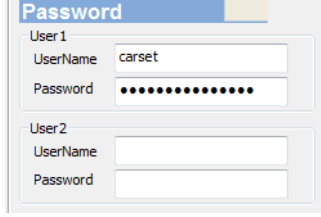
Put the SD Card into Card reader and plug-in the card reader into the USB slot of your PC to format the SD card before the first time to record. Then also need to configure video type and display way, When finish the setting, insert the SD card the vehicle video recorder to start recording.

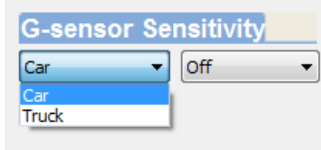
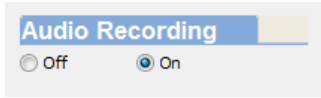

1	Image quality		The default quality is high
2	fps setting		25(PAL) / 30(NTSC)
3	Password		<p>This function can encrypt the SD card to prevent illegal retrieving from others, the password is under 15 character, for example:123456789123456 You will need input password when you playback/configuration/format SD card if you set a password. ★Note: Upper/lower character is different; remember the password is very important.</p>
4	Password in LCD playing		You can setup the password, when playback on the device LCD, you need to unlock the password.
5	G-sensor sensitivity		<p>G-Sensor can detect the impact form vehicle to active emergency recording function automatically. You can set the sensitivity here. There are car、truck to choose. The sensitivity has 5 options to choose: Off / Very low / Low / Normal / High/ Very high.</p>
6	Sound recording		Switch on/off the sound recording.

4.  File backup: click to choose file save directory.

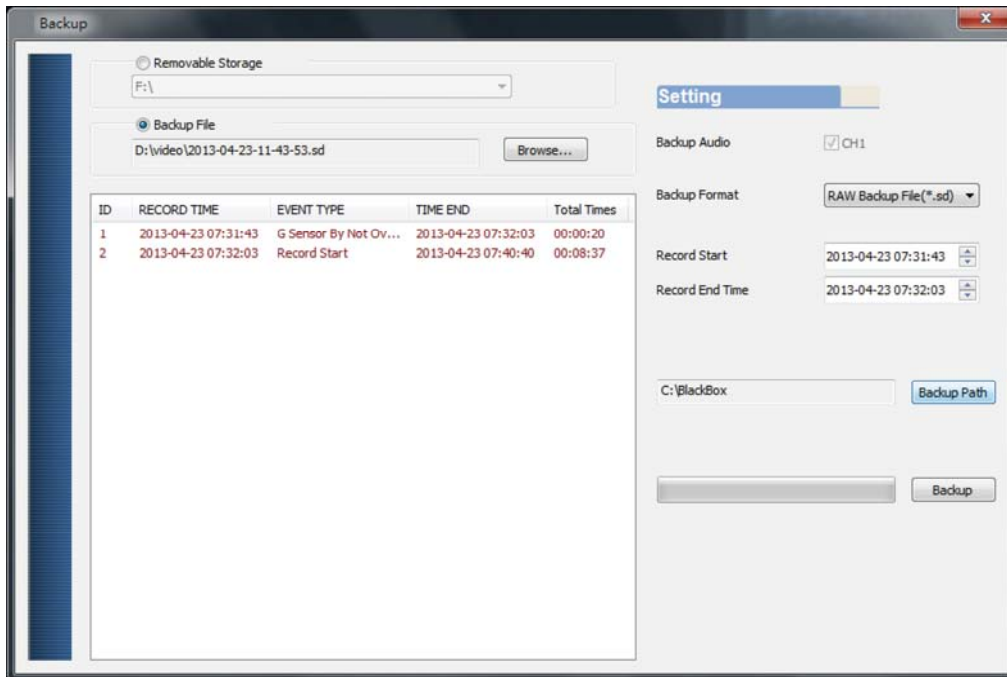

Step1. Choose the source of the memory card.

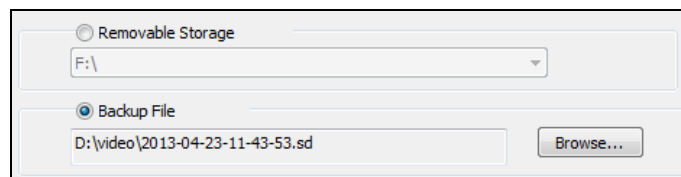

Step2. Choose the footage you want to backup.

ID	RECORD TIME	EVENT TYPE	TIME END	Total Times
1	2013-04-23 07:31:43	G Sensor By Not Ov...	2013-04-23 07:32:03	00:00:20
2	2013-04-23 07:32:03	Record Start	2013-04-23 07:40:40	00:08:37

Step3. Choose the target file format and start and end record time.

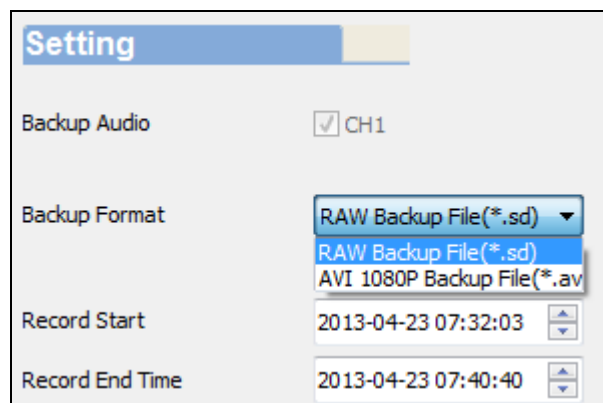

File format

- (1) Our original file format

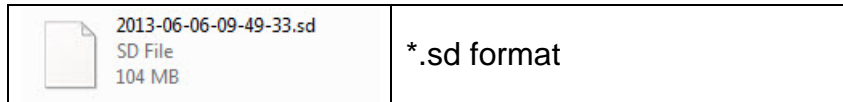

(2)AVI File Backup(*.avi)

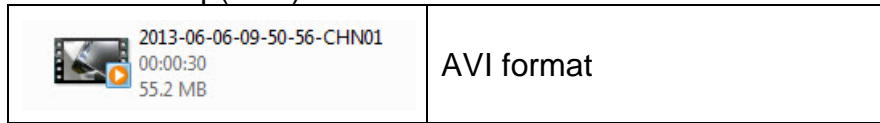

★Note: If you backup with our original format, you can keep the G-SENSOR data, if you backup by AVI format, you will lost G-sensor data (only date/time/image/sound to be save)

Step 4. Set the backup folder: default is C:\BlackBox

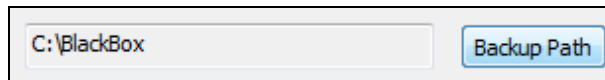

Step 5. Start to backup

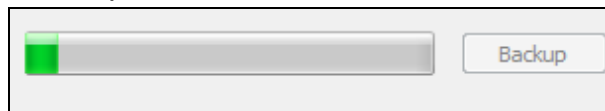

5. Play back: Open file

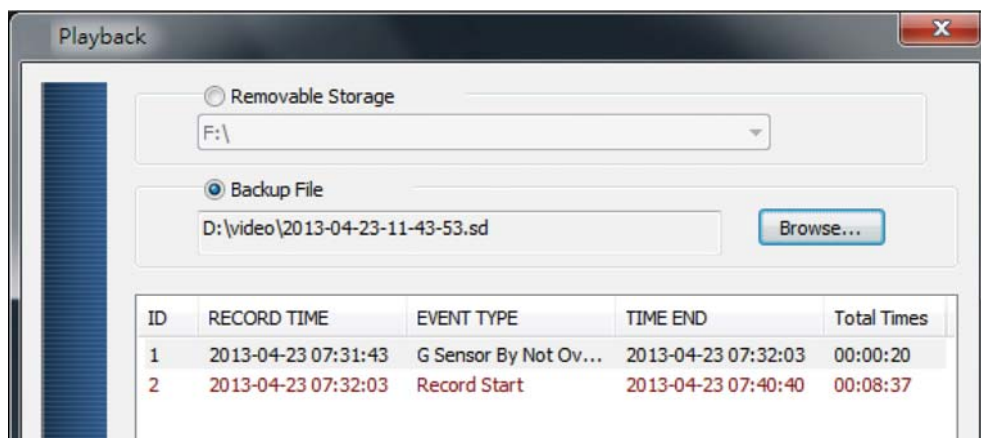

6. Play BAR: You can use Mouse to drag the car icon to move footage location

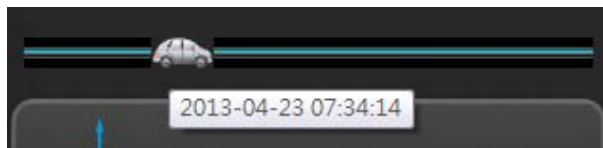

7. Play speed: 2X、4X、8X、16X and quick playback, 1/2X、1/4X、1/8X、1/16X and slow playback.



8. Volume control: Click +, - to adjust volume.



9. G-SENSOR

G-Sensor will detect the impact form the car, and record 1-3 minutes footage automatically. This footage will save to separate area to avoid file overwritten.



- (1) **X**: Detect vehicle horizontal change.
- (2) **Y**: Detect vehicle vertical change.
- (3) **Z**: Detect vehicle front/back change.

10.  Format: Format memory card/Langue setting

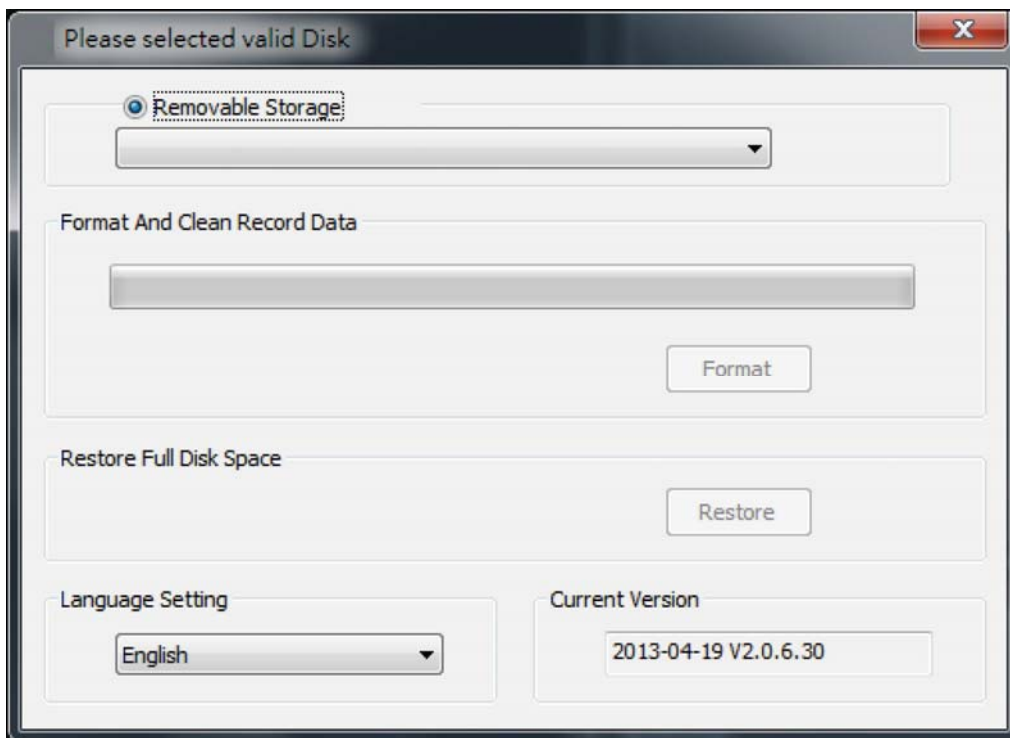



Warning

- (1). 「Format / Restore」 will clean all the data saved on SD card, Please back up the data before 「Format / Restore」 .
- (2). Before 「Format / Restore」 SD memory card, please ensure to unlock it first.
- (3). If the card is unlocked but still cannot be formatted, this might be caused by Window Vista / 7 security restrictions. Please run the program as Administrator to prevent from this problem.

a. 「Format」 SD card

When you use the SD card for the very first time or a brand new card, you should format it in order to use it correctly.

b. 「Restore」 SD card

When you have backup the recorded files into PC and want to use the SDHC card for other purposes, you have to restore it first so it can be used correctly.

c. Language setting

You can change the display language by yourself.

* Note: Change language will effect after rebooting.

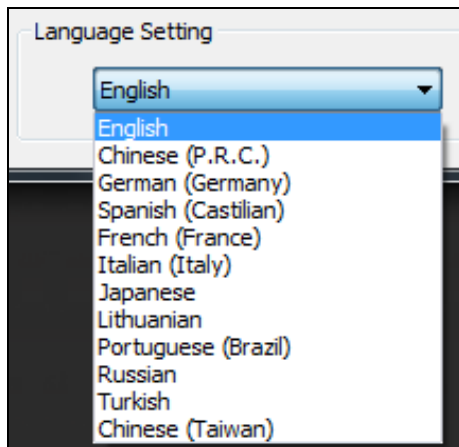

d. Current Version

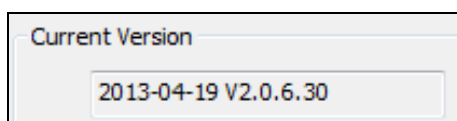



K. Record Time Estimation

The chart of estimated record time listed below is for reference only. The length of time recorded can be varied due to variation in image size may be somewhat different.

Capacity	8G	16G	32G
Video Quality			
High	120 Min	240 Min	480 Min

L. Appendix: The Indication of Bright and Dark Spot of LCD

Q: What is Bright/Dark Spot?

- A :
- Bright Spot: At dark background, we found the abnormal bright spots, we called those spot are “Bright Spot”
 - Dark Spot: At multiple color background (excluded dark background), we found the abnormal dark spot, we called those spot are “Dark Spot”

Q: The indication of Bright and Dark Spot

- (a) There is no bright spot allowed in Area A, only single dark spot or none is allowed.
- (b) The maximum amount of bright spots and dark spots allowed in Area B are two of each.
- (c) The max total amount of bright and dark spots in Area A and B are three or under

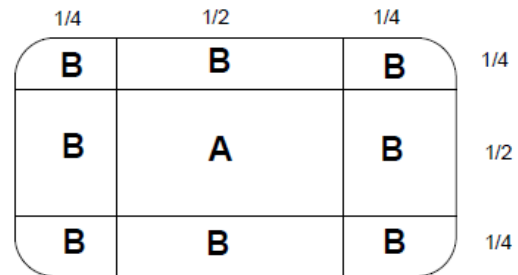

The Diagram of Area A and B



Notcie

- (1). There is 30 days exchanges refer to the indication of bright and dark.
- (2). Please keep the receipt and contact your local dealer for exchanging merchandise.
- (3). The maximum valid date is 30 days.