

# PT481FE0000F

Opaque Resin, Narrow Directivity Angle,  
Darlington Phototransistor



## ■ Features

1. Side view detection package with long terminal
2. Plastic mold with opaque resin lens
3. Peak sensitivity wavelength: 860 nm (TYP.)
4. High sensitivity ( $I_C$ : 10.0 mA TYP.)
5. Narrow acceptance angle ( $\Delta\theta \pm 13^\circ$  TYP.)
6. Lead free and RoHS directive compliant

## ■ Agency Approvals/Compliance

1. Compliant with RoHS directive (2002/95/EC)
2. Content information about the six substances specified in "Management Methods for Control of Pollution Caused by Electronic Information Products Regulation" (popular name: China RoHS) (Chinese: 电子信息产品污染控制管理办法); refer to page 7.

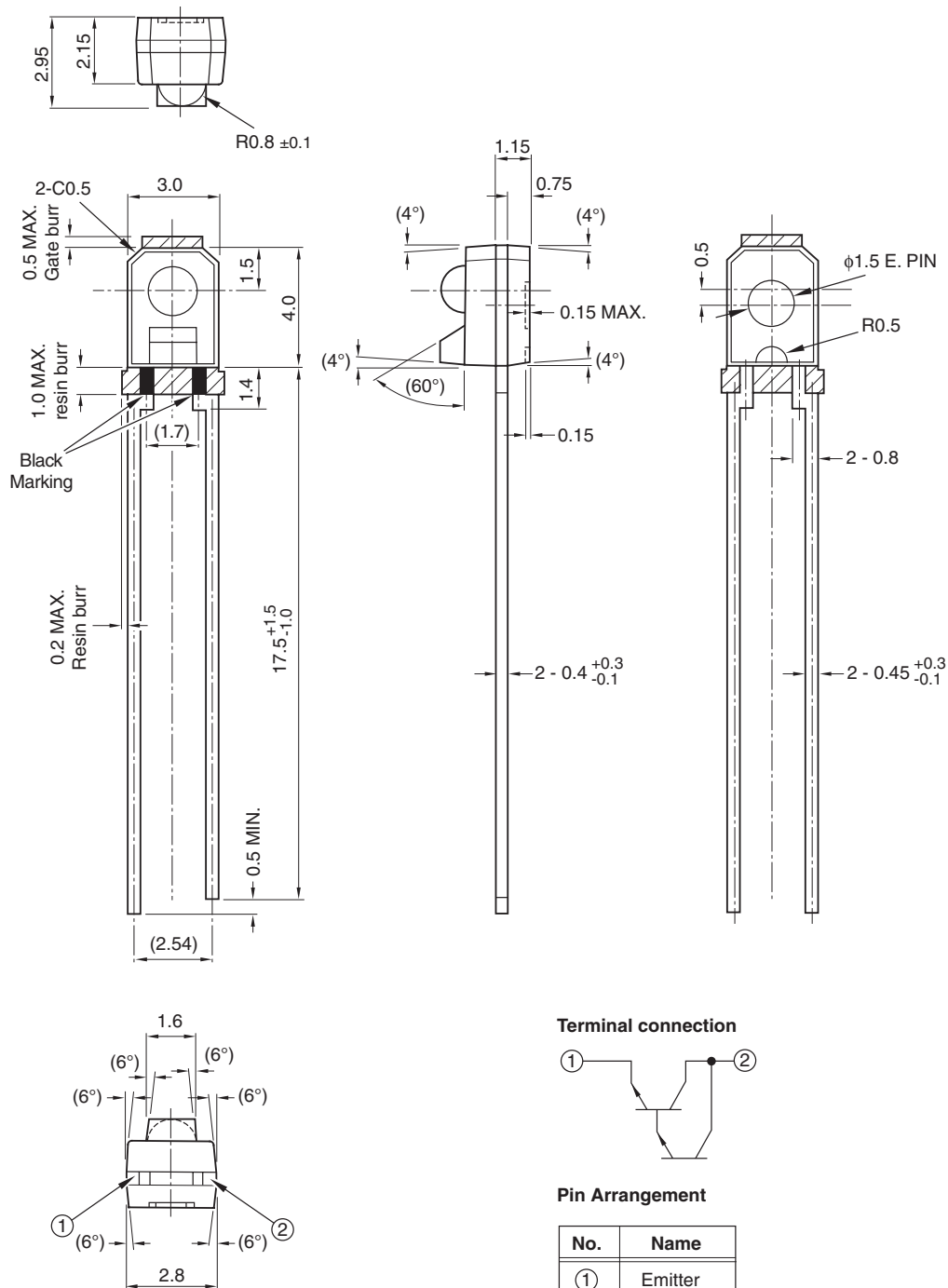
## ■ Applications

1. Optoelectronic switches
2. Automatic stroboscopes
3. Mechanical Systems
4. Office automation equipment
5. Audio visual equipment

Notice The content of data sheet is subject to change without prior notice.

In the absence of confirmation by device specification sheets, SHARP takes no responsibility for any defects that may occur in equipment using any SHARP devices shown in catalogs, data books, etc. Contact SHARP in order to obtain the latest device specification sheets before using any SHARP device.

**External Dimensions**



**NOTES:**

1. Units: mm
2. Unspecified tolerance: ±0.2 mm
3. ( ): Reference dimensions
4. Package: Visible light cut-off epoxy resin (black)
5. Mold burrs (0.05 mm MAX.) are not included in outline dimensions
6. Resin protrusion: 1.0 mm MAX.
7. Lead step is 1.4 mm MAX. from the part's resin

**■ Absolute Maximum Ratings** (Ta = 25°C)

Parameter	Symbol	Rating	Unit
Collector-emitter voltage	V <sub>CEO</sub>	35	V
Emitter-collector voltage	V <sub>ECO</sub>	6	V
Collector current	I <sub>C</sub>	50	mA
Collector power dissipation	P <sub>C</sub>	75	mW
Operating temperature	T <sub>opr</sub>	-25 to +85	°C
Storage temperature	T <sub>stg</sub>	-40 to +85	°C
Soldering temperature *1	T <sub>sol</sub>	260	°C

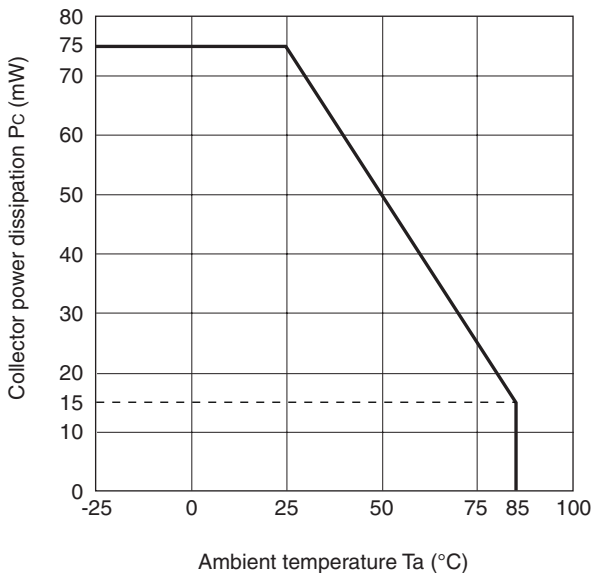
\*1 5 s (MAX.) no closer than 1.4 mm from resin edge.

**■ Electro-optical Characteristics** (Ta = 25°C)

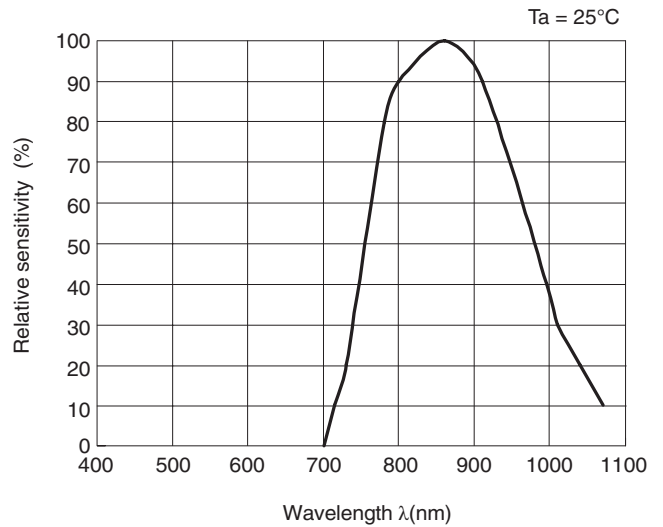
Parameter	Symbol	Conditions *1	MIN.	TYP.	MAX.	Unit
Collector current	I <sub>C</sub>	Ee = 0.1 mW/cm <sup>2</sup> , V <sub>CE</sub> = 2 V	0.9	–	27	mA
Dark current	I <sub>CEO</sub>	Ee = 0, V <sub>CE</sub> = 10 V	–	1.0	1000	nA
Collector-emitter saturation voltage	V <sub>CE(sat)</sub>	Ee = 1 mW/cm <sup>2</sup> , I <sub>C</sub> = 1.5 mA	–	0.7	1.0	V
Collector-emitter breakdown voltage	BV <sub>CEO</sub>	I <sub>C</sub> = 0.1 mA, Ee = 0	35	–	–	V
Emitter-collector breakdown voltage	BV <sub>ECO</sub>	I <sub>E</sub> = 0.01 mA, Ee = 0	6	–	–	V
Peak sensitivity wavelength	λ <sub>p</sub>	–	–	860	–	nm
Response time (Rise)	tr	V <sub>CE</sub> = 2 V, I <sub>C</sub> = 10 mA, R <sub>L</sub> = 100 Ω	–	80	–	μs
Response time (Fall)	tf		–	70	–	μs

\*1 Ee: Irradiance by CIE standard light source A (tungsten lamp)

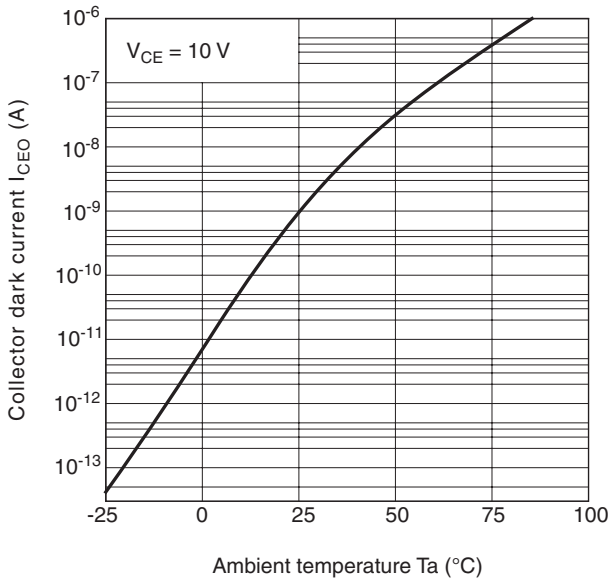
**Fig. 1 Collector Power Dissipation vs. Ambient Temperature**



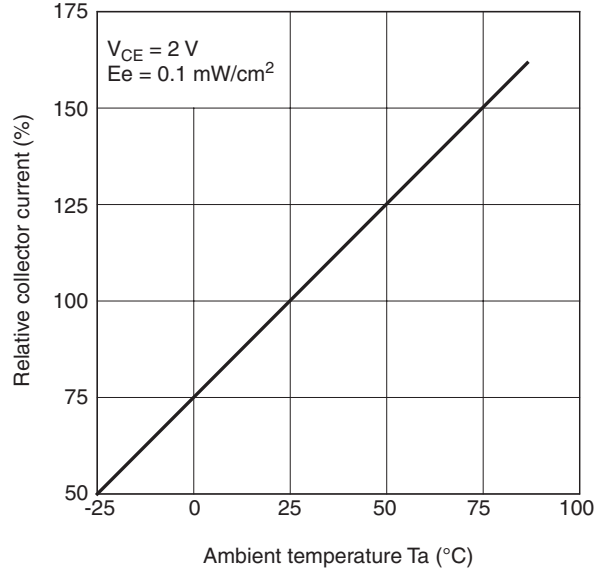
**Fig. 2 Spectral Sensitivity (TYP.)**



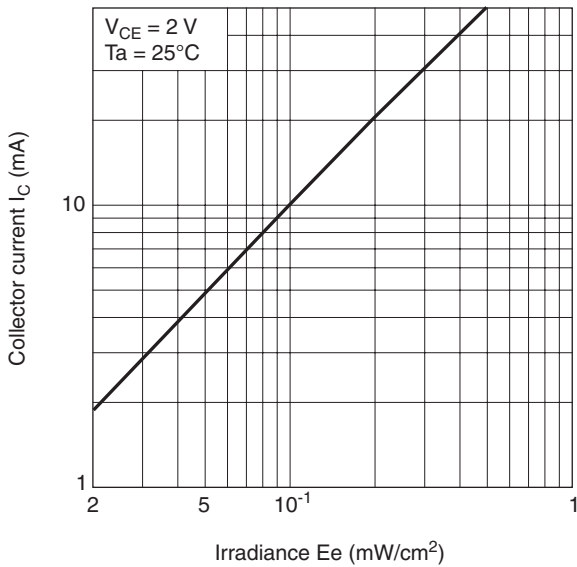
**Fig. 3 Collector Dark Current vs. Ambient Temperature**



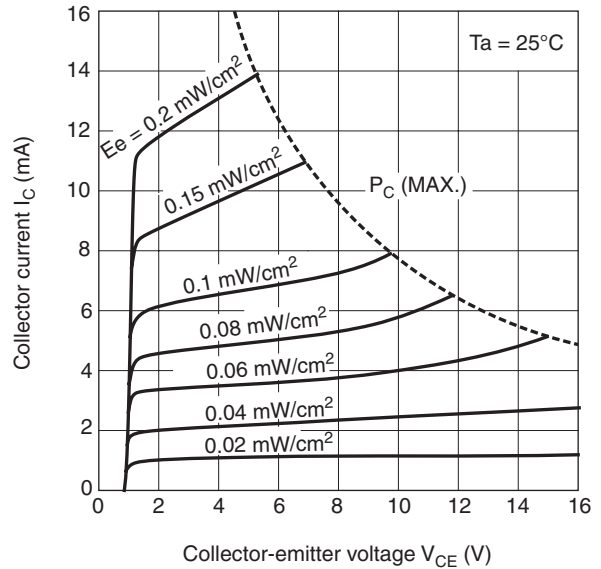
**Fig. 5 Relative Collector Current vs. Ambient Temperature**



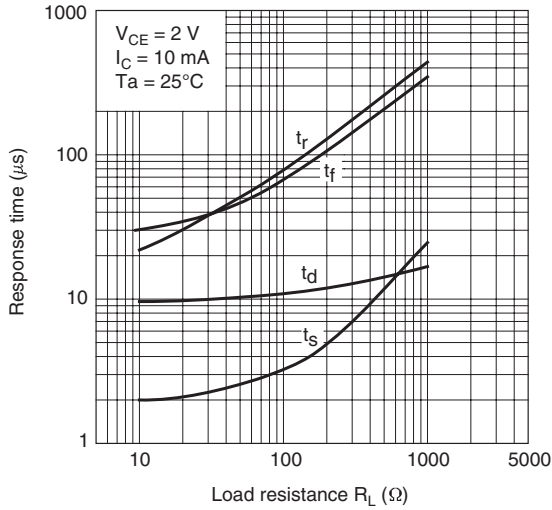
**Fig. 4 Collector Current vs. Irradiance**



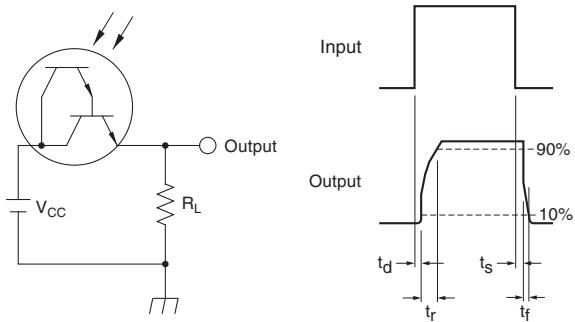
**Fig. 6 Collector Current vs. Collector-Emitter Voltage**



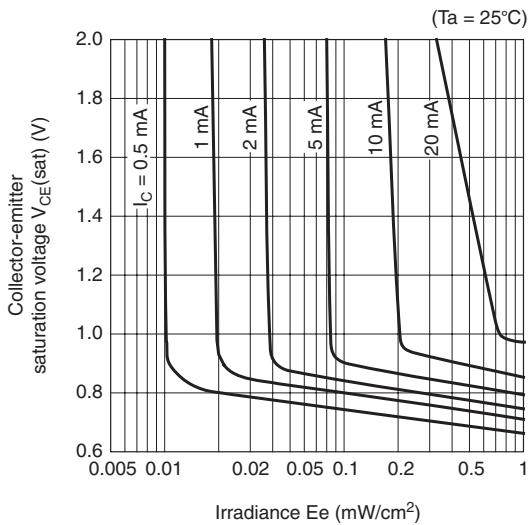
**Fig. 7 Response Time vs. Load Resistance**



**Fig. 8 Test Circuit for Response Time**

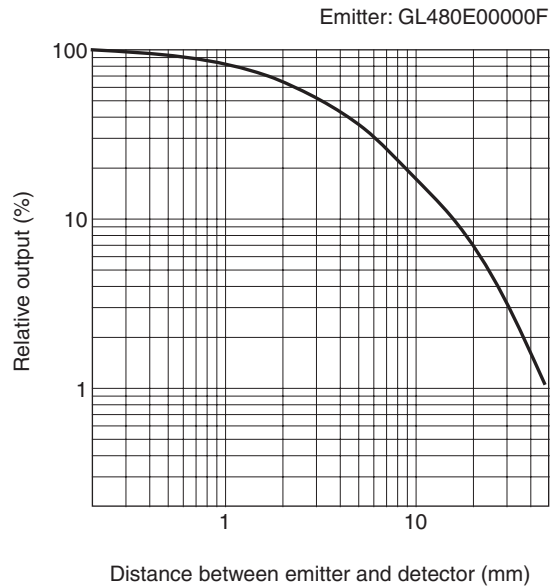


**Fig. 9 Collector-to-Emitter Saturation Voltage vs. Irradiance**

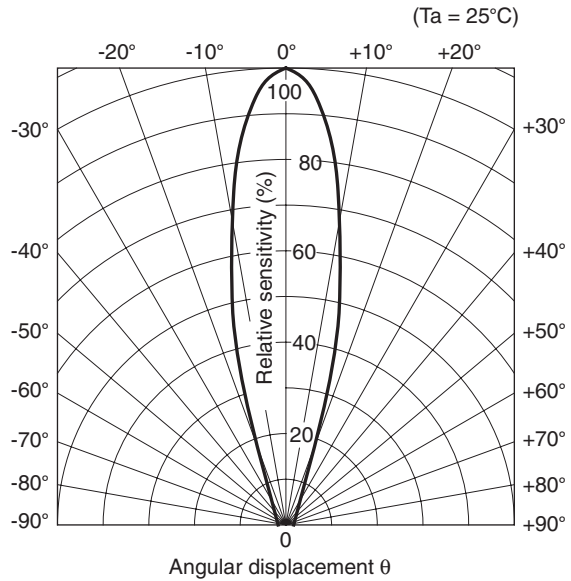


Graph data is for reference only and is not guaranteed data.

**Fig. 10 Relative Output vs Distance**



**Fig. 11 Sensitivity vs. Axis (TYP.)**



## ■ Design Notes

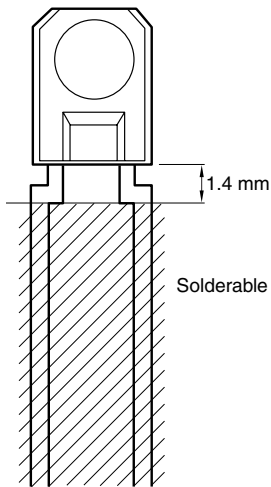
1. This product is not designed to resist electromagnetic and ionized-particle radiation.

## ■ Manufacturing Guidelines

### ● Soldering Instructions

1. Sharp does not recommend soldering this part using preheat or solder reflow methods. Leads on this part are pre-coated with lead-free solder.
2. If hand soldering, use temperatures  $\leq 260^{\circ}$  for  $\leq 5$  seconds.
3. When mounting this device, care should be taken to prevent any boundary exfoliation (pad lifting) between the solder, the pad, and the circuit board.
4. Do not subject the package to excessive mechanical force during soldering as it may cause deformation or defects in plated connections. Internal connections may be severed due to mechanical force placed on the package due to the PCB flexing during the soldering process.

**Fig. 12 Soldering Area**



### ● Cleaning Instructions

1. Confirm this device's resistance to process chemicals before use, as certain process chemicals may affect the optical characteristics.
2. Solvent cleaning: Solvent temperature should be  $45^{\circ}\text{C}$  or below. Immersion time should be 3 minutes or less.
3. Ultrasonic cleaning: The effect upon devices varies due to cleaning bath size, ultrasonic power output, cleaning time, PCB size and device mounting circumstances. Sharp recommends testing using actual production conditions to confirm the harmlessness of the ultrasonic cleaning methods.
4. Recommended solvent materials: Ethyl alcohol, Methyl alcohol, and Isopropyl alcohol.

**■ Presence of ODCs (RoHS Compliance)**

This product shall not contain the following materials, and they are not used in the production process for this product:

- Regulated substances: CFCs, Halon, Carbon tetrachloride, 1,1,1-Trichloroethane (Methylchloroform). Specific brominated flame retardants such as the PBBOs and PBBs are not used in this product at all.

This product shall not contain the following materials banned in the RoHS Directive (2002/95/EC).

- Lead, Mercury, Cadmium, Hexavalent chromium, Polybrominated biphenyls (PBB), Polybrominated diphenyl ethers (PBDE).
- Content information about the six substances specified in “Management Methods for Control of Pollution Caused by Electronic Information Products Regulation” (Chinese: 电子信息产品污染控制管理办法)

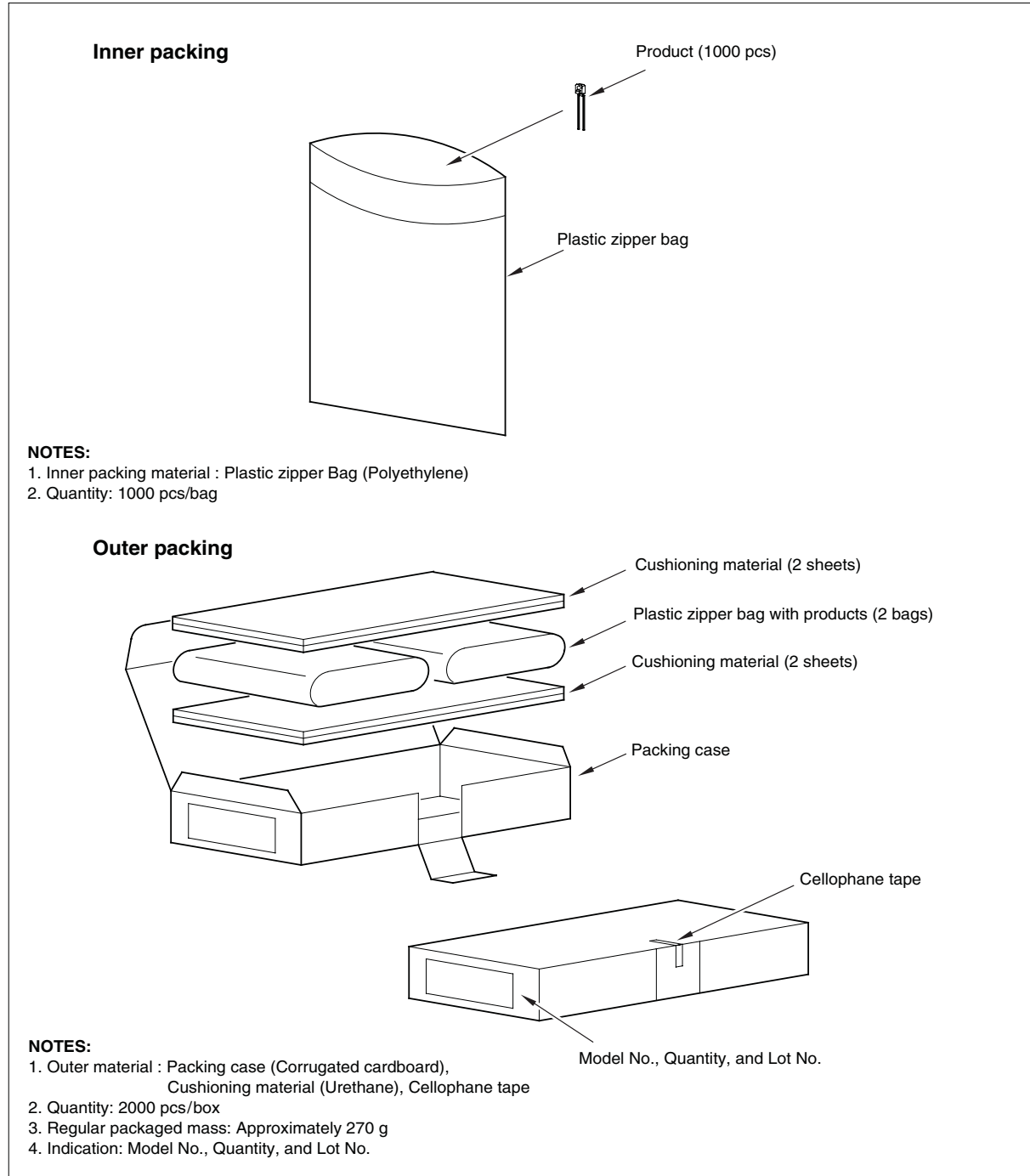
Category	Toxic and Hazardous Substances					
	Lead (Pb)	mercury (Hg)	Cadmium (Cd)	Hexavalent chromiun (Cr <sup>6+</sup> )	Polybrominated biphenyls (PBB)	Polybrominated diphenyl ethers (PBDE)
Photo Transistor	✓	✓	✓	✓	✓	✓

NOTE: ✓ indicates that the content of the toxic and hazardous substance in all the homogeneous materials of the part is below the concentration limit requirement as described in SJ/T 11363-2006 standard.

**■ Packing Specifications**

1. Parts are packed in a plastic zipper bag, with a quantity of 1000 pieces per bag.
2. Bags are secured in a box as shown in Figure 13.
3. Product mass: 0.09 g (approximately)

**Fig. 13 Packing Composition**





## ■ Important Notices

· The circuit application examples in this publication are provided to explain representative applications of SHARP devices and are not intended to guarantee any circuit design or license any intellectual property rights. SHARP takes no responsibility for any problems related to any intellectual property right of a third party resulting from the use of SHARP's devices.

· Contact SHARP in order to obtain the latest device specification sheets before using any SHARP device. SHARP reserves the right to make changes in the specifications, characteristics, data materials, structure, and other contents described herein at any time without notice in order to improve design or reliability. Manufacturing locations are also subject to change without notice.

· Observe the following points when using any devices in this publication. SHARP takes no responsibility for damage caused by improper use of the devices which does not meet the conditions and absolute maximum ratings to be used specified in the relevant specification sheet nor meet the following conditions:

(i) The devices in this publication are designed for use in general electronic equipment designs such as:

- Personal computers
- Office automation equipment
- Telecommunication equipment (terminal)
- Test and measurement equipment
- Industrial control
- Audio visual equipment
- Consumer electronics

(ii) Measures such as fail-safe function and redundant design should be taken to ensure reliability and safety when SHARP devices are used for or in connection with equipment that requires higher reliability such as:

- Transportation control and safety equipment (i.e., aircraft, trains, automobiles, etc.)
- Traffic signals
- Gas leakage sensor breakers
- Alarm equipment
- Various safety devices, etc.

(iii) SHARP devices shall not be used for or in connection with equipment that requires an extremely high level of reliability and safety such as:

- Space applications
- Telecommunication equipment (trunk lines)
- Nuclear power control equipment
- Medical and other life support equipment (e.g. scuba)

· If the SHARP devices listed in this publication fall within the scope of strategic products described in the Foreign Exchange and Foreign Trade Law of Japan, it is necessary to obtain approval to export such SHARP devices.

· This publication is the proprietary product of SHARP and is copyrighted, with all rights reserved. Under the copyright laws, no part of this publication may be reproduced or transmitted in any form or by any means, electronic or mechanical, for any purpose, in whole or in part, without the express written permission of SHARP. Express written permission is also required before any use of this publication may be made by a third party.

· Contact and consult with a SHARP representative if there are any questions about the contents of this publication.