



PCN (Product Change Notice)																																				
<input type="checkbox"/> Major Change <input checked="" type="checkbox"/> Minor Change																																				
PCN Number: PCN_ConPSHD_20250719 Affected Series: WR-PSHD Affected Part Number: see table below PCN Date: 2025-04-19 (YYYY-MM-DD) Effective Date: 2025-07-19 (YYYY-MM-DD)	Change Category: <input type="checkbox"/> Equipment/Location <input checked="" type="checkbox"/> General Data <input type="checkbox"/> Material <input type="checkbox"/> Process <input type="checkbox"/> Product Design <input type="checkbox"/> Shipping/Packaging <input type="checkbox"/> Supplier <input type="checkbox"/> Software																																			
Contact: Product Management Phone: +49 (0) 7942 - 945 5001 Fax: +49 (0) 7942 - 945 5179 E-Mail: pcn.eican@we-online.com	Datasheet Change: <input checked="" type="checkbox"/> Yes <input type="checkbox"/> No Attachment: <input type="checkbox"/> Yes <input checked="" type="checkbox"/> No																																			
DESCRIPTION OF CHANGE: <p>Because of a database mismatch, Würth Elektronik eiSos will correct the tolerances of the product dimensions & recommended land pattern.</p> <p>This is a datasheet correction only. There will be no change in form, fit, function, quality or reliability of the product. The preliminary datasheets of the affected part numbers will be available on the website after the PCN date. Link to the website: WR-PSHD</p> <p>The new revision of the affected part numbers will be sent out after the previous revision is out of stock (according to FIFO - first-in, first-out).</p> <p>Affected part numbers:</p> <table border="1" style="width: 100%; border-collapse: collapse; text-align: center;"> <tbody> <tr><td>61000421121</td><td>61000621121</td><td>61000821121</td><td>61001021121</td><td>61001221121</td></tr> <tr><td>61001421121</td><td>61001621121</td><td>61001821121</td><td>61002021121</td><td>61002221121</td></tr> <tr><td>61002421121</td><td>61002621121</td><td>61003021121</td><td>61003221121</td><td>61003421121</td></tr> <tr><td>61003621121</td><td>61004021121</td><td>61030421121</td><td>61030621121</td><td>61030821121</td></tr> <tr><td>61031021121</td><td>61031221121</td><td>61031421121</td><td>61031621121</td><td>61031821121</td></tr> <tr><td>61032021121</td><td>61032221121</td><td>61032421121</td><td>61032621121</td><td>61033021121</td></tr> <tr><td>61033221121</td><td>61033421121</td><td>61033621121</td><td>61034021121</td><td></td></tr> </tbody> </table>		61000421121	61000621121	61000821121	61001021121	61001221121	61001421121	61001621121	61001821121	61002021121	61002221121	61002421121	61002621121	61003021121	61003221121	61003421121	61003621121	61004021121	61030421121	61030621121	61030821121	61031021121	61031221121	61031421121	61031621121	61031821121	61032021121	61032221121	61032421121	61032621121	61033021121	61033221121	61033421121	61033621121	61034021121	
61000421121	61000621121	61000821121	61001021121	61001221121																																
61001421121	61001621121	61001821121	61002021121	61002221121																																
61002421121	61002621121	61003021121	61003221121	61003421121																																
61003621121	61004021121	61030421121	61030621121	61030821121																																
61031021121	61031221121	61031421121	61031621121	61031821121																																
61032021121	61032221121	61032421121	61032621121	61033021121																																
61033221121	61033421121	61033621121	61034021121																																	

DETAILS OF CHANGE:

1. 6100xx21121

DIMENSIONS

BEFORE CHANGE

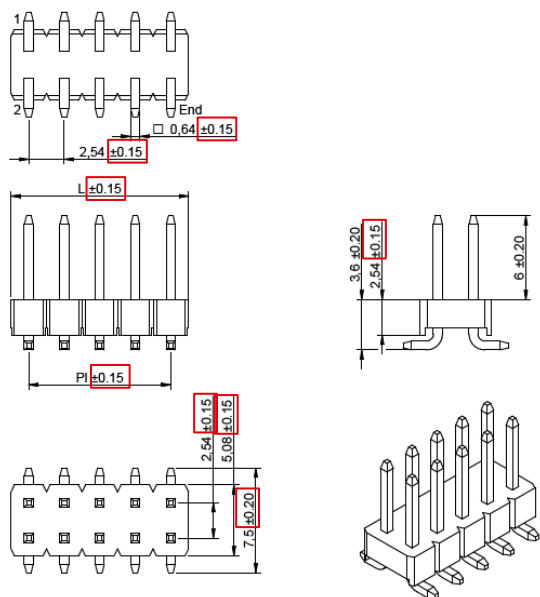

AFTER CHANGE

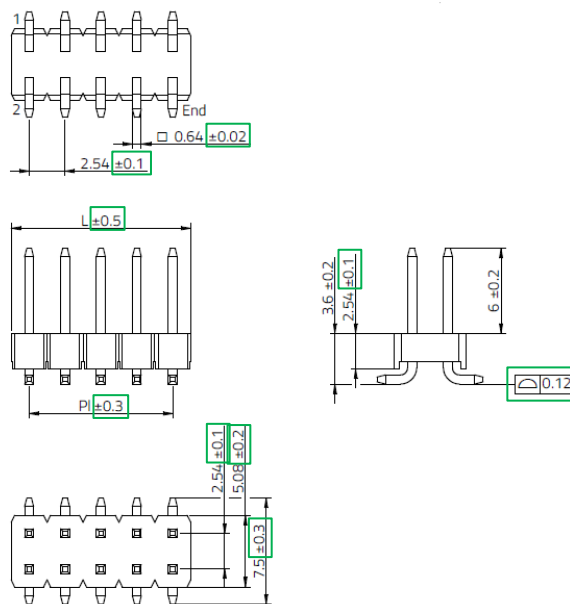

RECOMMENDED LAND PATTERN :

BEFORE CHANGE

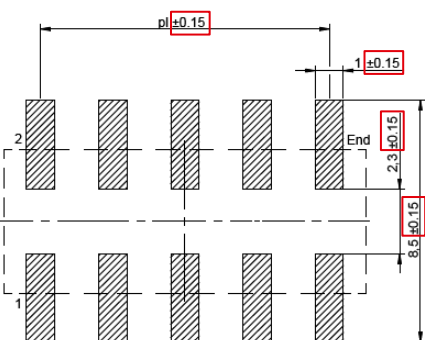

AFTER CHANGE

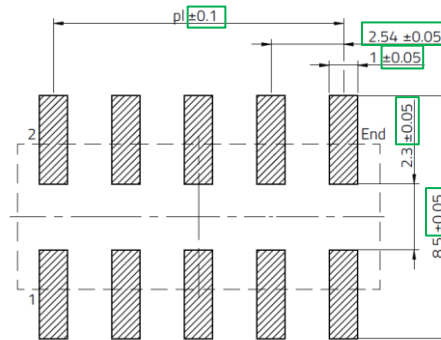

2. 6103xx21121

DIMENSIONS

BEFORE CHANGE

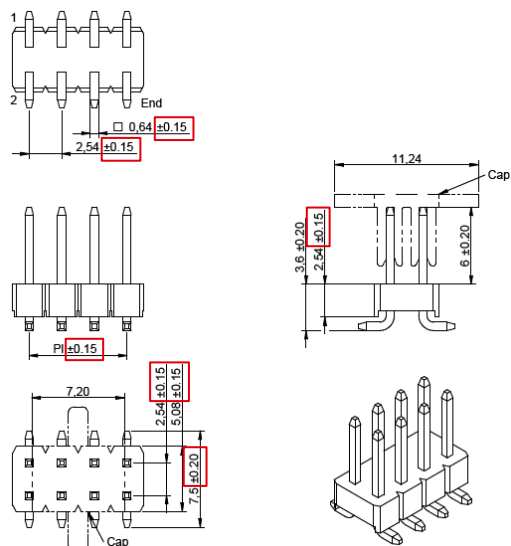

AFTER CHANGE

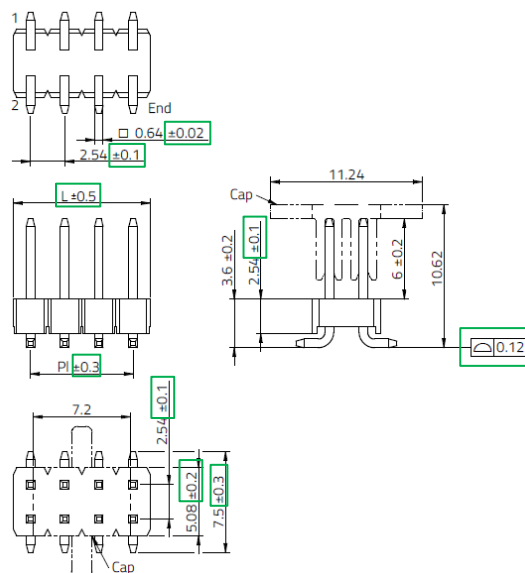

RECOMMENDED LAND PATTERN

BEFORE CHANGE

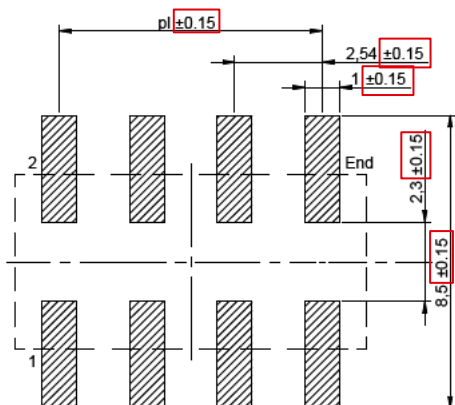

AFTER CHANGE

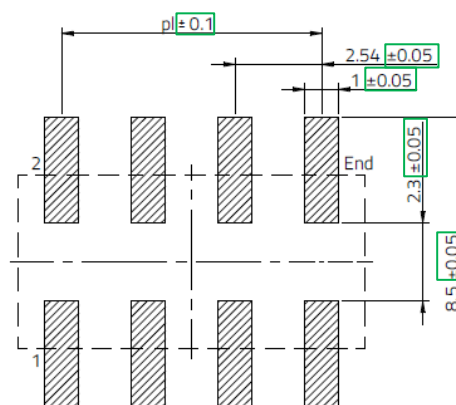

RELIABILITY / QUALIFICATION OF CHANGE:

There will be no change of the product, therefore no additional reliability or qualification testing was performed.