

RONDA-O-C

~50° 30° oval beam with holder C compatible
with LEDiL HEKLA

TECHNICAL SPECIFICATIONS:

Dimensions	Ø 53.9 mm
Height	20.5 mm
Fastening	socket
Colour	clear
Box size	
Box weight	0 kg
Quantity in Box	420 pcs
ROHS compliant	yes ⓘ

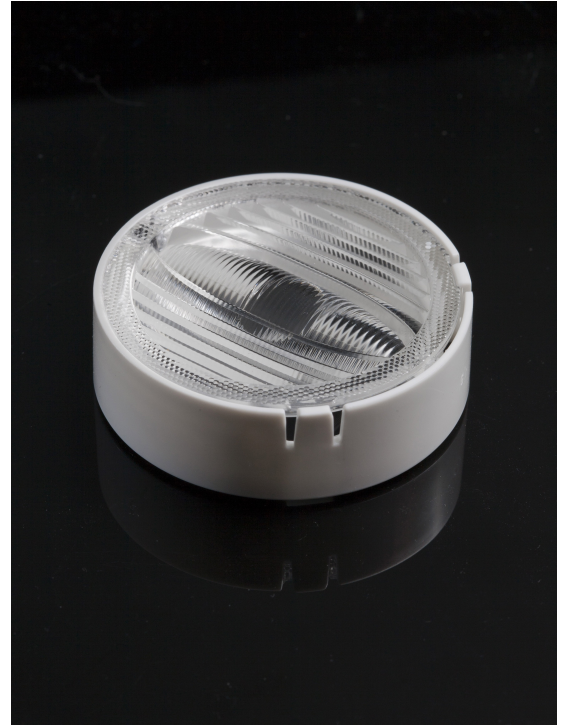

MATERIAL SPECIFICATIONS:

Component	Type	Material	Colour
RONDA-O	Lens	PMMA	clear
RONDA-HLD-C	Holder	PC	clear

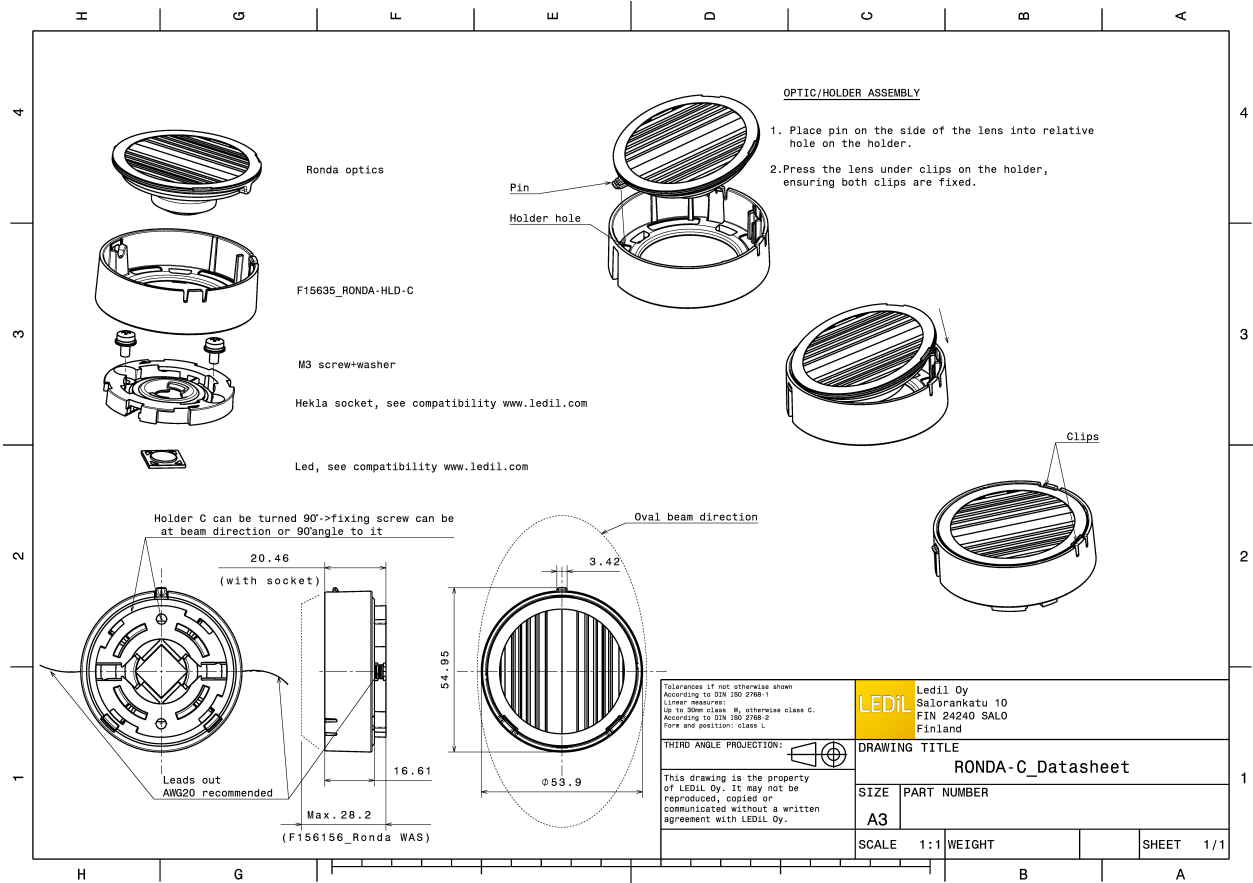

PHOTOMETRIC DATA (MEASURED):

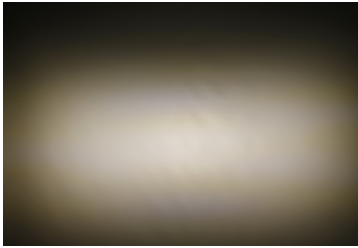
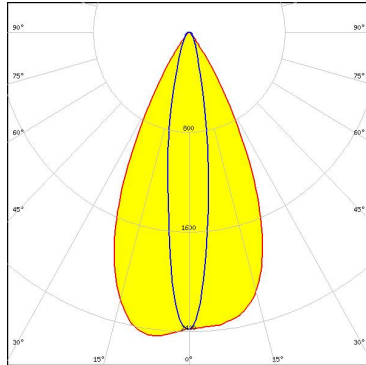
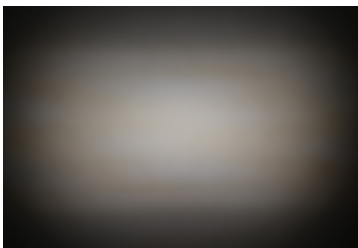
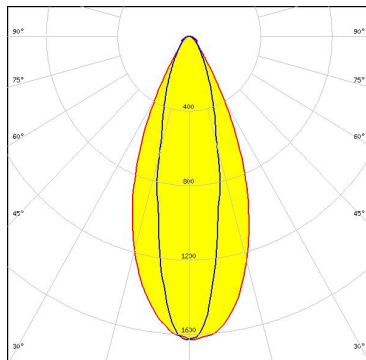
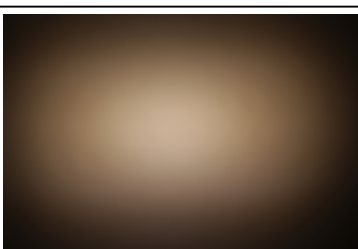
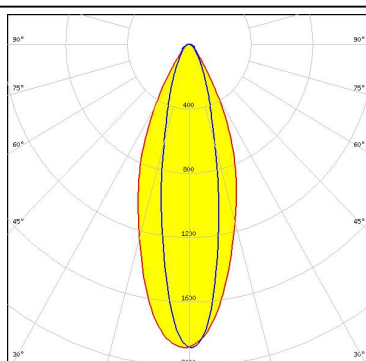
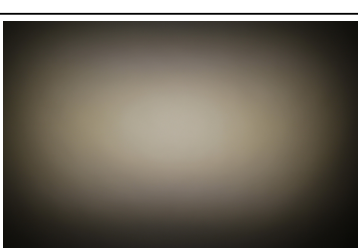
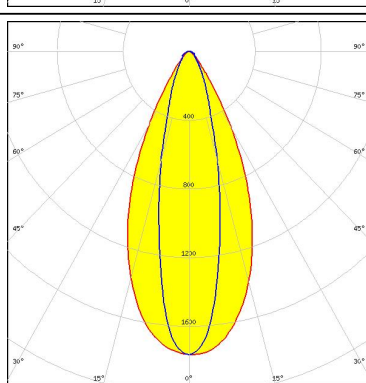
<p>bridgelux.</p> <p>LED V6 Gen6</p> <p>FWHM 50.0 + 17.0°</p> <p>Efficiency 91 %</p> <p>Peak intensity 2.400 cd/lm</p> <p>Required components: F15253_HEKLA-SOCKET-A</p>		
<p>bridgelux.</p> <p>LED Vesta TW 9mm (12W)</p> <p>FWHM 44.0 + 25.0°</p> <p>Efficiency 85 %</p> <p>Peak intensity 1.600 cd/lm</p> <p>Required components: C16142_HEKLA-SOCKET-K</p>		
<p>CITIZEN</p> <p>LED CLC020 Series (Dim-To-Warm)</p> <p>FWHM 29.0 + 23.0°</p> <p>Efficiency 84 %</p> <p>Peak intensity 1.900 cd/lm</p> <p>Required components: C16142_HEKLA-SOCKET-K</p>		
<p>CITIZEN</p> <p>LED CLL02x/CLU02x (LES10)</p> <p>FWHM 47.0 + 24.0°</p> <p>Efficiency 88 %</p> <p>Peak intensity 1.800 cd/lm</p> <p>Required components: F15255_HEKLA-SOCKET-C</p>		

PHOTOMETRIC DATA (MEASURED):

CITIZEN

LED CLU LES 4.2mm (HI-Ver.3)
 FWHM 49.0 + 14.0°
 Efficiency 91 %
 Peak intensity 3.000 cd/lm
 Required components:
 F15255_HEKLA-SOCKET-C

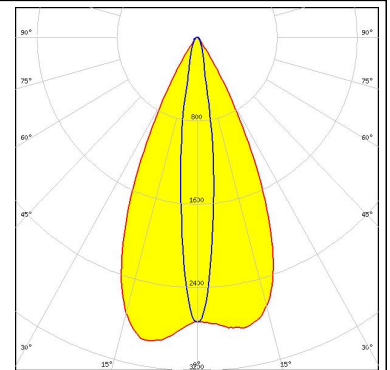
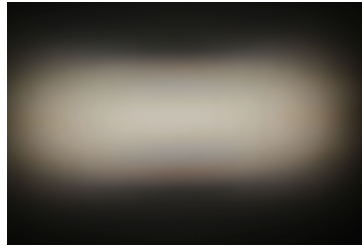

CITIZEN

LED CLU700/701
 FWHM 50.0 + 18.0°
 Efficiency 90 %
 Peak intensity 2.300 cd/lm
 Required components:
 F15255_HEKLA-SOCKET-C

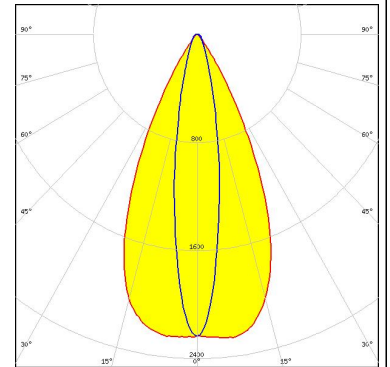
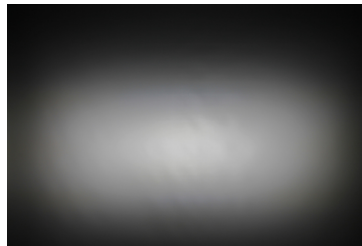

CREE

LED CMA1516
 FWHM 49.0 + 25.0°
 Efficiency 91 %
 Peak intensity 1.800 cd/lm
 Required components:
 F15256_HEKLA-SOCKET-D

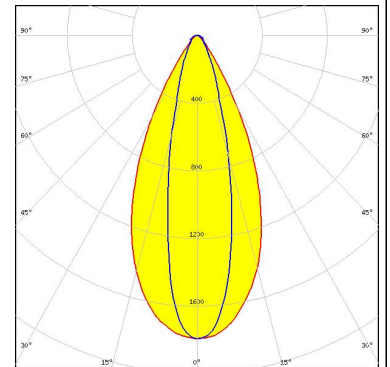
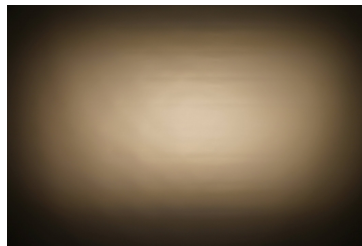

CREE

LED CMA1825
 FWHM 51.0 + 33.0°
 Efficiency 88 %
 Peak intensity 1.300 cd/lm
 Required components:
 F15254_HEKLA-SOCKET-B

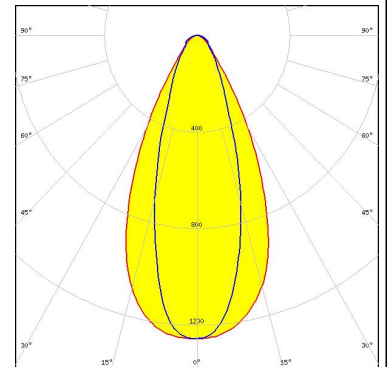
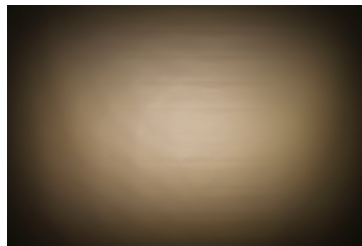

PHOTOMETRIC DATA (MEASURED):



LED CXA/B 13xx
 FWHM 50.0 + 17.0°
 Efficiency 91 %
 Peak intensity 2.400 cd/lm
 Required components:
 F15956_HEKLA-SOCKET-J

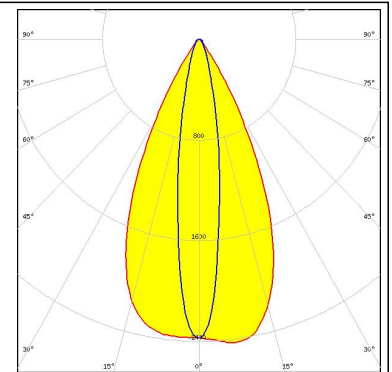
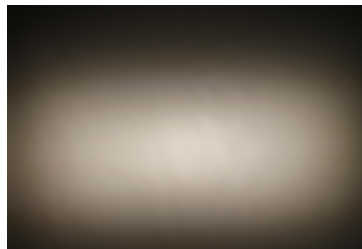

LED CXA/B 15xx
 FWHM 49.0 + 23.0°
 Efficiency 90 %
 Peak intensity 1.900 cd/lm
 Required components:
 F15256_HEKLA-SOCKET-D

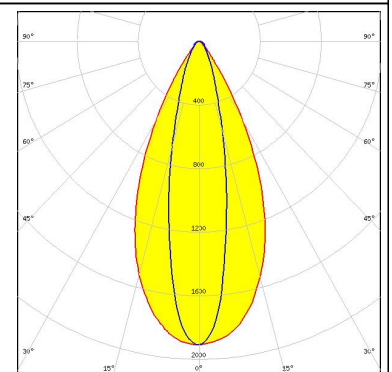
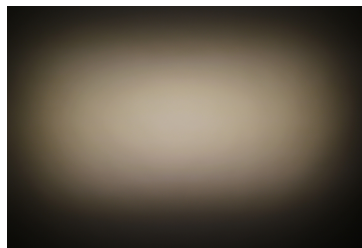

LED LUXEON CoB 1202s
 FWHM 51.0 + 17.0°
 Efficiency 91 %
 Peak intensity 2.300 cd/lm
 Required components:
 F15848_HEKLA-SOCKET-G

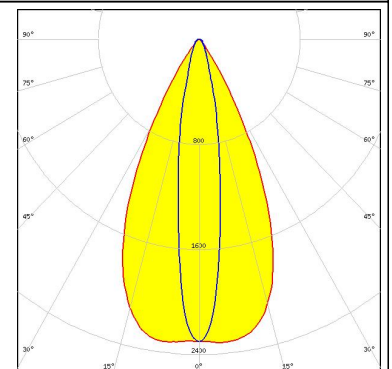
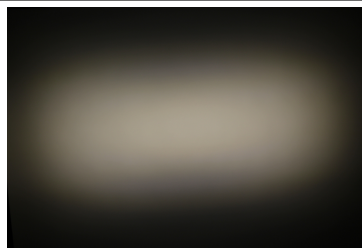

LED CXM-14
 FWHM 49.0 + 35.0°
 Efficiency 79 %
 Peak intensity 1.000 cd/lm
 Required components:
 F15859_HEKLA-SOCKET-I

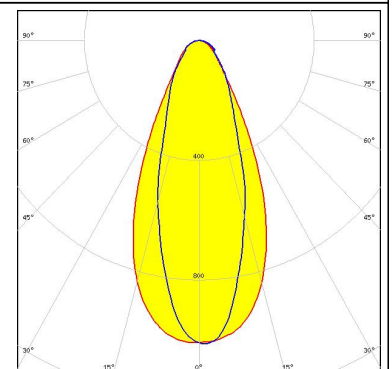
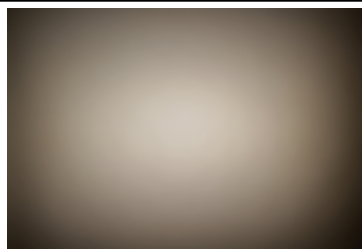

PHOTOMETRIC DATA (MEASURED):



LED CXM-9
 FWHM 47.0 + 25.0°
 Efficiency 89 %
 Peak intensity 1.800 cd/lm
 Required components:
 F15255_HEKLA-SOCKET-C

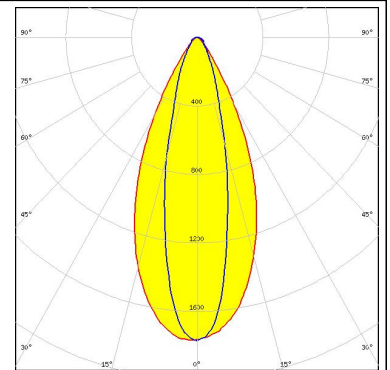

LED COB D Series LES 9.8 mm
 FWHM 48.0 + 25.0°
 Efficiency 89 %
 Peak intensity 1.700 cd/lm
 Required components:
 F15255_HEKLA-SOCKET-C

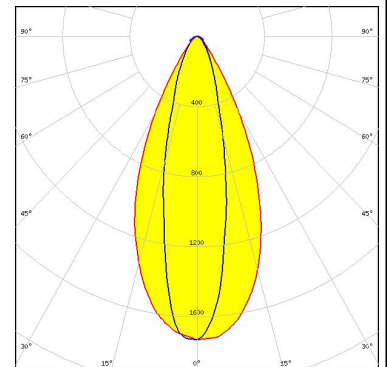
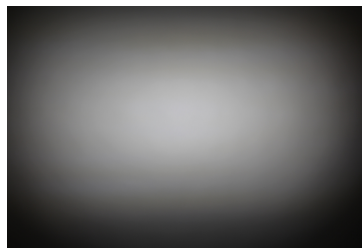

LED LC010C
 FWHM 52.0 + 18.0°
 Efficiency 90 %
 Peak intensity 2.100 cd/lm
 Required components:
 F15848_HEKLA-SOCKET-G

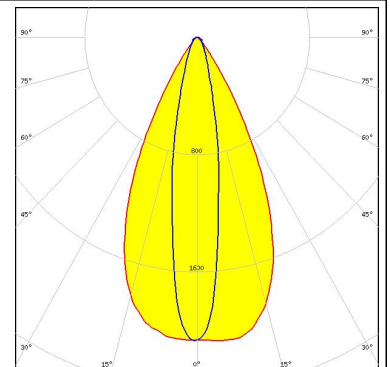
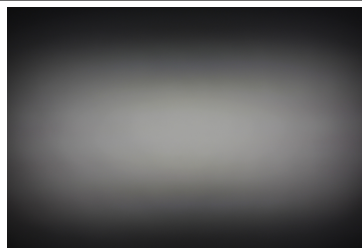

LED LC010C G2
 FWHM 50.0 + 17.0°
 Efficiency 89 %
 Peak intensity 2.300 cd/lm
 Required components:
 F15255_HEKLA-SOCKET-C

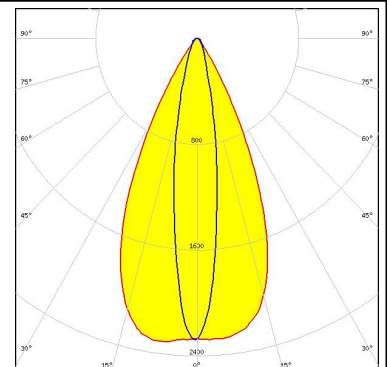
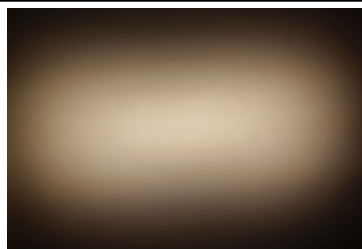

PHOTOMETRIC DATA (MEASURED):

SAMSUNG

LED LC020C
FWHM 49.0 + 22.0°
Efficiency 90 %
Peak intensity 1.900 cd/lm
Required components:
F15848_HEKLA-SOCKET-G

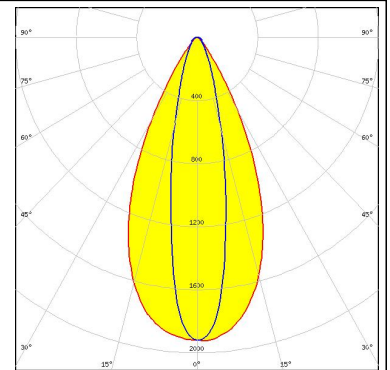

XICATO

LED XTM - 19mm LES
FWHM 57.0 + 40.0°
Efficiency 82 %
Peak intensity 0.790 cd/lm
Required components:
C16058_XTM-ADAPTER-50-C

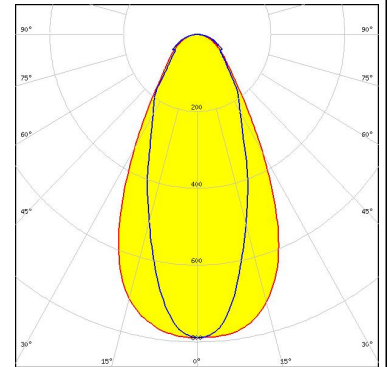

PHOTOMETRIC DATA (SIMULATED):



LED COB T-Type
FWHM 28.0 + 47.0°
Efficiency 86 %
Peak intensity 2.470 cd/lm
Required components:
F15848_HEKLA-SOCKET-G

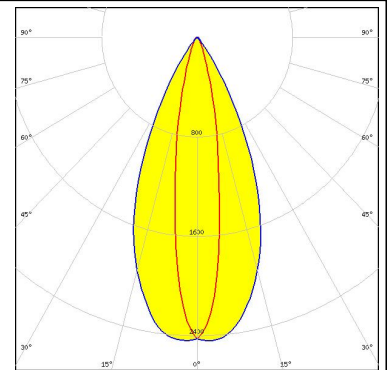

LED SLE G6 LES10
FWHM 20.0 + 45.0°
Efficiency 94 %
Peak intensity 2.300 cd/lm
Required components:
F15255_HEKLA-SOCKET-C

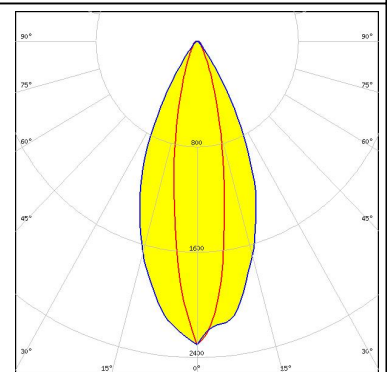

GENERAL INFORMATION:

NOTE: The typical beam angle will be changed by different color, chip size and chip position tolerance. The typical total beam angle is the full angle measured where the luminous intensity is half of the peak value.

Due to use of high power COB's with this product, special attention to proper thermal design is highly recommended. LEDiL has no liability for direct, indirect or consecutive damages arising from the LEDiL products being used outside of the recommended temperature range.

MATERIALS:

As part of our continuous research and improvement processes, and to ensure the best possible quality and availability of our products, LEDiL reserves the right to change material grades without notice.

PRODUCT DATA USER AGREEMENT AND DISCLAIMER:

The measured data in the provided downloadable LEDiL Product Datasheets and Mechanical 2D-Drawings is rounded and provided as reference for planning. LEDiL Oy's optical specifications have been verified by conducting performance testing of the products in accordance with the company's quality system. The reported data are averaged results of multiple measurements with typical variation. LEDiL Oy reserves the right to without prior notification make changes and improvements to its products.

LEDiL Oy assumes neither warranty, nor guarantee nor any other liability of any kind for the contents and correctness of the provided data. The provided data has been generated with highest diligence but the provided data may in reality not represent the complete possible variation range of all intrinsic parameters. Therefore, in certain cases a deviation from the provided data could occur.

LEDiL Oy reserves the right to undertake technical changes of its products without further notification which could lead to changes in the provided data. LEDiL Oy assumes no liability of any kind for the possible deviation from any provided data or any other damage resulting from the usage of the provided data.

The user agrees to this disclaimer and user agreement with the download or usage of the provided files.

LEDiL Oy

Joensuunkatu 13
FI-24240 SALO
Finland

LEDiL Inc.

228 West Page Street
Suite D
Sycamore IL 60178
USA

Local sales and technical support

www.ledil.com/where_to_buy

Shipping locations

Salo, Finland
Hong Kong, China

Distribution Partners

www.ledil.com/where_to_buy