



Instantaneous relay



Latching relay



Fleeting contact relay

The range

The range of RH plug-in control relays with single socket type common to all models and standard front face includes the following models of 5 A relays with 4 C/O contacts, for a.c. and d.c. control:

- instantaneous relays,
- mechanical latching relays (memory relays),
- time delay relays,
- fleeting contact relays,
- flashing relays,
- sequencer step module.

Miniaturisation

The RH relay is designed to provide true miniaturisation, combining minimum installation size with:

- ensured dielectric strength for hard-wired equipment,
- standard pattern contact points compatible with automatic wiring methods,
- direct accessibility to connection points when wiring.

Vibration resistance

The highly versatile RH range offers numerous mounting and wiring possibilities for use in a wide variety of automation equipment installations.

The vibration resistance (severity 55 A conforming to IEC 68-2-6) quoted on pages 28002/2 and 28002/5 are for back wired sockets clipped onto a rigid plate, or for front wired sockets screwed onto a rigid panel.

Front face

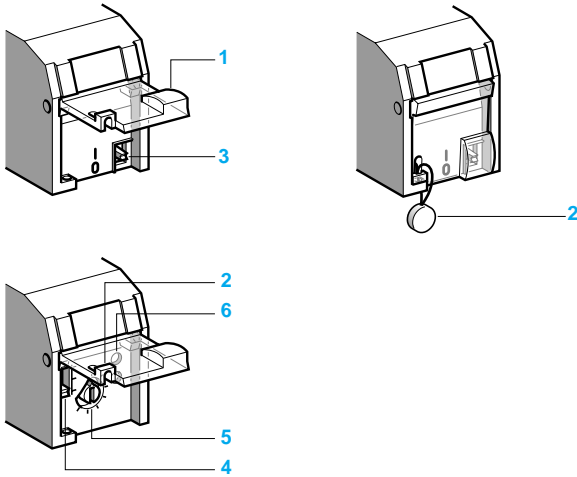

The front of all RH relays have a standard appearance.

The self-adhesive function legend is placed at the top. This legend can be made up and positioned by the user as required.

The hinged flap **1** has three functions:

- acts as an extractor pull tab,
 - provides protection against dust and accidental adjustment of settings accessible on the front face: operator, indicators, etc,
 - sealing **2** of these active components if necessary.
- In operation, the flap must always be down.

The active components differ according to the relay function, ie:

- for instantaneous and latching relays:
 - manual operator **3**,
 - mechanical state indicator **3**,
- for time delay, fleeting contact and flashing relays:
 - timing range selector switch **4**, display **5**,
 - 1 or 2 relay state indicators **6**.

Base

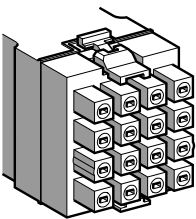

All RH relays have the same type of base, with outlets evenly spaced at 7.62 mm intervals, both vertically and horizontally.

This triple 2.54 mm module allows:

- the use of automatic wiring methods,
- the establishment of leakage paths, so ensuring a dielectric strength of 2500 V with the relay wired.

Also, the outlets are protected female sockets which makes it possible:

- to provide mechanical protection for these outlets during transport and installation,
- to incorporate within the relay (a plug-in and replaceable component) all active components, including plug-in connection clips (note that inside the relay, each contact carrier plate and its corresponding output connection clip are in one piece, with no soldered joints),
- to keep within the socket (a fixed and wired component) only very simple male conductor components, which makes these sockets very reliable.

Locking the relay into the socket

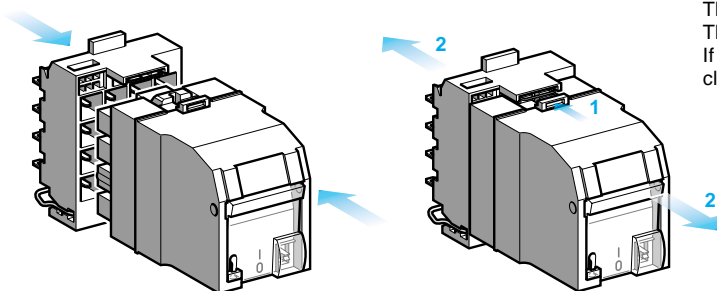

RH relays clip securely into their socket.

They are released by pressing the release tabs with a screwdriver or a finger.

The relay can then be removed by simply pulling the extractor pull tab **1**.

If the relay is accidentally released, it must be fully extracted before being clipped back into place.

RH relay operating position

The normal mounting position, with front face vertical and extractor pull tab pointing down is shown in the figure above.

The label gives the wiring scheme for the device together with other information (type, rating, voltage, etc).

Mounting the relay in any other position has virtually no effect on its operating characteristics.

RH sequencer

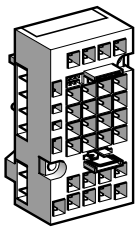
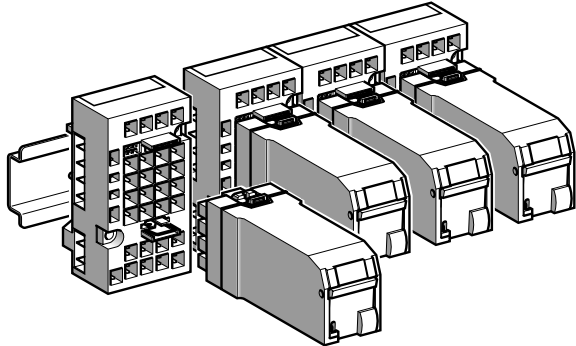

RHZ-42

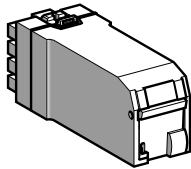

RHK-412●

The analysis of an industrial process generally involves breaking it down into a succession of clearly defined basic tasks or actions, performed in a set order (opening a valve, for example, followed by starting a mixer, etc.).

The end of one operation generally establishes the start of the next operation. The RH sequencer is a simple way of controlling this type of process. Acting as the backbone of the automated system, it consists of a series of "step modules", one for each step in the sequential process.

Sequencer composition

Each "step module" in the sequencer consists of :

- an RHK-412 mechanical latched relay, with d.c. coil,
- a special socket, RHZ-42. The sockets clip onto a 35 mm rail and also plug into each other sideways, so providing electrical connection between themselves.

The sequencer is therefore made up of one or more rows, as required, of modules which plug and clip together to form the internal basic scheme of the sequencer, without any need for wiring between sockets.

Step module scheme

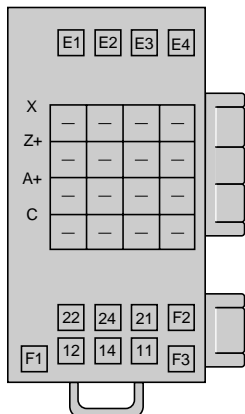
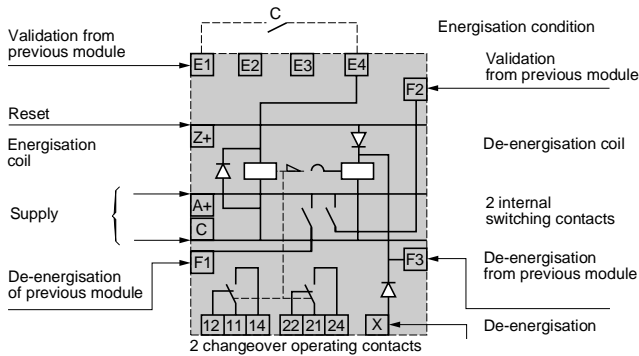

The latching relay in each module comprises :

- 2 internal switching contacts,
- 2 changeover operating contacts.

When the step module is activated, the energising coil actuates these 4 contacts :

- one of the internal switching contacts deactivates the previous module;
- the other internal switching contact supplies the validation circuit for the next module,
- the 2 operating changeover contacts are available for switching actions associated with the step (motors, etc.).

Socket RHZ-42 Terminal marking

Supply terminal

The following polarities must be complied with :

- Z+ : general reset.
- A+ : + supply to the sequencer.
- C : - supply.

All Z+, A+ and C terminals in a horizontal row of step modules are electrically connected to each other.

Control terminals

Between E1 and E4, wiring of energisation condition(s).

E2, E3 : spare terminals.

For logic connections required between non-adjacent modules :

- F1 = Sends reset instruction "n",
- F2 = Sends validation instruction "n",
- F3 and X = Receives reset instruction,
- E1 = Receives validation instruction.

Terminal X is equivalent to terminal F3 but introduces a non-return diode, located in the socket, into the wired reset circuit. It is used in certain circuits, in particular for the step preceding a jump of one or more steps. Please consult the technical manual on the "RH Electrical Sequencer" for more detailed information.

RH relays, all models

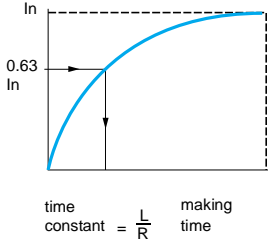

Time constant

This is the ratio L/R , expressed in milliseconds, between the inductance and the resistance of a load.
The time taken for the current to establish within a load, switched by an RH relay contact for example, depends on the time constant for this load, or more precisely for the whole of the circuit.

Breaking

The breaking time with d.c. control depends on the time constant of the circuit and also on the opening distance of the switching contact : the inductive energy ($1/2 Li^2$) is in fact dissipated in the arc which appears at the contact terminals.
With a.c. control, breaking occurs when the current passes through zero.
When a contact opens, an overvoltage is created at its terminals; the higher the inductance of the circuit and the faster the contact opens, the higher the overvoltage ($u = L.di/dt$).

Variable quantities

All quantities (ambient temperature, supply voltage...) whose variations are likely to affect operation of the relay.

Rated thermal current

The highest value of current (rms value for a.c.) which a closed contact can sustain continuously, under the conditions specified by the manufacturer, without its temperature rise exceeding the limits given in the standards.

Making current

The highest value of current (rms value for a.c.) which a contact is capable of making onto.

Breaking current according to the number of operating cycles

With d.c. control, this is the ensured value of the current broken in a resistive or inductive circuit, with a given time constant, at a voltage U and for a specified number of operating cycles.

It is also often expressed as power broken in W (it is in fact a fictitious power in $VA =$ the product of I before breaking, multiplied by U at the contact terminals after breaking).

With a.c. control, this is the value in amps of the current broken in a resistive or inductive circuit, for a given power factor ($\cos \phi$), at a voltage U and for a specified number of operating cycles.

It is also often expressed in VA .

RH time delay relays

Repeat accuracy

Repeat accuracy defines the variation in time delays obtained on a single relay, for a series of successive operating cycles, without modifying the setting and at rated conditions for temperature, voltage, etc

Setting accuracy

This is the maximum ensured differential between the time delay set and the time delay actually obtained, under normal conditions. This differential is expressed as a % of the time delay per unit variation in the variable quantity (or for the total permissible variation range).

Stability according to variations in variable quantities

For each variable quantity, and within a permissible variation range, this is expressed as % drift of the time delay per unit variation in the variable quantity (or for the total permissible variation range).

Time delay

- The time delay
 - at switch-off or
 - On-delay or
 - on energisation
 starts as soon as supply to the control circuit is switched on.
- The time delay
 - at switch-off or
 - Off-delay or
 - on de-energisation
 starts as soon as supply to the control circuit is switched off.

Reset time

Minimum time required between the end of one time delay cycle and the start of the next.

Plug-in relays

RH control relays
Instantaneous (RHN) and latching (RHK)

Type			RHN	RHK	
Environment					
Classification	Standard version		EDF, BV, USSR		
Conforming to standards	Standard version		IEC 255, NF C 45-250, VDE 0435, BS 4794		
Product approvals	Standard version		CSA, ASE, UR	CSA, ASE, UR	
Protective treatment	Standard version		"TC"	"TC"	
Rated insulation voltage		V	250	250	
Dielectric strength (relay "wired")		V	2500	2500	
Ambient air temperature around the device	Storage	°C	- 40...+ 70	- 40...+ 70	
	Operation (Conforming to 1C of IEC 255)	°C	- 5...+ 40	- 5...+ 40	
	Permissible for operation between 0.85 and 1.1 Un	°C	- 25...+ 60	- 25...+ 60	
Operating positions			Any	Any	
Vibration resistance	Conforming to NF C 20-616 and IEC 68-2-6	Severity 55 A	6 g (10...55 Hz)	6 g (10...55 Hz)	
Shock resistance	Conforming to NF C 20-608	Severity 50 A	50 g - 11ms	30 g - 11ms	
Contact characteristics					
Number of contacts			4 C/O	4 C/O	
Rated thermal current	For temperature ≤ 40 °C	A	5 (RHN-41●●)	5 (RHK-41●●)	
			1 (RHN-42●●)	1 (RHK-42●●)	
Minimum switching capacity	At U min : 1 V or I min : 10 mA	mVA	150 (RHN-41●●)	150 (RHK-41●●)	
	At U min : 1 V or I min : 1 mA	mVA	50 (RHN-42●●)	50 (RHK-42●●)	
Bounce time	Maximum duration of a bounce ≤ 2 ms	ms	≤ 10	≤ 10	
Volt drop	For 3 A at 24 V	mV	≤ 100	≤ 100	
Average resistance of contacts	Socket + relay at 20 °C	mΩ	30	30	
Changeover time	a.c. control circuit	De-energising/Energising	ms	0.5...6	0.5...6
		Energising/De-energising	ms	1...3	1...3
	d.c. control circuit	De-energising/Energising	ms	1.2...4	1.2...4
		Energising/De-energising	ms	1...4	1...4

Plug-in relays

RH control relays

Instantaneous (RHN) and latching (RHK)

Type				RHN	RHK	
Control circuit characteristics						
Average consumption at 20 °C					Coil n° 1 Coil n° 2	
	a.c. control	Inrush	VA	4.5	6	2.5
		Holding	VA	2.5	3.5	1.3
	d.c. control	Inrush or Holding	W	1.6	1.6	2.9
Permissible voltage variation	Conforming to 1 C of IEC 255			0.8...1.1 U _c	0.8...1.1 U _c	
Drop-out voltage	d.c. control			0.10...0.3 U _c	0.10...0.3 U _c	
	a.c. control			0.15...0.5 U _c	0.15...0.5 U _c	
Cos φ (a.c. control)		Inrush		0.6	0.6	
		Holding		0.7	0.7	
L/R (d.c. control)	L/R, magnetic circuit	Open	ms	12	12	
		Closed	ms	15	15	
Other characteristics						
Mechanical life (at U _c)	In millions of operating cycles			20	10	
Maximum operating rate	In operating cycles per second			6	2	
Operating time (at rated voltage and at 20 °C)	Between coil energisation and making of N/O contact	a.c. control	ms	2...15	5...17	
		d.c. control	ms	10...20	12...22	
	Between coil de-energisation and making of N/C contact	a.c. control	ms	1.2...12	–	
		d.c. control	ms	2...7	–	
	Between energisation of trip coil and making of N/C contact	a.c. control	ms	–	8...16	
		d.c. control	ms	–	10...14	
Minimum pulse duration	For latching or tripping of RHK latch relay		ms	–	≥ 50	

Plug-in relays

RH control relays
Time delay (RHT or RHR), fleeting contact (RHE or RHD),
flashing (RHC)

Type			RHT, RHR	RHE, RHD	RHC	
Environment						
Classification	Standard version		EDF, BV, USSR			
Conforming to standards	Standard version		IEC 255, NF C 45-250, VDE 0435			
Product approvals	Standard version		CSA, ASE	CSA, ASE	CSA, ASE	
Protective treatment	Standard version		"TC"	"TC"	"TC"	
Rated insulation voltage		V	250	250	250	
Overvoltage protection	Conforming to IEC 255-5		3 kV, 0.5 Joule	3 kV, 0.5 Joule	3 kV, 0.5 Joule	
Dielectric strength, relay "wired"		V	2500	2500	2500	
Ambient air temperature around the device	Storage	°C	- 40...+ 70	- 40...+ 70	- 40...+ 70	
	Operation (Conforming to 1 C of IEC 255)	°C	- 5...+ 40	- 5...+ 40	- 5...+ 40	
	Permissible for operation between 0.85 and 1.1 Un	°C	- 25...+ 60	- 25...+ 60	- 25...+ 60	
Operating positions			Any	Any	Any	
Vibration resistance	Conforming to NF C 20-616 and IEC 68-2-6	Severity 55 A	6 g (10...55 Hz)	6 g (10...55 Hz)	6 g (10...55 Hz)	
Shock resistance	Conforming to NF C 20-608	Severity 50 A	50 g - 11 ms	50 g - 11 ms	50 g - 11 ms	
Contact characteristics						
Number of contacts			4 C/O	4 C/O	4 C/O	
Rated thermal current	For temperature ≤ 40 °C	A	5 (RH-41●●) 1 (RH-42●●)	5 (RH-41●●) 1 (RH-42●●)	5 (RHC)	
Minimum switching capacity	At U min: 1 V or I min: 10 mA	mVA	150 (RH-41●●)	150 (RH-41●●)	150 (RHC)	
	At U min: 1 V or I min: 1 mA	mVA	50 (RH-42●●)	50 (RH-42●●)	–	
Bounce time	Maximum duration of bounce ≤ 2 ms	ms	≤ 10	≤ 10	≤ 10	
Volt drop	For 3 A at 24 V	mV	≤ 100	≤ 100	≤ 100	
Average resistance	Socket + relay at 20 °C	mΩ	30	30	30	
Changeover time	a.c. control circuit	De-energising/Energising	ms	0.5...6	0.5...6	0.5...6
		Energising/De-energising	ms	1...3	1...3	1...3
	d.c. control circuit	De-energising/Energising	ms	1.2...4	1.2...4	1.2...4
		Energising/De-energising	ms	1...4	1...4	1...4

Plug-in relays

RH control relays
Time delay (RHT or RHR), fleeting contact (RHE or RHD),
flashing (RHC)

Type			RHT, RHR	RHE, RHD	RHC		
Control circuit characteristics							
Average consumption at 20 °C	Output state 1	a.c. control	VA	2.9	2.9	2.9	
		d.c. control	W	2.5	2.5	2.5	
	For 220 V a.c.		VA	3.5	3.5	3.5	
Permissible voltage variation	Conforming to 1 C of IEC 255			0.8...1.1 Uc	0.8...1.1 Uc	0.8...1.1 Uc	
External control contact	Type (only)			Mechanical	Mechanical	Mechanical	
Other characteristics							
Mechanical life (at Uc)	In millions of operating cycles			20	20	20	
Status indication	During time delay period (Green LED)			Illuminated	–	–	
	On making of on-delay contacts (Red LED)			Illuminated	Illuminated	Illuminated	
Time delay (adjustable by potentiometer on front face)	3 setting ranges (selected by switch on front face)			Normal	Long	–	–
		s	0.2...3	1.25...24	–	–	
		s	1.5...30	12.5...240	–	–	
		s	15...300 s	2...4 min	–	–	
	Repeat accuracy			± 1 %	–	–	
	Setting accuracy (1)	Normal time delay			± 15 %	–	–
		Long time delay			± 20 %	–	–
Reset time			ms	≤ 100	–	–	
Stability to influence quantities	Temperature (range : - 5...+ 40 °C) per °C around 20 °C			0.14 %	–	–	
	Voltage (range : 0.8...1.1 Uc) for extreme limits		ms	± 20	–	–	
Immunity to micro-breaks	During time delay period		ms	Up to 10	–	–	
	After time delay period		ms	Up to 2	–	–	
Fleeting contacts	Fleeting contact time		ms	–	200	–	
	Tolerance		ms	–	- 20...+ 100	–	
	Response time at Uc and at 20 °C		ms	–	10...30 (RHE)	–	
			ms	–	35...65 (RHD)	–	
Flashing relay symmetrical contact time	Adjustable by potentiometer on front face			–	–	0.5...5 or 2...30	

(1) % of the maximum value of the range selected

Plug-in relays

RH control relays

Sockets and termination adaptor for front wiring

Sockets					
Type		RHZ-11	RHZ-12	RHZ-13	
Cabling		With 2.8 x 0.5 tags for soldering or Faston connectors	With 0.8 x 1.6 x 22 mm pins for wire-wrap or termi-point at 7.62 (3 x 2.54 mm) centres	With 0.8 x 0.8 x 4.3 mm solder pins for printed circuit board at 7.62 (3 x 2.54 mm) centres	
Rated thermal current	A	5	5	5	
Dielectric strength	V	2500	2500	2500	
Protection against direct finger contact		Yes	Yes	Yes	
Function marking facility		Using three AB1-R or AB1-G clip-in characters or AB1-SA1 blank clip-in legend plate			
Relay-socket locking		By simply clipping in the relay. To release, press the 2 red locking tabs. Warning : if accidentally released, the relay must be fully extracted before being clipped back into place.			
Cabling capacity		Solder tags, flexible cable 1 x 1.5 mm ² or 2 x 1 mm ²	3 connections max. per termi-point pin, flexible cable	On all printed circuit boards 2.54 mm pitch, see page 28004/2	
		Faston connector, flexible cable 1 x 1.5 mm ² or 2 x 0.34 at 1 mm ²	AWG	I max	
			22	5 A	
			24	3 A	
			26	2.4 A	Side cover allows cleaning products to drain awayn socket resistant to these products
		Solder tags, rigid cable 2 x 1 mm ²	Wire-wrap, rigid cable		
	AWG		I max		
	20		7.5 A		
	22		5 A		
		24-26	2.4 A		

Termination adaptor			
Type		RHZ-15	
Wiring	Front	Screw clamp terminals with 8 mm connector plates	
	Back	Double tags for soldering or 2.8 x 0.5 Faston connectors and 0.8 x 1.6 x 22 mm pins for wire-wrap or termi-point	
Cabling capacity		Screw clamp terminals : 1 or 2 x 1.5 mm ² or 1 x 2.5 mm ² for flexible or rigid cable	
		Tags and wire wrap or termi-point pins : see above RHZ-11 and RHZ-12	
Rated thermal current	A	5	
Dielectric strength	V	2500	
Marking facility		Using three AB1-R or AB1-G clip-in characters per terminal	

Plug-in relays

RH control relays

Sockets and termination adaptors for front wiring

Sockets

Type		RHZ-21	RHZ-22	RHZ-24	RHZ-42
Cabling		Screw clamp terminals	Double tags for Faston connectors 2.8 x 0.5	Double tags for Faston connectors 4.8 x 0.8	Single tags for Faston connectors 2.8 x 0.5
Rated thermal current	A	5	5	5	5
Dielectric strength	V	2500	2500	2500	2500
Protection against direct finger contact		Yes	Yes	Yes	Yes
Function marking facility		Using 4 clip-in characters AB1-R or AB1-G blank clip-in legend plate AB1-SA1			
Relay-socket locking		By simply clipping in the relay. To release, press the 2 red locking tabs. Warning : If accidentally released, the relay must be fully extracted before being clipped back into place.			
Cabling capacity	mm²	Flexible or solid cable 2 x 2.5 max 2 x 0.5 min	Flexible cable 2 x 1.5 max 2 x 0.34 min	Flexible cable 2 x 1.5 max 2 x 0.34 min	Flexible cable 2 x 1.5 max 2 x 0.34 min

Termination adaptor

Type		RHZ-25			
Wiring	Bottom connection	Screw clamp terminals with 8 mm connector plates			
	Centre connection	Double tags for soldering or 2.8 x 0.5 mm Faston connectors			
	Top connection	Single pins, 0.8 x 1.6 x 22 mm for wire-wrap or termi-point, maximum of 3 connections.			
Cabling capacity		Screw terminals, flexible or rigid cable 1 or 2 x 0.5 to 1.5 mm ² or 1 x 2.5 mm ²			
		Tags, flexible cable 1 or 2 x 0.34 to 1 mm ² or 1 x 1.5 mm ² , rigid cable 1 or 2 x 1 mm ²			
		Faston connectors, flexible cable 1 or 2 x 0.34 to 1.5 mm ² or 1 x 1.5 mm ²			
		Wire-wrap pins, rigid cable		Termi-point pins, flexible cable	
		AWG	I max	AWG	I max
		20	7.5 A	22	5A
	22	5 A	24	3 A	
	24-26	2.4 A	26	2.4 A	
Rated thermal current	A	5			
Dielectric strength	V	2500			
Function marking facility		Using 4 clip-in characters AB1-R or AB1-G per terminal			

Electrical life of normal contacts

a.c. control

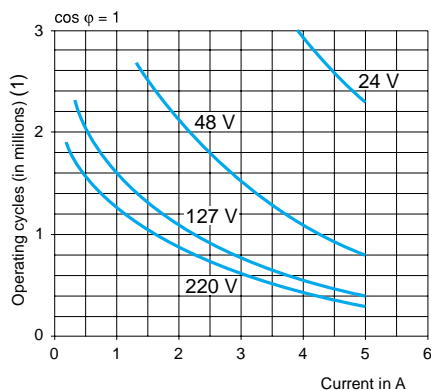

Curves at 1 operating cycle/second

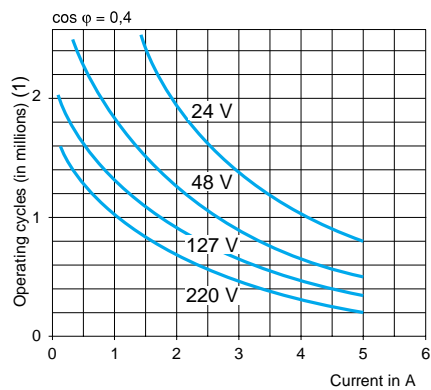

Curves at 1 operating cycle/second

Motor control

10 In : $\cos \varphi = 0,7$ and in : $\cos \varphi = 0,4$

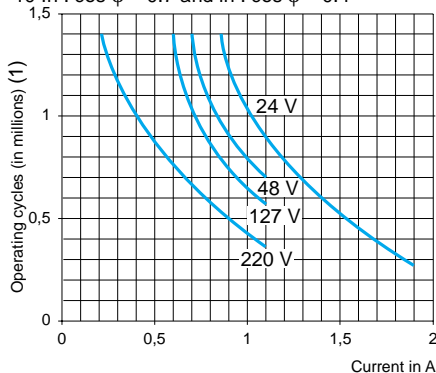

Curves at 1200 operating cycles/hour

d.c. control

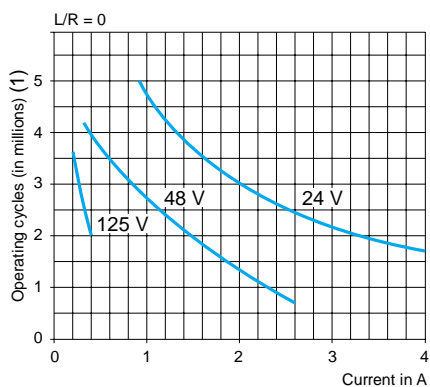

Curves at 1 operating cycle/second

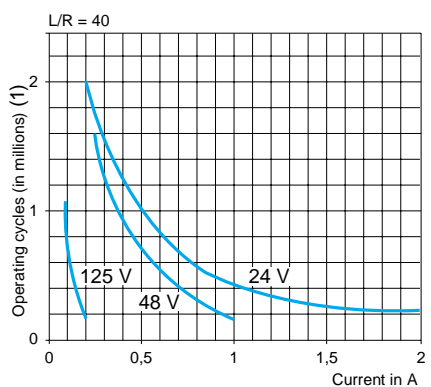

Curves at 720 operating cycles/hour

(1) Number of operating cycles according to current broken

Operating diagrams

**Time delay relay
RHT on-delay**

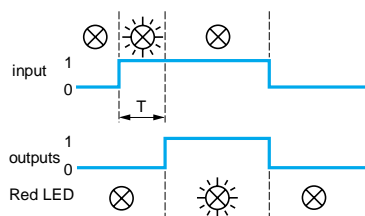

T : time delay

**Fleeting contact relay
RHE on energisation**

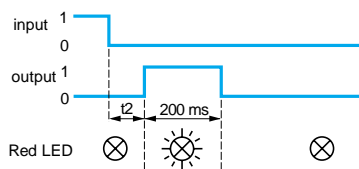

t1 : 20...40 ms

Flashing relay RHC

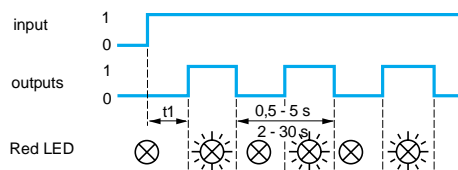

t1 : 20...40 ms

**Time delay relay
RHR off-delay**

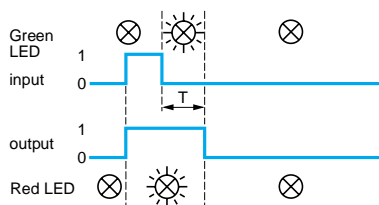

T : time delay

**Fleeting contact relay
RHD on de-energisation**

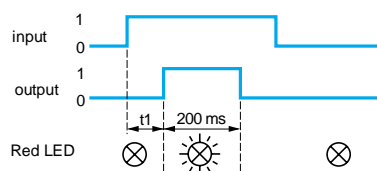

t2 : 10 ...30 ms

Plug-in relays

RH control relays
with 4 C/O contacts for control circuit : \sim or ---

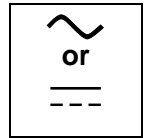

RHN-411M



RHK-411M

Instantaneous relays

Description	Control circuit voltage	Basic reference complete with code indicating control voltage (2)	Normal voltages	Weight kg
Relays with normal contacts				
	50 Hz	RHN-411●	B E F M	0.090
	60 Hz	RHN-416●	JV DE KC	0.090
	---	RHN-412●	B E F	0.090
Relays with low level contacts				
	50 Hz	RHN-421●	B E F M	0.090
	60 Hz	RHN-426●	JV DE KC	0.090
	---	RHN-422●	B E F	0.090
Relays with built-in interference suppression diode	Normal contacts	---	RHN-412●A76	0.090
	Low level contacts	---	RHN-422●A76	0.090

Latching relays

Relays with normal contacts				
	50 Hz	RHK-411●	B E F M	0.140
	60 Hz	RHK-416●	JV DE KC	0.140
	---	RHK-412●	B E F	0.140
Relays with low level contacts				
	50 Hz	RHK-421●	B E F M	0.090
	60 Hz	RHK-426●	JV DE KC	0.090
	---	RHK-422●	B E F	0.090
Relays with built-in interference suppression diode	Normal contacts	---	RHK-412●A76	0.090
	Low level contacts	---	RHK-422●A76	0.090

(2) Standard control circuit voltages

Volts	5	6	9	12	24	36	42	48	60	72	110	120	125	127	208	220	230	240
50 Hz	—	—	—	J	B	—	D	E	—	—	F	—	—	G	—	M	UG	U
60 Hz	—	—	—	JL	JV	—	—	DE	—	—	KC	KF	—	—	GL	GP	LC	LF
---	JX	R	JJ	J	B	C	D	E	P	EN	F	—	G	—	—	M	—	U

Coil characteristics (RHN relays)

Rated control voltage V	a.c. voltages 50 or 60 Hz					d.c. voltages ---		
	Frequency Hz	Average R at 20 °C Ω	Inrush current mA	Holding current mA	L H	Average R at 20 °C Ω	Current mA	L H
5	—	—	—	—	—	15.1	331.1	0.21
6	—	—	—	—	—	15.1	397.4	0.21
9	—	—	—	—	—	46.9	191.9	0.65
12	50	11	483.3	258.3	0.1	76.5	156.9	1.06
12	60	8.8	533.3	275	0.0.8	—	—	—
24	50	43.4	241.7	129.2	0.41	276	87	3.84
24	60	34.9	266.7	137.5	0.33	—	—	—
36	—	—	—	—	—	686	52.5	9.54
42	50	156	138.1	73.8	1.27	876	47.9	12.18
48	50	200	120.8	64.6	1.66	1100	43.6	15.29
48	60	156	133.3	68.8	1.31	—	—	—
60	—	—	—	—	—	1862	32.2	25.88
72	—	—	—	—	—	3025	23.8	42.05
110	50	892	52.7	28.2	8.71	6284	17.5	87.35
110	60	703	58.2	30	6.9	—	—	—
120	60	892	53.3	27.5	8.21	—	—	—
125	—	—	—	—	—	7259	17.2	100.90
127	50	1122	45.7	24.4	11.61	—	—	—
208	60	3145	30.8	15.9	24.66	—	—	—
220	50	4356	26.4	14.1	34.85	27038	8.1	375.83
220	60	3577	29.1	15	27.59	—	—	—
230	50	4356	25.2	13.5	38.09	—	—	—
230	60	3577	27.8	14.3	30.15	—	—	—
240	50	4356	24.2	12.9	41.47	27038	8.9	375.83
240	60	3577	26.7	13.8	32.83	—	—	—

Plug-in relays

RH control relays
with 4 C/O contacts for control circuit : \sim or ---

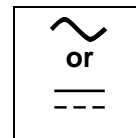

RHT-418E

Time delay relays - On-delay (1)

Description	Control circuit voltage	Timing range	Basic reference complete with code indicating control voltage (2)	Normal voltages	Weight kg
Relays with normal contacts	12...127 V (3) 50 Hz, 60 Hz, ---	0.2...300 s	RHT-418●	B E F	0.130
		1.25 s...40 min	RHT-4138●	B E F	0.130
	220 V, 240 V 50 Hz, 60 Hz	0.2...300 s	RHT-411●	M	0.130
		1.25 s...40 min	RHT-4131●	M	0.130
Relays with low level contacts	12...127 V (3) 50 Hz, 60 Hz, ---	0.2...300 s	RHT-428●	B E F	0.130
		1.25 s...40 min	RHT-4238●	B E F	0.130
	220 V, 240 V 50 Hz, 60 Hz	0.2...300 s	RHT-421●	M	0.130
		1.25 s...40 min	RHT-4231●	M	0.130

Time delay relays - Off-delay (1)

Relays with normal contacts	12...127 V (3) 50 Hz, 60 Hz, ---	0.2...300 s	RHR-418●	B E F	0.130
		1.25 s...40 min	RHR-4138●	B E F	0.130
	220 V, 240 V 50 Hz, 60 Hz	0.2...300 s	RHR-411●	M	0.130
		1.25 s...40 min	RHR-4131●	M	0.130
Relays with low level contacts	12...127 V (3) 50 Hz, 60 Hz, ---	0.2...300 s	RHR-428●	B E F	0.130
		1.25 s...40 min	RHR-4238●	B E F	0.130
	220 V, 240 V 50 Hz, 60 Hz	0.2...300 s	RHR-421●	M	0.130
		1.25 s...40 min	RHR-4231●	M	0.130

(1) Relay fitted with interference suppression coil with built-in diode.

(2) Standard control circuit voltages.

Volts	12	24	42	48	60	72	110	125	127	220	240
50 Hz, 60 Hz and ---	J	B	D	E	P	EN	F	G	G	—	—
50 Hz and 60 Hz	—	—	—	—	—	—	—	—	—	M	U

(3) These products will not operate on \sim 12 V.

Plug-in relays

RH type PLC relays
with 4 C/O contacts for control circuit \sim or --- current

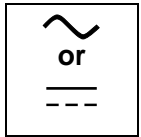

RHE-418E



RHC-418E

Pulse on energisation relays (200 ms) (1)

Description	Control circuit voltage	Basic reference complete with code indicating control voltage (2)	Normal voltages	Weight kg
-------------	-------------------------	---	-----------------	-----------

On energisation

Relays with normal contacts	12...127 V (3) 50 Hz, 60 Hz, ---	RHE-418●	B E F	0.130
-----------------------------	--	-----------------	--------------	-------

	220 V, 240 V 50 Hz, 60 Hz	RHE-411●	M	0.130
--	------------------------------	-----------------	----------	-------

Relays with low level contacts	12...127 V (3) 50 Hz, 60 Hz, ---	RHE-428●	B E F	0.130
--------------------------------	--	-----------------	--------------	-------

	220 V, 240 V 50 Hz, 60 Hz	RHE-421●	M	0.130
--	------------------------------	-----------------	----------	-------

On de-energisation

Relays with normal contacts	12...127 V (3) 50 Hz, 60 Hz, ---	RHD-418●	B E F	0.130
-----------------------------	--	-----------------	--------------	-------

	220 V, 240 V 50 Hz, 60 Hz	RHD-411●	M	0.130
--	------------------------------	-----------------	----------	-------

Relays with low level contacts	12...127 V (3) 50 Hz, 60 Hz, ---	RHD-428●	B E F	0.130
--------------------------------	--	-----------------	--------------	-------

	220 V, 240 V 50 Hz, 60 Hz	RHD-421●	M	0.130
--	------------------------------	-----------------	----------	-------

Flashing relays (adjustable symmetrical flashing time) (1)

Description	Control circuit voltage	Flashing time	Basic reference complete with code indicating control voltage (2)	Normal voltages	Weight kg
-------------	-------------------------	---------------	---	-----------------	-----------

Relays with normal contacts	12...127 V (3) 50 Hz, 60 Hz, ---	0.5...5 s	RHC-418●	B E F	0.130
-----------------------------	--	-----------	-----------------	--------------	-------

		2...30 s	RHC-4198●	B E F	0.130
--	--	----------	------------------	--------------	-------

	220 V, 240 V 50 Hz, 60 Hz	0.5...5 s	RHC-411●	M	0.130
--	------------------------------	-----------	-----------------	----------	-------

		2...30 s	RHC-4191●	M	0.130
--	--	----------	------------------	----------	-------

(1) Relay fitted with interference suppression coil with built-in diode.

(2) Standard control circuit voltages.

Volts	12	24	42	48	60	72	110	125	127	220	240
50 Hz, 60 Hz and ---	J	B	D	E	P	EN	F	G	G	—	—
50 Hz and 60 Hz	—	—	—	—	—	—	—	—	—	M	U

(3) These products will not operate on \sim 12 V.

Plug-in relays



RH type PLC relays

Accessories

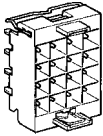
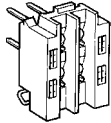
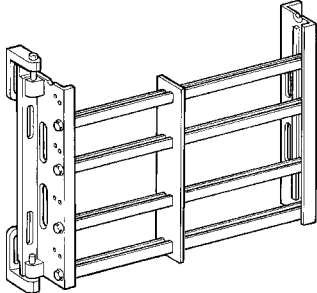
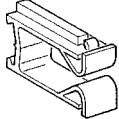

Accessories for back wiring

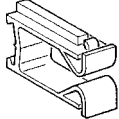
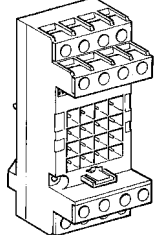
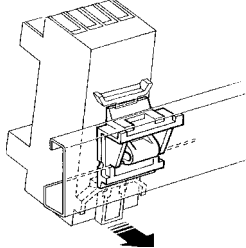
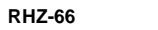
Description	Sold in lots of	Unit reference	Weight kg
 RHZ-11 Sockets (Markable with 3 ABR clip-in characters)	With 2.8 x 0.5 mm tag for soldering or Faston connectors	10	RHZ-11 0.020
	With 0.8 x 1.6 x 22 mm pins for wire wrap or termi-point	10	RHZ-12 0.020
	With 0.8 x 0.8 x 4.3 mm solder pins on 7.62 mm centres	10	RHZ-13 0.020
 RHZ-15 Adaptor 4 terminals for "back-front" connection	Back : 4 tags 2.8 x 0.5 mm and 4 pins 0.6 x 1.6 x 22 mm Front : 4 screw terminals for 2 x 2.5 mm ² wires	1	RHZ-15 0.025
 RHZ-71 Hinged modular Chassis supplied in kit form	For 12 sockets or adaptors	1	RHZ-70 0.450
	For 21 sockets or adaptors	1	RHZ-71 0.500
	For 30 sockets or adaptors	1	RHZ-72 0.600
	For 36 sockets or adaptors (on 19 inch chassis)	1	RHZ-73 0.650
 RHZ-68 Cable clip	For mounting on hinged chassis	10	RHZ-68 0.010

Accessories for front wiring

 RHZ-21 Sockets (Protected against direct finger contact and markable with 4 AB1 clip-in characteristics)	Screw terminals for 2 x 2.5 mm ² wires	1	RHZ-21 0.100
	With double tags 2.8 x 0.5 for Faston connectors	1	RHZ-22 0.080
	With double tags 4.8 x 0.8 for Faston connectors	1	RHZ-24 0.085
 RHZ-42 Socket integrated wiring	For making up a sequence	1	RHZ-42 0.080
 RHZ-25 Termination adaptor 4 terminals for front-back* connection	Top connectors : 4 tags 2.8 x 0.5 mm and 4 pins 0.8 x 1.6 x 22 mm	1	RHZ-25 0.040
	Bottom connection : 4 screw terminals (protected against direct finger contact) for 2 x 2.5 mm ² wires		
 RHZ-66 Mounting adaptor	For mounting sockets and termination adaptors on  rail	10	RHZ-66 0.005

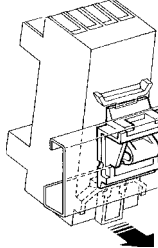
Accessories for suppressors and for marking

 RHZ-32 Accessories for suppressors	RC suppressor for relays 12...220 V	With flexible cable	10	RHZ-32 0.008
		With rigid cable	10	RHZ-33 0.008
 RHZ-63 Accessories for marking	Self-adhesive labels 7 x 13 mm	Pack of 980 labels	1	RHZ-63 0.010
	Clip-in characters (3 or 4 maximum)	Strips of 10 identical numbers from 0 to 9	25 identical strips	AB1-R● (1) 0.002
		Strips of 10 identical capital letters A to Z	25 identical strips	AB1-G● (1) 0.002

(1) To order, replace the &bullet; in the reference with the required character.

Plug-in relays

RH type PLC relays
Accessories

Accessories for back wiring

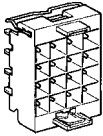
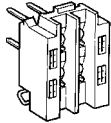
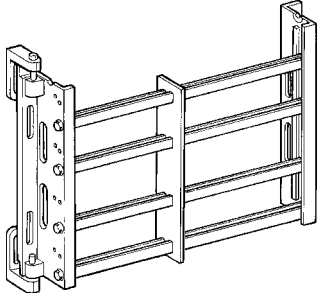
Description	Sold in lots of	Unit reference	Weight kg
 RHZ-11 Sockets (Markable with 3 ABR clip-in characters)	With 2.8 x 0.5 mm tag for soldering or Faston connectors	10	RHZ-11 0.020
	With 0.8 x 1.6 x 22 mm pins for wire wrap or termi-point	10	RHZ-12 0.020
	With 0.8 x 0.8 x 4.3 mm solder pins on 7.62 mm centres	10	RHZ-13 0.020
 RHZ-15 Adaptor 4 terminals for "back-front" connection	Back : 4 tags 2.8 x 0.5 mm and 4 pins 0.6 x 1.6 x 22 mm	1	RHZ-15 0.025
	Front : 4 screw terminals for 2 x 2.5 mm ² wires		
	Hinged modular Chassis supplied in kit form		
	For 12 sockets or adaptors	1	RHZ-70 0.450
	For 21 sockets or adaptors	1	RHZ-71 0.500
	For 30 sockets or adaptors	1	RHZ-72 0.600
	For 36 sockets or adaptors (on 19 inch chassis)	1	RHZ-73 0.650
 RHZ-71 Cable clip	For mounting on hinged chassis	10	RHZ-68 0.010

Accessories for front wiring

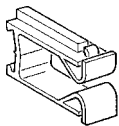
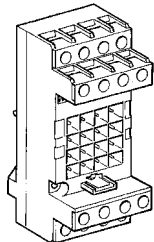
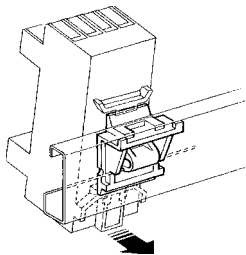
 RHZ-68 Sockets (Protected against direct finger contact and markable with 4 AB1 clip-in characteristics)	Screw terminals for 2 x 2.5 mm ² wires	1	RHZ-21 0.100
	With double tags 2.8 x 0.5 for Faston connectors	1	RHZ-22 0.080
	With double tags 4.8 x 0.8 for Faston connectors	1	RHZ-24 0.085
 RHZ-21 Socket integrated wiring	For making up a sequence	1	RHZ-42 0.080
	Termination adaptor 4 terminals for front-back connection	1	RHZ-25 0.040
	Top connectors : 4 tags 2.8 x 0.5 mm and 4 pins 0.8 x 1.6 x 22 mm		
	Bottom connection : 4 screw terminals (protected against direct finger contact) for 2 x 2.5 mm ² wires		
 RHZ-66 Mounting adaptor	For mounting sockets and termination adaptors on rail	10	RHZ-66 0.005

Accessories for suppressors and for marking

Accessories for suppressors	RC suppressor for relays 12...220 V	With flexible cable	10	RHZ-32 0.008
		With rigid cable	10	RHZ-33 0.008
Accessories for marking	Self-adhesive labels 7 x 13 mm	Pack of 980 labels	1	RHZ-63 0.010
	Clip-in characters (3 or 4 maximum)	Strips of 10 identical numbers from 0 to 9	25 identical strips	AB1-R● (1) 0.002
		Strips of 10 identical capital letters A to Z	25 identical strips	AB1-G● (1) 0.002

(1) To order, replace the • in the reference with the required character.

Relays
RHN

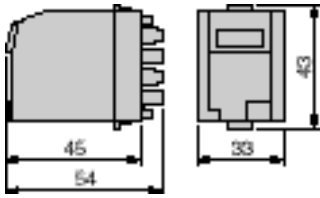

RHK

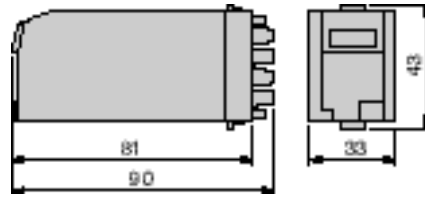

RHT, RHR, RHE, RHD, RHC

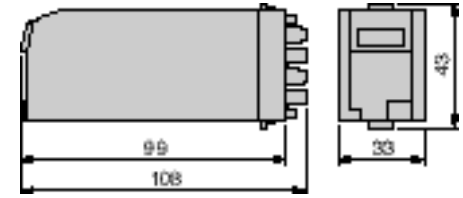

Sockets
RHZ-11

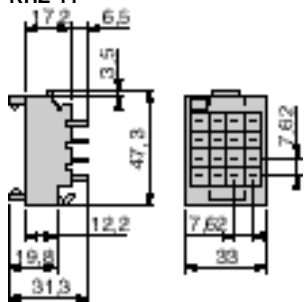

RHZ-12

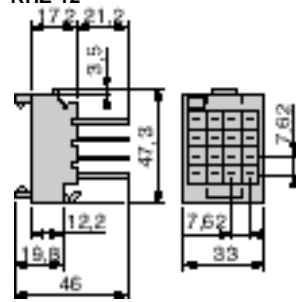

RHZ-13

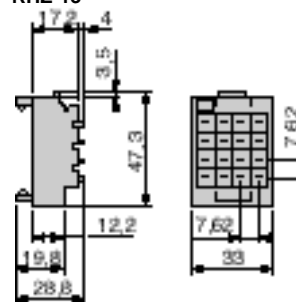

Termination adaptor
RHZ-15

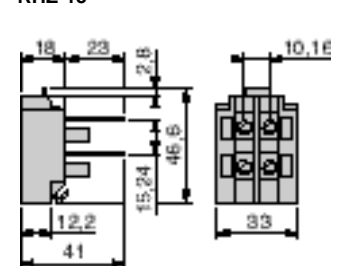

Sockets
RHZ-21

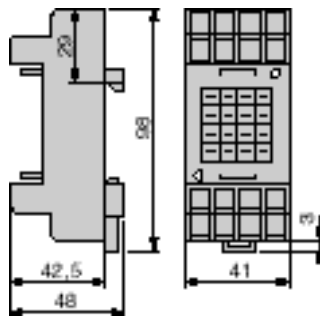

RHZ-22

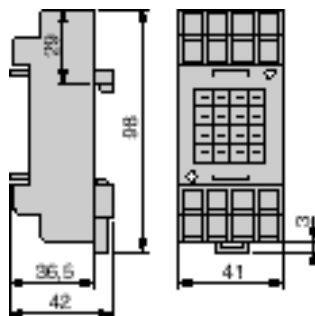

RHZ-24

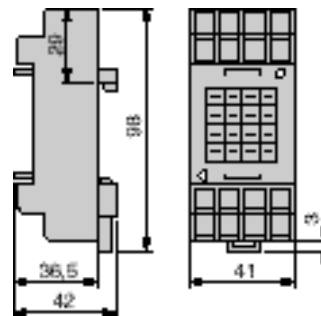

Termination adaptor
RHZ-25

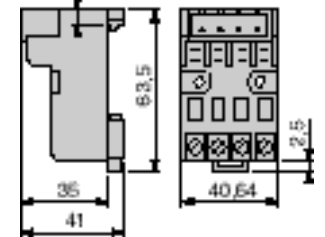

Relay circuit diagrams
RHN



RHK



RHC



RHT

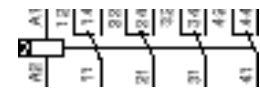

RHE



RHD

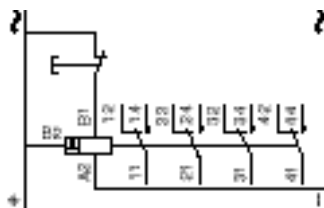

RHR

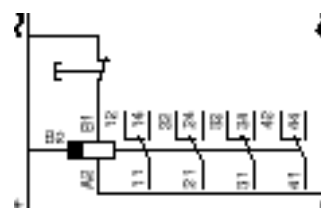

Maintain correct polarity when connecting for d.c. control.

Plug-in relays

RH control relays

Sockets and termination adaptors for front wiring

Sockets
RHZ-21
Panel mounted

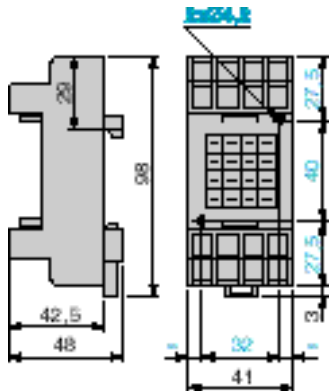

RHZ-22, RHZ-24
Panel mounted

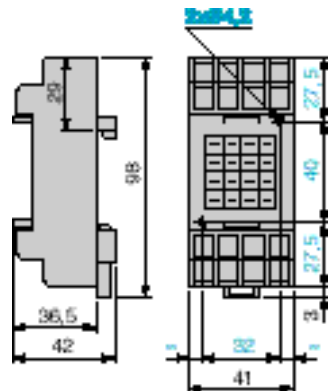

Clipped directly
onto one AM1-DP rail

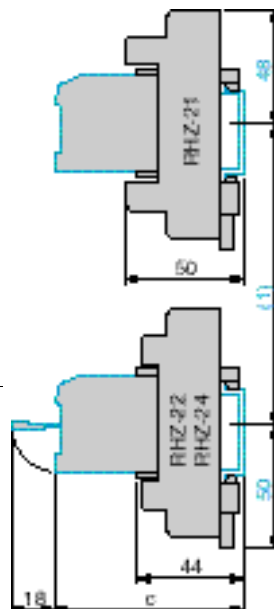

Clipped onto one DZ5-MB rail
using adaptor RHZ-66

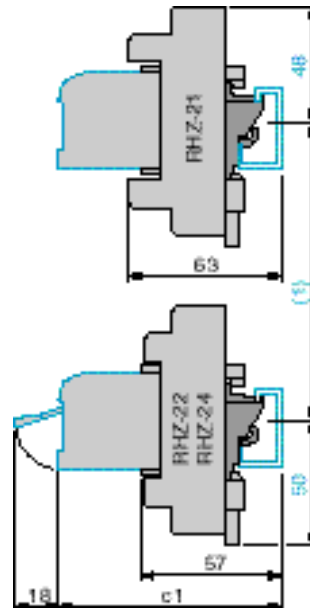

RHZ-42
Panel mounted

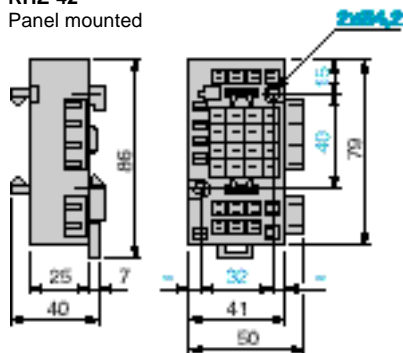

With relay	RHN	RHK	RHT	RHR	RHE	RHD	RHC
c	82	118	136	136	136	136	136
c1	95	131	149	149	149	149	149

(1) 110 min

Termination adaptor
RHZ-25
Panel mounted

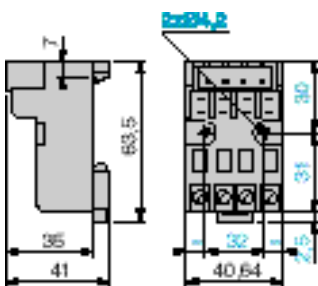

Clipped directly
onto one AM1-DP rail

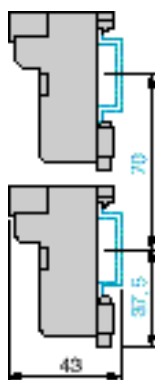

Clipped onto one DZ5-MB rail
using adaptor RHZ-66

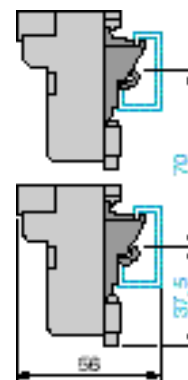

Mounting the relay on the socket
Instant clip-in locking

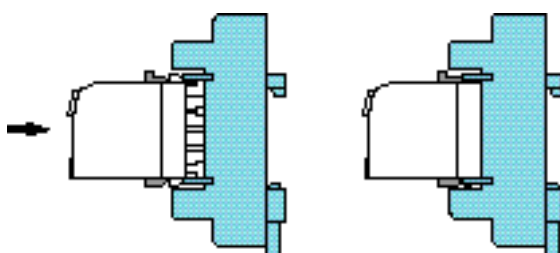

Release by pressing tabs

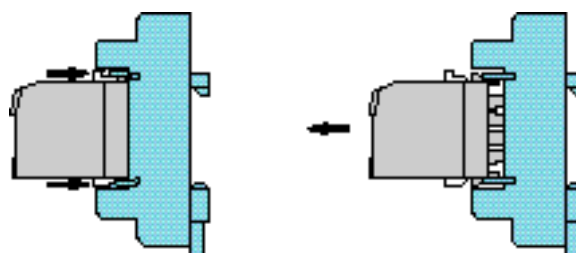

Plug-in relays

RH control relays
Sockets and termination adaptors for back wiring

Sockets
RHZ-11

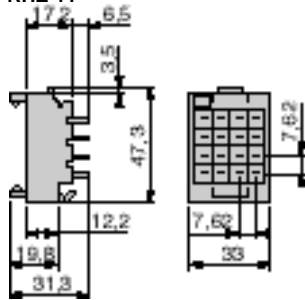

RHZ-12

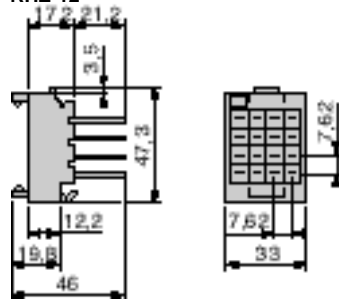

Termination adaptor
RHZ-15

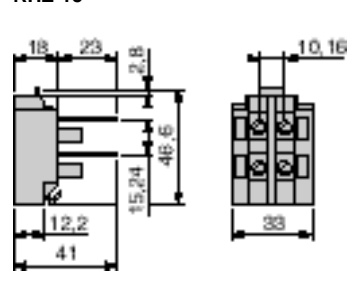

Mounted directly
on slotted plate

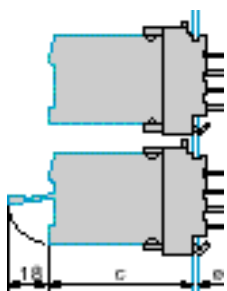
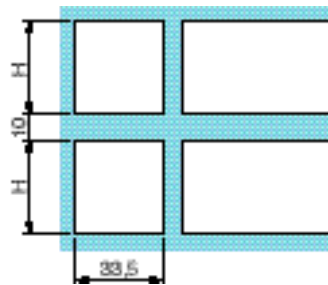

Plate cut-out



e : 1 mm (min) to 2 mm (max)

e (1) 1 mm 2 mm

With relays **RHN RHK RHT to RHC**
c 57 93 111

H 35.7 ±0.15 36.7 ±0.15
(1) plate thickness

Mounting directly on hinged modular chassis RHZ-7p

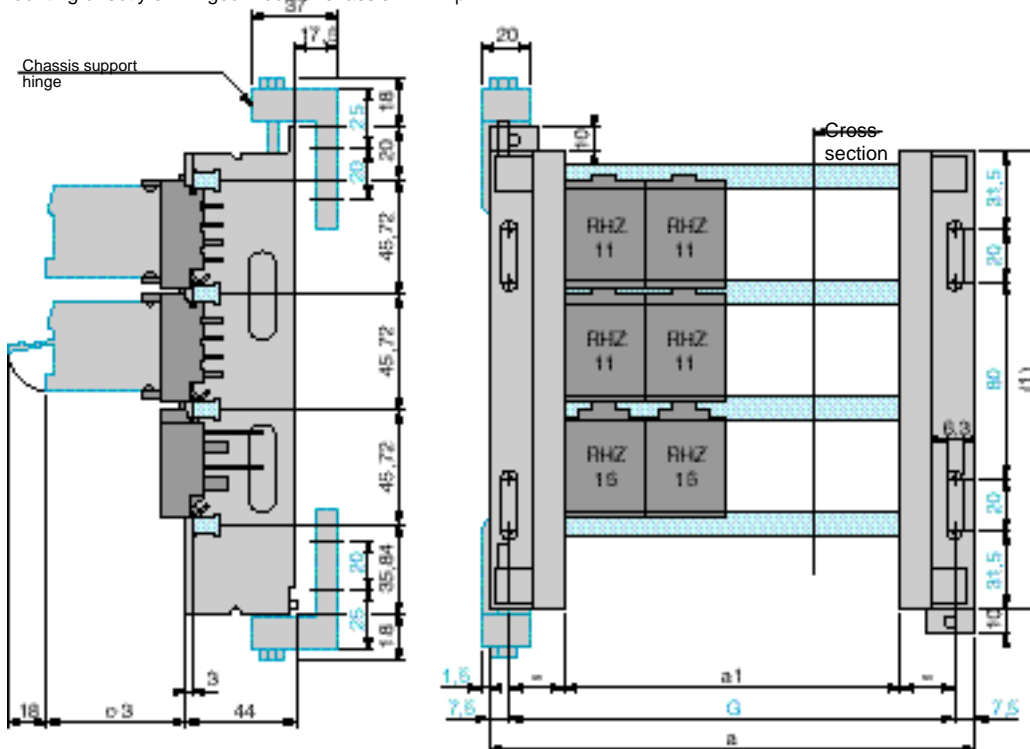

	RHZ-70	RHZ-71	RHZ-72	RHZ-73
a	215	315	415	480
a1	155	255	355	420
G	200	300	400	465

(1) modular 183

Presentation :
pages 28001/2 to 28001/5

Characteristics :
pages 28002/6 to 28002/7

References :
page 28003/5

Plug-in relays

RH control relays

Sockets and termination adaptors for back wiring

Socket RHZ-13

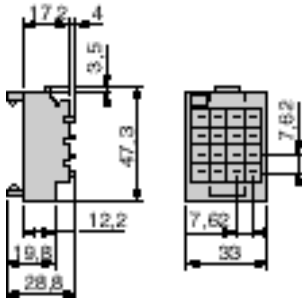

Mounting on printed circuit board

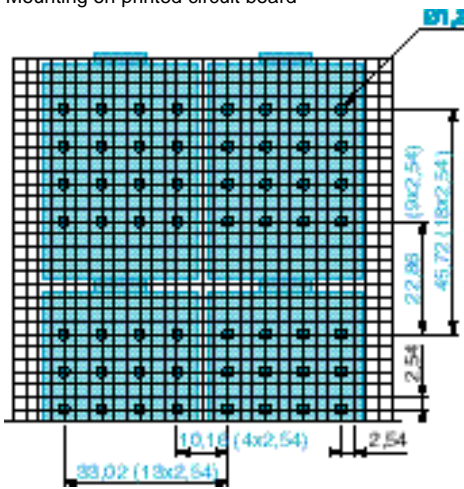

Socket mounting

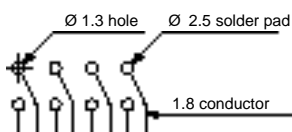

On all printed circuit boards with pin spacing of 2.54 mm.

The 7.62 mm spacing between pins (3 x 2.54 mm) allows space between rows of pins for a 1.8 mm x 70 m conductor with a capacity of 5 A at 240 V a