

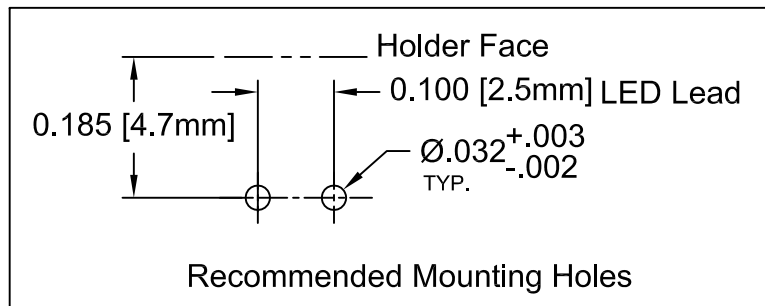

ITEM	Q'TY	PART NUMBER	PART DESCRIPTION
1	1	H-101C	T-1 (3mm) LED Holder, 90° Mount
2	1	3XX-S	T-1 (3mm) N-Flange Shouldered LED, See Page 2 & 3

REV.	DESCRIPTION	DATE	APPROVED
B	Added H101CRDL	02/14/07	M. C.
C	Holder Update, Added LEDs	10/04/07	M. C.
D	LED Package Change to 3XX-S LEDs	12/14/07	M. C.
E	Updated LED specs.	10/08/08	M. C.
F	Added Water Clear LED specs.	02/05/09	T. Y.

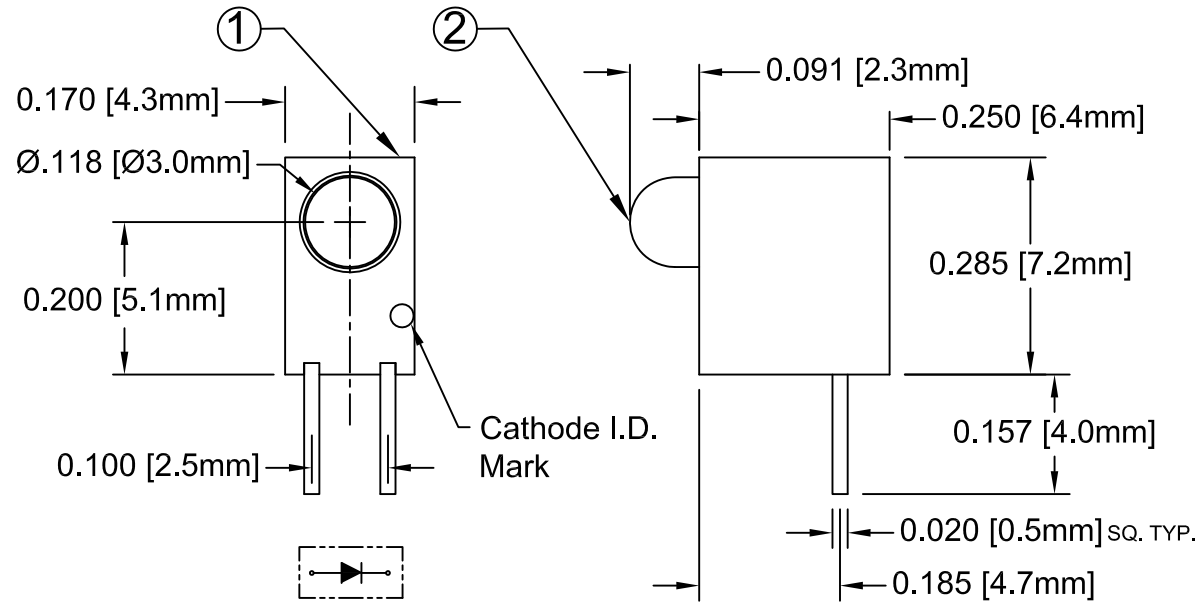

ABSOLUTE MAXIMUM RATINGS (Ta=25° C)



REVERSE VOLTAGE _____	5V
REVERSE CURRENT _____	100uA
OPERATING TEMPERATURE RANGE _____	-25° C - 85° C
STORAGE TEMPERATURE _____	-30° C - 100° C
LEAD SOLDERING TEMPERATURE(1/16" FROM BODY) _____	260° C FOR 5 SECONDS

STANDARD TOLERANCE (UNLESS OTHERWISE SPECIFIED)		 4 THOMAS, IRVINE, CA. 92618 TEL: (949) 951-8808 FAX: (949) 951-3974	
DECIMALS	ANGULAR		
.X ±.1	X° ± 1°		TITLE: T-1 (3MM)
.XX ±.02			90° SINGLE-LEVEL LED ASSEMBLY
.XXX ±.010			REVISION: F
DESIGNED: Ty Yin	DATE: 03/05/04	PART NO: H101CXX	REVISION: F
CHECKED: D. Green	DATE: 03/05/04	CAGE CODE : 32559	SHEET # 1 OF 3

CAD GENERATED DOCUMENT, DO NOT MEASURE DRAWING.

REV.	DESCRIPTION	DATE	APPROVED
	SEE SHEET#1.		



LED Assy. No.	Peak Wave Length λ_p (nm)	Emitted Color	Lens Appearance	Electro-Optical Data				Viewing Angle $2\theta_{1/2}$ (Deg)	LED P/N
				If (mA)	Vf (V)		Iv (mcd)		
				Typ.	Typ.	Max.	Typ.		
STANDARD				Data @ 20mA					
H101CBWD	430	BLUE	DIFFUSED	20	4.0	4.5	10	40	3BWD-S
H101CBWC	430	BLUE	WATER CLEAR	20	4.0	4.5	25	30	3BWC-S
H101CGD	568	GREEN	DIFFUSED	20	2.1	2.8	25	40	3GD-S
H101CGC	568	GREEN	WATER CLEAR	20	2.1	2.8	40	30	3GC-S
H101CYD	590	YELLOW	DIFFUSED	20	2.0	2.8	20	40	3YD-S
H101CYC	590	YELLOW	WATER CLEAR	20	2.0	2.8	40	30	3YC-S
H101CHD	625	HE RED	DIFFUSED	20	2.0	2.8	30	40	3HD-S
H101CHC	625	HE RED	WATER CLEAR	20	2.0	2.8	50	30	3HC-S
H101CRD	700	RED	DIFFUSED	20	2.1	2.8	2	40	3RD-S
H101CRC	700	RED	WATER CLEAR	20	2.1	2.8	3	30	3RC-S
LOW CURRENT				Data @ 2mA					
H101CGDL	568	GREEN	DIFFUSED	2	2.1	2.6	2	40	3GDL-S
H101CYDL	590	YELLOW	DIFFUSED	2	2.0	2.6	2	40	3YDL-S
H101CHDL	625	HE RED	DIFFUSED	2	2.0	2.6	3	40	3HDL-S
H101CRDL	700	RED	DIFFUSED	2	2.1	2.6	1	40	3RDL-S
5 VOLT				Data @ 5V					
H101CGD5V	568	GREEN	DIFFUSED	8	-	5.0	25	40	3GD5V-S
H101CYD5V	590	YELLOW	DIFFUSED	8	-	5.0	20	40	3YD5V-S
H101CHD5V	625	HE RED	DIFFUSED	8	-	5.0	30	40	3HD5V-S

STANDARD TOLERANCE (UNLESS OTHERWISE SPECIFIED) $\pm 10\%$ ALL VALUES ANGULAR		 BIVAR [®] 4 THOMAS, IRVINE, CA. 92618 TEL: (949) 951-8808 FAX: (949) 951-3974	
			
DESIGNED: Ty Yln	DATE: 03/05/04	PART NO: H101CXX	REVISION: F
CHECKED: D. Green	DATE: 03/05/04	CAGE CODE: 32559	SHEET # 2 OF 3
CAD GENERATED DOCUMENT, DO NOT MEASURE DRAWING.			

REV.	DESCRIPTION	DATE	APPROVED
	SEE SHEET#1.		

LED Assy. No.	Peak Wave Length λ_p (nm)	Emitted Color	Lens Appearance	Electro-Optical Data @ 20mA				Viewing Angle $2\theta_{1/2}$ (Deg)	LED P/N
				If (mA)	Vf (V)		Iv (mcd)		
				Typ.	Typ.	Max.	Typ.		
H101CUBWC0.6K	466	BLUE	WATER CLEAR	20	4.0	4.5	600	30	3UBWC-0.6K-S
H101CBWD0.245	470	BLUE	DIFFUSED	20	4.0	4.5	200	40	3BWD0.245-S
H101CUTC	500	TURQUOISE	WATER CLEAR	20	3.5	4.0	800	30	3UTC-S
H101CEGC2.030	525	GREEN	WATER CLEAR	20	4.0	4.5	2500	30	3EGC2.030-S
H101CUGC	570	GREEN	WATER CLEAR	20	2.1	2.4	200	30	3UGC-S
H101CSUGC	570	GREEN	WATER CLEAR	20	2.1	2.4	300	30	3SUGC-S
H101CUYC	590	YELLOW	WATER CLEAR	20	2.0	2.4	300	30	3UYC-S
H101CSUYC	590	YELLOW	WATER CLEAR	20	2.0	2.4	400	30	3SUYC-S
H101CUUYC	590	YELLOW	WATER CLEAR	20	2.0	2.4	600	30	3UUYC-S
H101CUOC	625	ORANGE	WATER CLEAR	20	1.8	2.4	300	30	3UOC-S
H101CSUOC	625	ORANGE	WATER CLEAR	20	1.8	2.4	400	30	3SUOC-S
H101CURC	645	RED	WATER CLEAR	20	1.7	2.4	200	30	3URC-S
H101CSURC	640	RED	WATER CLEAR	20	1.8	2.4	200	30	3SURC-S
H101CSR	645	RED	DIFFUSED	20	1.7	2.4	40	40	3SRD-S

LED Assy. No.	Chromaticity Coordinates	Emitted Color	Lens Appearance	Electro-Optical Data @ 20mA				Viewing Angle $2\theta_{1/2}$ (Deg)	LED P/N
				If (mA)	Vf (V)		Iv (mcd)		
				Typ.	Typ.	Max.	Typ.		
H101CUWC0.6K	X=.3, Y=.31	WHITE	WATER CLEAR	20	3.2	3.8	1000	30	3UWC-0.6K-S
H101CUWC1.530	X=.3, Y=.31	WHITE	WATER CLEAR	20	3.2	3.8	2000	30	3UWC1.530-S

STANDARD TOLERANCE (UNLESS OTHERWISE SPECIFIED) $\pm 10\%$ ALL VALUES ANGULAR		 BIVAR [®] 4 THOMAS, IRVINE, CA. 92618 TEL: (949) 951-8808 FAX: (949) 951-3974	
			
DESIGNED: Ty Yln	DATE: 03/05/04	TITLE: T-1 (3MM) 90° SINGLE-LEVEL LED ASSEMBLY	REVISION: F
CHECKED: D. Green	DATE: 03/05/04	PART NO: H101CXX	CAGE CODE : 32559 SHEET # 3 OF 3
CAD GENERATED DOCUMENT, DO NOT MEASURE DRAWING.			